

**GUTE  
SCHRAUBEN** 



**TORNILLERIA**



# PVC DIN 7504-P

**GUTE  
SCHRAUBEN**

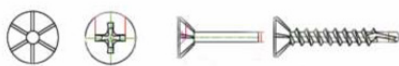

ensamblaje de chapas  
metal panels



perfiles de chapa  
metal elements



carpintería aluminio  
aluminium windows



## TORN. GS. PVC 7504-P

				REF.	€
3,9 x 13	BOLSA	4000	3,90	T1507	-
3,9 x 16	BOLSA	4000	4,40	T1508	-
3,9 x 19	BOLSA	4000	5,14	T1509	-
3,9 x 22	BOLSA	4000	5,97	T1510	-
3,9 x 25	BOLSA	4000	6,53	T1503	0,048
3,9 x 32	BOLSA	4000	7,96	T1504	0,055
3,9 x 38	BOLSA	4000	9,43	T1505	-
4,2 x 19	BOLSA	4000	6,00	T1515	-
4,2 x 22	BOLSA	4000	7,00	T1516	-
4,2 x 25	BOLSA	4000	7,48	T1517	-
4,2 x 32	BOLSA	4000	9,41	T1518	-
4,2 x 38	BOLSA	4000	11,20	T1519	-
4,2 x 45	BOLSA	4000	13,03	T1520	-
4,2 x 50	BOLSA	4000	14,60	T1521	-
4,8 x 19	BOLSA	4000	8,31	T1522	-
4,8 x 22	BOLSA	4000	9,28	T1523	-
4,8 x 25	BOLSA	4000	10,52	T1524	-
4,8 x 32	BOLSA	4000	13,02	T1525	-
4,8 x 38	BOLSA	4000	15,12	T1526	-
4,8 x 45	BOLSA	4000	17,90	T1527	-
4,8 x 50	BOLSA	4000	19,68	T1528	-
4,8 x 60	BOLSA	4000	23,81	T1529	-
4,8 x 70	BOLSA	4000	27,68	T1530	-
4,8 x 80	BOLSA	4000	31,12	T1531	-
4,8 x 100	BOLSA	4000	38,00	T1532	-

## TORN. GS. PVC 7504-P

			REF.	€	
3,9 x 13	CAJA	1000	0,97	T1555	-
3,9 x 16	CAJA	1000	1,10	T1533	-
3,9 x 19	CAJA	1000	1,28	T1534	-
3,9 x 22	CAJA	1000	1,49	T1535	-
3,9 x 25	CAJA	1000	1,63	T1513	0,048
3,9 x 32	CAJA	1000	1,99	T1514	0,055
3,9 x 38	CAJA	1000	2,36	T1536	-
4,2 x 19	CAJA	1000	1,50	T1537	-
4,2 x 22	CAJA	1000	1,75	T1538	-
4,2 x 25	CAJA	1000	1,87	T1539	-
4,2 x 32	CAJA	1000	2,35	T1540	-
4,2 x 38	CAJA	1000	2,80	T1541	-
4,2 x 45	CAJA	1000	3,26	T1542	-
4,2 x 50	CAJA	1000	3,65	T1543	-
4,8 x 19	CAJA	1000	2,08	T1544	-
4,8 x 22	CAJA	1000	2,32	T1545	-
4,8 x 25	CAJA	1000	2,63	T1546	-
4,8 x 32	CAJA	1000	3,26	T1547	-
4,8 x 38	CAJA	1000	3,78	T1548	-
4,8 x 45	CAJA	1000	4,48	T1549	-
4,8 x 50	CAJA	1000	4,92	T1556	-
4,8 x 60	CAJA	1000	5,95	T1551	-
4,8 x 70	CAJA	1000	6,92	T1552	-
4,8 x 80	CAJA	1000	7,78	T1553	-
4,8 x 100	CAJA	1000	9,50	T1554	-

# PVC PUNTA BROCA METRICA OVAL

**GUTE  
SCHRAUBEN**

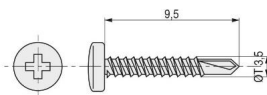

ensamblaje de chapas  
metal panels



perfiles de chapa  
metal elements



carpintería aluminio  
aluminium windows



## TORN. GS. PVC P/BRO MTR. OVAL

				REF.	€
3,9 x 16	BOLSA	4000	4,70	T1501	0,033
3,9 x 19	BOLSA	4000	5,06	T1502	0,038
3,9 x 16	CAJA	1000	1,17	T1511	0,034
3,9 x 19	CAJA	1000	1,26	T1512	0,038

# PVC DOBLE ROSCA OVAL

GUTE  
SCHRAUBEN

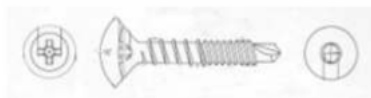

ensamblaje de chapas  
metal panels



perfiles de chapa  
metal elements



carpintería aluminio  
aluminium windows



## TORN. GS. PVC D/ROSCA OVAL

				REF.	€
4,2 x 19	BOLSA	4000	4,86	T1714	-
4,2 x 25	BOLSA	4000	6,22	T1716	-
4,2 x 32	BOLSA	4000	8,11	T1720	0,070
4,2 x 38	BOLSA	4000	9,55	T1729	-
4,8 x 32	BOLSA	4000	11,85	T1717	-
4,8 x 45	BOLSA	4000	16,17	T1718	-
4,2 x 19	CAJA	1000	1,22	T1719	-
4,2 x 25	CAJA	1000	1,56	T1723	-
4,2 x 32	CAJA	1000	2,03	T1725	-
4,2 x 38	CAJA	1000	2,39	T1730	-
4,8 x 32	CAJA	1000	2,96	T1724	-
4,8 x 45	CAJA	1000	4,04	T1728	-

# PVC DIN 907 OVAL

GUTE  
SCHRAUBEN



## TORN. GS. PVC OVAL



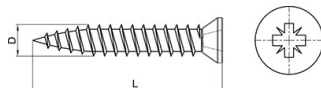

				REF.	€
4 x 25	BOLSA	4000	6,80	T1602	0,036
4 x 32	BOLSA	4000	5,28	T1603	0,041
4 x 38	BOLSA	4000	7,10	T1604	0,050
4 x 25	CAJA	1000	1,70	T1612	0,036
4 x 32	CAJA	1000	1,32	T1613	0,041
4 x 38	CAJA	1000	1,78	T1614	0,050

# PVC HIGH LOW

GUTE  
SCHRAUBEN®



## TORN. GS. PVC HLO



				REF.	€
3,9 x 19	· BOLSA	4000	4,20	T1620	0,028
3,9 x 22	BOLSA	4000	4,33	T1605	-
3,9 x 25	· BOLSA	4000	5,15	T1621	0,035
3,9 x 32	BOLSA	4000	6,46	T1606	-
3,9 x 38	BOLSA	4000	7,46	T1607	-
4,2 x 32	BOLSA	4000	7,82	T1608	-
4,2 x 38	BOLSA	4000	8,97	T1609	-
4,2 x 45	BOLSA	4000	10,44	T1610	-
4,8 x 38	BOLSA	4000	13,21	T1627	-
3,9 x 19	· CAJA	1000	1,05	T1625	0,028
3,9 x 22	CAJA	1000	1,08	T1615	-
3,9 x 25	· CAJA	1000	1,23	T1626	0,035
3,9 x 32	CAJA	1000	1,62	T1616	-
3,9 x 38	CAJA	1000	1,87	T1617	-
4,2 x 32	CAJA	1000	1,95	T1618	-
4,2 x 38	CAJA	1000	2,24	T1619	-
4,2 x 45	CAJA	1000	2,61	T1622	-
4,8 x 38	CAJA	1000	3,30	T1623	-

# PVC HORMIGON

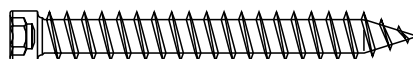
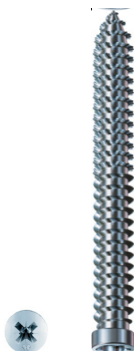
GUTE  
SCHRAUBEN®



## TORN. GS. HORMIG.

			REF.	€	
7,5 x 42	CAJA	100	0,76	T1731	-
7,5 x 60	CAJA	100	1,09	T1732	-
7,5 x 72	· CAJA	100	1,29	T1703	0,59
7,5 x 80	CAJA	100	1,44	T1733	-
7,5 x 92	· CAJA	100	1,65	T1705	0,75
7,5 x 100	CAJA	100	1,83	T1734	-
7,5 x 112	· CAJA	100	2,04	T1707	0,92
7,5 x 120	· CAJA	100	2,18	T1708	0,97
7,5 x 132	CAJA	100	2,42	T1735	-
7,5 x 150	· CAJA	100	2,74	T1710	1,23
7,5 x 180	· CAJA	100	2,96	T1711	2,16
7,5 x 200	CAJA	100	3,28	T1736	-
7,5 x 220	CAJA	100	3,98	T1737	-





  
GUTE  
SCHRAUBEN

## TAPON GS. PVC P/HORMIGON



			REF.	€
1.000	13 / 4	Blanco	H8850	0,22
1.000	13 / 4	Negro	H8851	0,22





## TORN. GS. PVC P/JUNQUILLO 4 x 16

	TIPO			REF.	€
250	PH	5,5 x 12	Zinc	T1715	0,32



Tornillo **junquillo** KO zincado (Kömmerling)

	TIPO			REF.	€
250	KO	5,5 x 10	Zinc	56525	0,38



Tornillo **junquillo** RH zincado (Rehau)

	TIPO			REF.	€
250	RH	5,5 x 12	Zinc	56526	1,18

Tornillo **junquillo** TY zincado (Tyssen)

	TIPO			REF.	€
250	TY	5,5 x 12	Zinc	94466	0,37

Tornillo **junquillo** VK zincado (Veka)

	TIPO			REF.	€
250	VK	4,8 x 9,5	Zinc	30503	0,34









Tornillo DIN 7504-N PH2 zincado



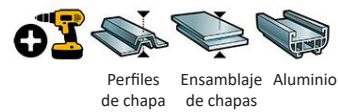
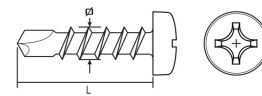

	TIPO			REF.	€
1.000	PH2	3,5 x 9,5	Zinc	H8893	0,011
1.000	PH2	3,5 x 11	Zinc	H8894	0,009
1.000	PH2	3,5 x 13	Zinc	H8895	0,010
1.000	PH2	3,5 x 16	Zinc	H8896	0,010
1.000	PH2	3,5 x 19	Zinc	H8897	0,012
1.000	PH2	3,5 x 22	Zinc	H8898	0,014
500	PH2	3,5 x 25	Zinc	H8899	0,014
500	PH2	3,5 x 32	Zinc	H8900	0,017
1.000	PH2	3,9 x 13	Zinc	H8901	0,012
1.000	PH2	3,9 x 16	Zinc	H8902	0,005
1.000	PH2	3,9 x 19	Zinc	H8903	0,020
500	PH2	3,9 x 25	Zinc	H8904	0,017
500	PH2	3,9 x 32	Zinc	H8905	0,020
1.000	PH2	4,2 x 13	Zinc	H8906	0,012
1.000	PH2	4,2 x 16	Zinc	H8907	0,016
1.000	PH2	4,2 x 19	Zinc	H8908	0,015
500	PH2	4,2 x 22	Zinc	H8909	0,018
500	PH2	4,2 x 25	Zinc	H8910	0,018
500	PH2	4,2 x 32	Zinc	H8911	0,021
500	PH2	4,2 x 38	Zinc	H8912	0,036
500	PH2	4,2 x 50	Zinc	H8913	0,032
1.000	PH2	4,8 x 13	Zinc	H8914	0,019
1.000	PH2	4,8 x 16	Zinc	H8915	0,019
1.000	PH2	4,8 x 19	Zinc	H8916	0,021
500	PH2	4,8 x 22	Zinc	H8917	0,024
500	PH2	4,8 x 25	Zinc	H8918	0,025
500	PH2	4,8 x 32	Zinc	H8919	0,031
500	PH2	4,8 x 38	Zinc	H8920	0,044
500	PH2	4,8 x 45	Zinc	H8921	0,037
500	PH2	4,8 x 50	Zinc	H8922	0,043
500	PH2	4,8 x 60	Zinc	H8923	0,080
250	PH2	4,8 x 70	Zinc	H8924	0,115
250	PH2	4,8 x 80	Zinc	H8925	0,093
100	PH2	4,8 x 90	Zinc	H8926	0,168
100	PH2	4,8 x 100	Zinc	H8927	0,132
100	PH2	4,8 x 110	Zinc	H8928	0,140
100	PH2	4,8 x 120	Zinc	H8929	0,147
500	PH2	5,5 x 19	Zinc	H8930	0,030
500	PH2	5,5 x 22	Zinc	H8931	0,031
500	PH2	5,5 x 25	Zinc	H8932	0,032
500	PH2	5,5 x 32	Zinc	H8933	0,040
500	PH2	5,5 x 38	Zinc	H8934	0,045
500	PH2	5,5 x 45	Zinc	H8935	0,049
250	PH2	5,5 x 60	Zinc	H8936	0,069
250	PH2	5,5 x 73	Zinc	H8937	0,082





### Tornillo DIN 7504-N PH2 zincado negro

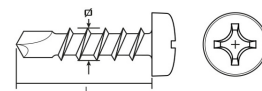

MAREFIX  
FIXING SYSTEMS

	TIPO			REF.	€
1.000	PH2	3,5 x 9,5	Negro	H8938	0,014
1.000	PH2	3,5 x 13	Negro	H8939	0,018
1.000	PH2	3,5 x 16	Negro	H8940	0,017
1.000	PH2	3,5 x 19	Negro	H8941	0,018
1.000	PH2	4,2 x 13	Negro	H8942	0,020
1.000	PH2	4,2 x 16	Negro	H8943	0,022
1.000	PH2	4,2 x 19	Negro	H8944	0,024
500	PH2	4,2 x 25	Negro	H8945	0,030
500	PH2	4,2 x 32	Negro	H8946	0,035
500	PH2	4,2 x 38	Negro	H8947	0,039
1.000	PH2	4,8 x 16	Negro	H8948	0,030
1.000	PH2	4,8 x 19	Negro	H8949	0,012
500	PH2	4,8 x 25	Negro	H8950	0,048
500	PH2	4,8 x 32	Negro	H8951	0,045
500	PH2	4,8 x 38	Negro	H8952	0,070
500	PH2	4,8 x 45	Negro	H8953	0,057
500	PH2	4,8 x 50	Negro	H8954	0,076



### Tornillo DIN 7504-N Torx zincado

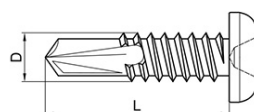

MAREFIX  
FIXING SYSTEMS

	TIPO			REF.	€
1.000	TX	3,5 x 9,5	Zinc	H8955	0,044
1.000	TX	3,5 x 13	Zinc	H8956	0,048
1.000	TX	3,5 x 16	Zinc	H8957	0,052
1.000	TX	3,5 x 19	Zinc	H8958	0,057
1.000	TX	4,2 x 13	Zinc	H8959	0,063
1.000	TX	4,2 x 16	Zinc	H8960	0,068
1.000	TX	4,2 x 19	Zinc	H8961	0,073
500	TX	4,2 x 25	Zinc	H8962	0,090
1.000	TX	4,8 x 16	Zinc	H8963	0,089
1.000	TX	4,8 x 19	Zinc	H8964	0,095
500	TX	4,8 x 25	Zinc	H8965	0,114
500	TX	4,8 x 32	Zinc	H8966	0,132
500	TX	4,8 x 38	Zinc	H8967	0,199
500	TX	4,8 x 45	Zinc	H8968	0,168
500	TX	4,8 x 50	Zinc	H8969	0,180
500	TX	4,8 x 60	Zinc	H8970	0,218
250	TX	4,8 x 70	Zinc	H8971	0,258



### Tornillo DIN 7504-P PH2 zincado negro

MAREFIX  
FIXING SYSTEMS

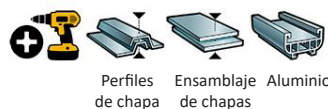
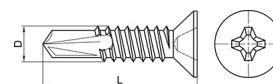

	TIPO			REF.	€
1.000	PH2	3,5 x 13	Negro	H9058	0,014
1.000	PH2	3,5 x 16	Negro	H9059	0,016
1.000	PH2	3,5 x 19	Negro	H9060	0,018
500	PH2	3,5 x 25	Negro	H9061	0,022
1.000	PH2	4,2 x 16	Negro	H9062	0,020
1.000	PH2	4,2 x 19	Negro	H9063	0,023
500	PH2	4,2 x 25	Negro	H9064	0,029
500	PH2	4,2 x 32	Negro	H9065	0,035
500	PH2	4,2 x 38	Negro	H9066	0,047
500	PH2	4,8 x 25	Negro	H9067	0,036
500	PH2	4,8 x 32	Negro	H9068	0,044
500	PH2	4,8 x 38	Negro	H9069	0,055
500	PH2	4,8 x 50	Negro	H9070	0,067









## Tornillo DIN 7504-P PH2 zincado

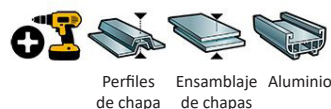
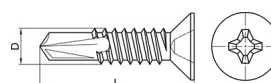

MAREFIX  
FIXING SYSTEMS

	TIPO			REF.	€
1.000	PH2	3,5 x 9,5	Zinc	H8978	0,009
1.000	PH2	3,5 x 11	Zinc	H8979	0,009
1.000	PH2	3,5 x 13	Zinc	H8980	0,009
1.000	PH2	3,5 x 16	Zinc	H8981	0,010
1.000	PH2	3,5 x 19	Zinc	H8982	0,012
1.000	PH2	3,5 x 22	Zinc	H8983	0,013
500	PH2	3,5 x 25	Zinc	H8984	0,014
1.000	PH2	3,9 x 13	Zinc	H8985	0,011
1.000	PH2	3,9 x 16	Zinc	H8986	0,005
1.000	PH2	3,9 x 19	Zinc	H8987	0,010
500	PH2	3,9 x 22	Zinc	H8988	0,015
500	PH2	3,9 x 25	Zinc	H8989	0,015
500	PH2	3,9 x 32	Zinc	H8990	0,018
500	PH2	3,9 x 38	Zinc	H8991	0,021
1.000	PH2	4,2 x 13	Zinc	H8992	0,012
1.000	PH2	4,2 x 16	Zinc	H8993	0,013
1.000	PH2	4,2 x 19	Zinc	H8994	0,014
500	PH2	4,2 x 22	Zinc	H8995	0,016
500	PH2	4,2 x 25	Zinc	H8996	0,018
500	PH2	4,2 x 32	Zinc	H8997	0,020
500	PH2	4,2 x 38	Zinc	H8998	0,025
1.000	PH2	4,8 x 13	Zinc	H8999	0,016
1.000	PH2	4,8 x 16	Zinc	H9000	0,018
1.000	PH2	4,8 x 19	Zinc	H9040	0,019
500	PH2	4,8 x 22	Zinc	H9041	0,023
500	PH2	4,8 x 25	Zinc	H9042	0,021
500	PH2	4,8 x 32	Zinc	H9043	0,028
500	PH2	4,8 x 38	Zinc	H9044	0,033
500	PH2	4,8 x 45	Zinc	H9045	0,040
500	PH2	4,8 x 50	Zinc	H9046	0,041
500	PH2	4,8 x 60	Zinc	H9047	0,084
250	PH2	4,8 x 70	Zinc	H9048	0,068
250	PH2	4,8 x 80	Zinc	H9049	0,080
500	PH2	5,5 x 19	Zinc	H9050	0,027
500	PH2	5,5 x 25	Zinc	H9051	0,030
500	PH2	5,5 x 32	Zinc	H9052	0,038
500	PH2	5,5 x 38	Zinc	H9053	0,043
500	PH2	5,5 x 50	Zinc	H9054	0,055
250	PH2	5,5 x 60	Zinc	H9055	0,070
250	PH2	5,5 x 70	Zinc	H9056	0,084
250	PH2	5,5 x 80	Zinc	H9057	0,102



Tornillo DIN 7981 r. chapa zincado

	TIPO			REF.	€
1.000	PH	2,9 x 6,5	Zinc	T9000	0,006
1.000	PH	2,9 x 9,5	Zinc	T9001	0,007
1.000	PH	2,9 x 13	Zinc	T9002	0,008
1.000	PH	2,9 x 16	Zinc	T9003	0,009
1.000	PH	2,9 x 19	Zinc	T9004	0,010
1.000	PH	2,9 x 22	Zinc	T9005	0,010
500	PH	2,9 x 25	Zinc	T9006	0,011
1.000	PH	3,5 x 6,5	Zinc	T9007	0,008
1.000	PH	3,5 x 9,5	Zinc	T9008	0,008
500	PH	3,5 x 13	Zinc	T9009	0,011
500	PH	3,5 x 16	Zinc	T9010	0,012
500	PH	3,5 x 19	Zinc	T9011	0,012
250	PH	3,5 x 25	Zinc	T9012	0,016
250	PH	3,5 x 32	Zinc	T9013	0,019
500	PH	3,9 x 9,5	Zinc	T9014	0,010
500	PH	3,9 x 13	Zinc	T9015	0,004
500	PH	3,9 x 16	Zinc	T9016	0,004
500	PH	3,9 x 19	Zinc	T9017	0,014
250	PH	3,9 x 22	Zinc	T9018	0,015
250	PH	3,9 x 25	Zinc	T9019	0,017
250	PH	3,9 x 32	Zinc	T9020	0,020
250	PH	3,9 x 38	Zinc	T9021	0,022
250	PH	3,9 x 45	Zinc	T9022	0,029
250	PH	3,9 x 50	Zinc	T9023	0,032
500	PH	4,2 x 9,5	Zinc	T9024	0,012
500	PH	4,2 x 13	Zinc	T9025	0,012
500	PH	4,2 x 16	Zinc	T9026	0,012
500	PH	4,2 x 19	Zinc	T9027	0,014
250	PH	4,2 x 22	Zinc	T9028	0,018
250	PH	4,2 x 25	Zinc	T9030	0,019
250	PH	4,2 x 32	Zinc	T9031	0,021
250	PH	4,2 x 38	Zinc	T9032	0,025
250	PH	4,2 x 45	Zinc	T9033	0,028
250	PH	4,2 x 50	Zinc	T9034	0,029
250	PH	4,2 x 60	Zinc	T9035	0,063
250	PH	4,2 x 70	Zinc	T9036	0,050
250	PH	4,2 x 80	Zinc	T9037	0,059
250	PH	4,2 x 90	Zinc	T9038	0,073
500	PH	4,8 x 9,5	Zinc	T9039	0,017
500	PH	4,8 x 13	Zinc	T9040	0,017
250	PH	4,8 x 16	Zinc	T9041	0,024
250	PH	4,8 x 19	Zinc	T9042	0,025
250	PH	4,8 x 22	Zinc	T9043	0,024
250	PH	4,8 x 25	Zinc	T9044	0,038
250	PH	4,8 x 32	Zinc	T9045	0,030
250	PH	4,8 x 38	Zinc	T9046	0,034
250	PH	4,8 x 45	Zinc	T9047	0,052
250	PH	4,8 x 50	Zinc	T9048	0,039
250	PH	4,8 x 60	Zinc	T9049	0,067
100	PH	4,8 x 70	Zinc	T9050	0,088
100	PH	4,8 x 80	Zinc	T9051	0,115
100	PH	4,8 x 90	Zinc	T9052	0,097
100	PH	4,8 x 100	Zinc	T9053	0,132
100	PH	4,8 x 110	Zinc	T9054	0,124
100	PH	4,8 x 120	Zinc	T9055	0,215
250	PH	5,5 x 13	Zinc	T9056	0,025

	TIPO			REF.	€
250	PH	5,5 x 16	Zinc	T9057	0,026
250	PH	5,5 x 19	Zinc	T9058	0,034
250	PH	5,5 x 22	Zinc	T9059	0,034
250	PH	5,5 x 25	Zinc	T9060	0,035
250	PH	5,5 x 32	Zinc	T9061	0,040
250	PH	5,5 x 38	Zinc	T9062	0,046
250	PH	5,5 x 45	Zinc	T9063	0,052
250	PH	5,5 x 50	Zinc	T9064	0,057
100	PH	5,5 x 60	Zinc	T9065	0,068
100	PH	5,5 x 70	Zinc	T9066	0,078
100	PH	5,5 x 80	Zinc	T9067	0,095
100	PH	5,5 x 90	Zinc	T9068	0,109
100	PH	5,5 x 100	Zinc	T9069	0,134
100	PH	5,5 x 110	Zinc	T9070	0,157
100	PH	5,5 x 120	Zinc	T9071	0,171
250	PH	6,3 x 16	Zinc	T9072	0,036
250	PH	6,3 x 19	Zinc	T9073	0,040
250	PH	6,3 x 22	Zinc	T9074	0,043
250	PH	6,3 x 25	Zinc	T9075	0,045
250	PH	6,3 x 32	Zinc	T9076	0,056
250	PH	6,3 x 38	Zinc	T9077	0,068
250	PH	6,3 x 45	Zinc	T9078	0,069
250	PH	6,3 x 50	Zinc	T9079	0,082
100	PH	6,3 x 60	Zinc	T9080	0,095
100	PH	6,3 x 70	Zinc	T9081	0,109
100	PH	6,3 x 80	Zinc	T9082	0,132
50	PH	6,3 x 90	Zinc	T9083	0,161
50	PH	6,3 x 100	Zinc	T9084	0,180
50	PH	6,3 x 110	Zinc	T9085	0,203
50	PH	6,3 x 120	Zinc	T9086	0,218

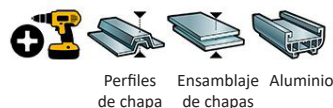
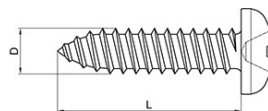
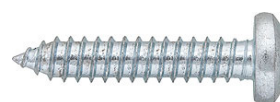

Tornillo DIN 7982 r. chapa zincado



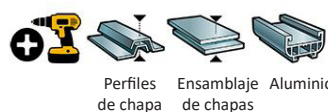
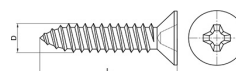
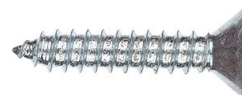

	TIPO			REF.	€
1.000	PH	2,9 x 6,5	Zinc	T9500	0,007
1.000	PH	2,9 x 9,5	Zinc	T9501	0,007
1.000	PH	2,9 x 13	Zinc	T9502	0,007
1.000	PH	2,9 x 16	Zinc	T9503	0,007
1.000	PH	2,9 x 19	Zinc	T9504	0,010
1.000	PH	2,9 x 22	Zinc	T9505	0,009
500	PH	2,9 x 25	Zinc	T9506	0,011
1.000	PH	3,5 x 9,5	Zinc	T9507	0,008
500	PH	3,5 x 13	Zinc	T9508	0,009
500	PH	3,5 x 16	Zinc	T9509	0,009
500	PH	3,5 x 19	Zinc	T9510	0,011
500	PH	3,5 x 22	Zinc	T9511	0,012
250	PH	3,5 x 25	Zinc	T9512	0,014
250	PH	3,5 x 32	Zinc	T9513	0,017
250	PH	3,5 x 38	Zinc	T9514	0,019
500	PH	3,9 x 9,5	Zinc	T9515	0,009
500	PH	3,9 x 13	Zinc	T9516	0,011
500	PH	3,9 x 16	Zinc	T9517	0,011
500	PH	3,9 x 19	Zinc	T9518	0,012
250	PH	3,9 x 22	Zinc	T9519	0,015
250	PH	3,9 x 25	Zinc	T9520	0,016
250	PH	3,9 x 32	Zinc	T9521	0,020
250	PH	3,9 x 38	Zinc	T9522	0,022
250	PH	3,9 x 45	Zinc	T9523	0,025
250	PH	3,9 x 50	Zinc	T9524	0,030
500	PH	4,2 x 13	Zinc	T9525	0,011
500	PH	4,2 x 16	Zinc	T9526	0,014
500	PH	4,2 x 19	Zinc	T9527	0,016
250	PH	4,2 x 22	Zinc	T9528	0,017
250	PH	4,2 x 25	Zinc	T9529	0,018
250	PH	4,2 x 32	Zinc	T9530	0,022
250	PH	4,2 x 38	Zinc	T9531	0,024
250	PH	4,2 x 45	Zinc	T9532	0,028
250	PH	4,2 x 50	Zinc	T9533	0,033
250	PH	4,2 x 60	Zinc	T9534	0,040
250	PH	4,2 x 70	Zinc	T9535	0,050
500	PH	4,8 x 13	Zinc	T9536	0,015
250	PH	4,8 x 16	Zinc	T9537	0,170
250	PH	4,8 x 19	Zinc	T9538	0,021
250	PH	4,8 x 22	Zinc	T9539	0,023
250	PH	4,8 x 25	Zinc	T9540	0,025
250	PH	4,8 x 32	Zinc	T9541	0,028
250	PH	4,8 x 38	Zinc	T9542	0,052
250	PH	4,8 x 45	Zinc	T9543	0,038
250	PH	4,8 x 50	Zinc	T9545	0,046
250	PH	4,8 x 60	Zinc	T9546	0,053
100	PH	4,8 x 70	Zinc	T9547	0,077

	TIPO			REF.	€
250	PH	5,5 x 13	Zinc	T9548	0,021
250	PH	5,5 x 16	Zinc	T9549	0,024
250	PH	5,5 x 19	Zinc	T9550	0,026
250	PH	5,5 x 22	Zinc	T9551	0,031
250	PH	5,5 x 25	Zinc	T9552	0,033
250	PH	5,5 x 32	Zinc	T9553	0,038
250	PH	5,5 x 38	Zinc	T9554	0,043
250	PH	5,5 x 45	Zinc	T9555	0,017
250	PH	5,5 x 50	Zinc	T9556	0,062
100	PH	5,5 x 60	Zinc	T9557	0,071
100	PH	5,5 x 70	Zinc	T9558	0,080
250	PH	6,3 x 25	Zinc	T9559	0,045
250	PH	6,3 x 32	Zinc	T9560	0,053
250	PH	6,3 x 38	Zinc	T9561	0,058
250	PH	6,3 x 45	Zinc	T9562	0,061
250	PH	6,3 x 50	Zinc	T9563	0,074
100	PH	6,3 x 60	Zinc	T9564	0,103
100	PH	6,3 x 70	Zinc	T9565	0,188
250	PH	4,2 x 25	Zinc Neg.	T9566	0,134



### Tornillo cierre punta broca PH2



**MAREFIX**  
FIXING SYSTEMS

	TIPO			REF.	€
500	PH2	4,2 x 14	Zincado	H8876	0,060
500	PH2	4,2 x 23	Zincado	H8877	0,071
500	PH2	4,2 x 14	Zinc. negro	H8878	0,066
500	PH2	4,2 x 23	Zinc. negro	H8879	0,105
500	PH2	4,2 x 14	Cab. Blanca	H8882	0,128
500	PH2	4,2 x 23	Cab. Blanca	H8883	0,141



### Tornillo p/cierre rosca HI-LO cabeza plana PH2

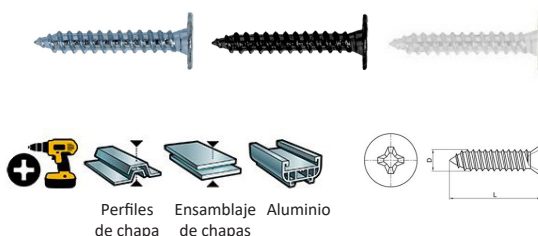

**MAREFIX**  
FIXING SYSTEMS

	TIPO			REF.	€
500	PH2	4,2 x 13	Zincado	H8884	0,032
500	PH2	4,2 x 22	Zincado	H8885	0,041
500	PH2	4,2 x 32	Zincado	H8886	0,055
500	PH2	4,2 x 13	Zinc. negro	H8887	0,047
500	PH2	4,2 x 22	Zinc. negro	H8888	0,059
500	PH2	4,2 x 32	Zinc. negro	H8889	0,081
500	PH2	4,2 x 13	Blanco	H8890	0,108
500	PH2	4,2 x 22	Blanco	H8891	0,120
500	PH2	4,2 x 32	Blanco	H8892	0,167



### Tornillo para PVC punta broca zincado

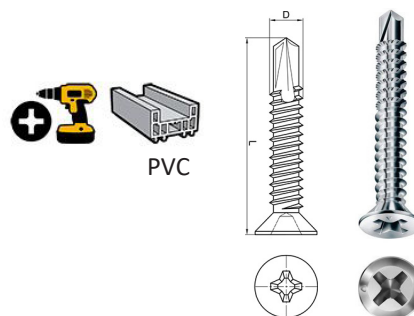

**SPAX**

	TIPO			REF.	€
1.000	PH	3,9 x 13	Zinc	T1100	0,076
1.000	PH	3,9 x 16	Zinc	T1101	0,080
1.000	PH	3,9 x 19	Zinc	T1102	0,084
1.000	PH	3,9 x 25	Zinc	T1103	0,091
1.000	PH	3,9 x 32	Zinc	T1104	0,106
1.000	PH	3,9 x 38	Zinc	T1105	0,124



### Tornillo para PVC rosca HI-LO zincado

**SPAX**

	TIPO			REF.	€
1.000	PH	4,0 x 16	Zinc	T1000	0,028
1.000	PH	4,0 x 20	Zinc	T1001	0,033
1.000	PH	4,0 x 22	Zinc	T1002	0,033
1.000	PH	4,0 x 25	Zinc	T1003	0,069
1.000	PH	4,0 x 30	Zinc	T1004	0,076
1.000	PH	4,0 x 35	Zinc	T1005	0,084
1.000	PH	4,0 x 40	Zinc	T1006	0,090
1.000	PH	4,0 x 45	Zinc	T1007	0,082
1.000	PH	4,0 x 50	Zinc	T1008	0,082
1.000	PH	4,0 x 55	Zinc	T1009	0,094

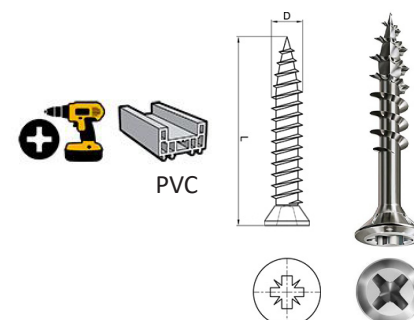









## Tornillo tirafondo PZ

Ideal para tacos de nylon o madera

**MAREFIX**  
FIXING SYSTEMS

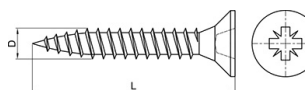

	TIPO			REF.	€
1.000	PZ	2,5 x 10	Bricomatado	T9600	0,015
1.000	PZ	2,5 x 12	Bricomatado	T9601	0,015
1.000	PZ	2,5 x 16	Bricomatado	T9602	0,017
1.000	PZ	2,5 x 20	Bricomatado	T9604	0,019
1.000	PZ	2,5 x 25	Bricomatado	T9605	0,020
1.000	PZ	3,0 x 12	Bricomatado	T9606	0,013
1.000	PZ	3,0 x 16	Bricomatado	T9607	0,014
1.000	PZ	3,0 x 20	Bricomatado	T9608	0,017
1.000	PZ	3,0 x 25	Bricomatado	T9609	0,019
1.000	PZ	3,0 x 30	Bricomatado	T9610	0,021
1.000	PZ	3,0 x 40	Bricomatado	T9611	0,028
1.000	PZ	3,5 x 16	Bricomatado	T9612	0,016
1.000	PZ	3,5 x 20	Bricomatado	T9613	0,020
1.000	PZ	3,5 x 25	Bricomatado	T9614	0,022
1.000	PZ	3,5 x 30	Bricomatado	T9615	0,025
500	PZ	3,5 x 35	Bricomatado	T9616	0,029
500	PZ	3,5 x 40	Bricomatado	T9617	0,034
250	PZ	3,5 x 50	Bricomatado	T9618	0,043
1.000	PZ	4,0 x 16	Bricomatado	T9619	0,021
1.000	PZ	4,0 x 20	Bricomatado	T9620	0,025
1.000	PZ	4,0 x 25	Bricomatado	T9621	0,027
500	PZ	4,0 x 30	Bricomatado	T9622	0,027
500	PZ	4,0 x 35	Bricomatado	T9623	0,038
500	PZ	4,0 x 40	Bricomatado	T9624	0,039
500	PZ	4,0 x 45	Bricomatado	T9625	0,047
250	PZ	4,0 x 50	Bricomatado	T9626	0,054
250	PZ	4,0 x 60	Bricomatado	T9627	0,058
250	PZ	4,0 x 70	Bricomatado	T9628	0,075
500	PZ	4,5 x 20	Bricomatado	T9629	0,030
500	PZ	4,5 x 25	Bricomatado	T9630	0,036
500	PZ	4,5 x 30	Bricomatado	T9631	0,042
500	PZ	4,5 x 35	Bricomatado	T9632	0,046
500	PZ	4,5 x 40	Bricomatado	T9633	0,052
250	PZ	4,5 x 45	Bricomatado	T9634	0,062
250	PZ	4,5 x 50	Bricomatado	T9635	0,067
250	PZ	4,5 x 60	Bricomatado	T9336	0,079
250	PZ	4,5 x 70	Bricomatado	T9637	0,099
100	PZ	4,5 x 80	Bricomatado	T9638	0,099
500	PZ	5,0 x 20	Bricomatado	T9639	0,038
500	PZ	5,0 x 25	Bricomatado	T9640	0,044
250	PZ	5,0 x 30	Bricomatado	T9641	0,052
250	PZ	5,0 x 35	Bricomatado	T9642	0,061
250	PZ	5,0 x 40	Bricomatado	T9643	0,068
250	PZ	5,0 x 45	Bricomatado	T9644	0,076
250	PZ	5,0 x 50	Bricomatado	T9645	0,079
250	PZ	5,0 x 60	Bricomatado	T9646	0,094
100	PZ	5,0 x 70	Bricomatado	T9647	0,119
100	PZ	5,0 x 80	Bricomatado	T9648	0,132
100	PZ	5,0 x 90	Bricomatado	T9649	0,161
100	PZ	5,0 x 100	Bricomatado	T9650	0,169
100	PZ	5,0 x 120	Bricomatado	T9651	0,169
250	PZ	6,0 x 40	Bricomatado	T9652	0,094
250	PZ	6,0 x 50	Bricomatado	T9653	0,112
250	PZ	6,0 x 60	Bricomatado	T9654	0,128
100	PZ	6,0 x 70	Bricomatado	T9655	0,178
100	PZ	6,0 x 80	Bricomatado	T9656	0,192

	TIPO			REF.	€
100	PZ	6,0 x 90	Bricomatado	T9657	0,222
100	PZ	6,0 x 100	Bricomatado	T9658	0,250
100	PZ	6,0 x 110	Bricomatado	T9659	0,287
100	PZ	6,0 x 120	Bricomatado	T9660	0,311
100	PZ	6,0 x 130	Bricomatado	T9661	0,359
100	PZ	6,0 x 140	Bricomatado	T9662	0,399
100	PZ	6,0 x 150	Bricomatado	T9663	0,446
100	PZ	6,0 x 160	Bricomatado	T9664	0,468
100	PZ	6,0 x 180	Bricomatado	T9665	0,710
100	PZ	6,0 x 200	Bricomatado	T9666	0,925
100	PZ	6,0 x 220	Bricomatado	T9667	1,426



### Tacos clavable cabeza avellanada



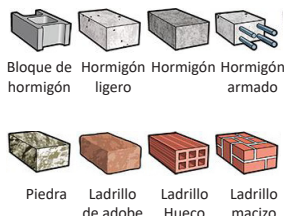

		REF.	€
100	5 x 25	H7950	0,041
100	5 x 30	H7951	0,041
100	5 x 35	H7952	0,051
100	5 x 50	H7953	0,059
100	6 x 35	H7954	0,055
100	6 x 40	H7955	0,055
100	6 x 50	H7956	0,070
100	6 x 60	H7957	0,076
100	6 x 70	H7958	0,089
100	6 x 80	H7959	0,109
100	8 x 60	H7960	0,120
100	8 x 80	H7961	0,146
100	8 x 100	H7962	0,173
100	8 x 120	H7963	0,212
100	8 x 140	H7964	0,239



### Tacos clavable cabeza cilíndrica





		REF.	€
100	5 x 25	H7965	0,041
100	5 x 30	H7966	0,041
100	5 x 35	H7967	0,051
100	5 x 50	H7968	0,058
100	6 x 35	H7969	0,056
100	6 x 40	H7970	0,055
100	6 x 50	H7971	0,069
100	6 x 60	H7972	0,077
100	6 x 70	H7973	0,089
100	8 x 60	H7974	0,121
100	8 x 80	H7975	0,147
100	8 x 100	H7976	0,173
100	8 x 120	H7977	0,208
100	8 x 140	H7978	0,238



### Tacos para pladur

Tipo rosca, de nylon

		REF.	€
100	15 x 33	H8700	2,125





Panel de pladur





### Tacos de nylon con collarín



Resistente a temperaturas entre -50°C y +75°C

		REF.	€
200	5 x 25	H8803	0,030
100	6 x 30	H8804	0,062
100	8 x 40	H8805	0,111
50	10 x 50	H8806	0,427



### Tacos de nylon sin collarín

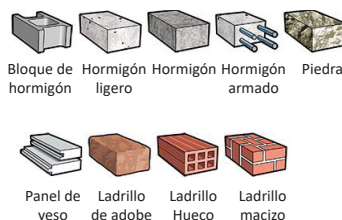

Resistente a temperaturas entre -50°C y +75°C

		REF.	€
200	5 x 25	H8797	0,030
100	6 x 30	H8798	0,062
100	8 x 40	H8799	0,111
50	10 x 50	H8800	0,428
25	12 x 60	H8801	1,440
20	14 x 80	H8802	3,044



### Tacos de nylon nudo

Abertura lateral para mayor expansión, resistente a temperaturas entre -40°C y +80°C



		REF.	€
100	5 x 25	H8791	0,093
100	6 x 30	H8792	0,099
100	8 x 40	H8793	0,182
50	10 x 50	H8794	0,622
25	12 x 60	H8795	2,230
20	14 x 80	H8796	3,194



### Tacos Duopower

Soporta un 25% mas de carga, adecuado para cavidades reducidas



		REF.	€
100	5 x 25	H8750	0,099
100	6 x 30	H8751	0,132
100	8 x 40	H8752	0,200
50	10 x 50	H8753	0,390
25	12 x 60	H8754	0,650



Vídeo demostración



### Anclaje argolla de expansión para cargas medias

Argolla cerrada, utilización en soportes macizos



		$\varnothing$		REF.	€
100	6 x 45	8	Media	H8818	0,967
100	8 x 60	10	Media	H8819	1,695
50	10 x 70	12	Media	H8820	2,750
50	10 x 70	14	Media	H8821	3,131
25	12 x 80	16	Media	H8822	4,877



### Anclaje gancho de expansión para cargas medias

Gancho abierto, utilización en soportes macizos



		$\varnothing$		REF.	€
100	6 x 45	8	Media	H8823	0,966
100	8 x 60	10	Media	H8824	1,695
50	10 x 70	12	Media	H8825	2,750
50	10 x 70	14	Media	H8826	3,131
25	12 x 80	16	Media	H8827	4,870

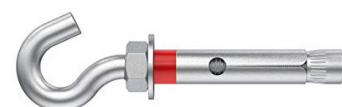

### Anclaje de expansión para cargas medias

Tornillo hexagonal, utilización en soportes macizos



		$\varnothing$		REF.	€
200	6 x 45	8	Media	H8807	0,156
100	6 x 60	8	Media	H8808	0,700
100	8 x 60	10	Media	H8809	0,273
100	8 x 80	10	Media	H8810	0,316
200	10 x 70	12	Media	H8811	0,470
50	10 x 100	12	Media	H8812	0,564
100	10 x 70	14	Media	H8813	0,556
50	10 x 100	14	Media	H8814	0,697
50	12 x 80	16	Media	H8815	0,808
50	12 x 110	16	Media	H8816	0,980
50	16 x 110	20	Media	H8817	1,903



### Anclaje de expansión inox A2 para cargas medias

Tornillo hexagonal, utilización en soportes macizos, alta resistencia a la humedad y la oxidación



		$\varnothing$		REF.	€
200	6 x 45	8	Media	H8828	2,327
200	6 x 60	8	Media	H8829	2,705
100	8 x 60	10	Media	H8830	4,038
100	8 x 80	10	Media	H8831	4,810
100	10 x 70	12	Media	H8832	6,798
50	10 x 100	12	Media	H8833	8,391
100	10 x 70	14	Media	H8834	8,688
50	10 x 100	14	Media	H8835	10,192
50	12 x 80	16	Media	H8836	12,227
50	12 x 110	16	Media	H8837	17,163
25	16 x 110	20	Media	H8838	28,402











**966965002**

