

ZENIT VIEW

Häusen[®]
Accesorios para puertas y ventanas

V.4.

ZENIT



INDICE

TÍTULO	PÁGINA
EJEMPLO HOJA ACTIVA	4
EJEMPLO DOBLE HOJA	6
KITS ZENIT VIEW	8
MANILLAS	9
ACCESORIOS	13
COMPÁS RETENEDOR "RAPTOR"	18
CERRADURA BLOQUEO VENTANA "SEAL"	18

HOJA ACTIVA

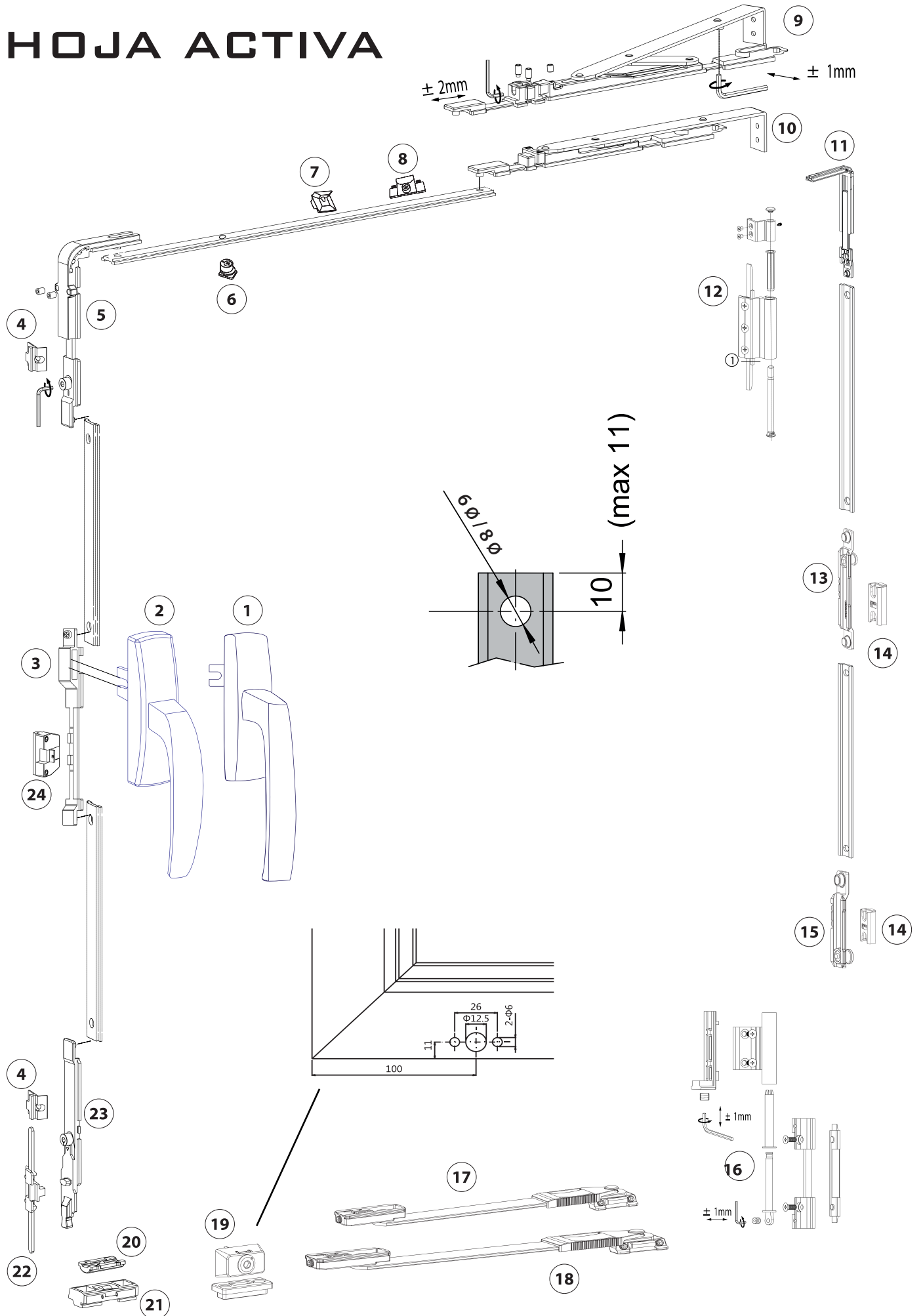

HOJA ACTIVA

NUMERO	REF.	DESCRIPCIÓN
1	Z0053	Manilla Yak con pala "U"
2	H1107	Manilla Cosmo con pala "U"
3	H1100	Conexión cremona Manilla Yak / Cosmo
4	H1100	Cerradero aluminio angulo reenvio
5	H1100	Ángulo reenvio O. B.
6	Z0059	Punto de cierre atornillable regulable
7	P1744	Cerradero aluminio marco C.E. 10 mm.
8	P1695	Cerradero ajustable C.E.
9	H1106	Compas Oscilo Batiente 530-1600 mm
10	H1105	Compas Oscilo Batiente 370-530 mm
11	H1108	Ángulo reenvio trasero
12	H1102	Bisagra hoja activa superior
13	Z0039	Punto cierre regulable intermedio de seguridad
14	Z0036	Cerradero punto cierre seguridad
15	Z0040	Punto cierre regulable final de seguridad
16	H1102	Bisagra hoja activa inferior
17	Z0019	Compás retenedor corto
18	Z0020	Compás retenedor largo
19	Z0028	Cerradura bloqueo de ventanas
20	H1100	Resbalón apoyo hoja
21	H1100	Cerradero de plastico inferior
22	H1100	Cerradero lateral puntero simple hoja
23	H1100	Pasador inferior
24	H1100	Falsa maniobra
	H1100	Kit base O.B. simple hoja (3, 4, 5, 20, 21, 22, 23, 24)

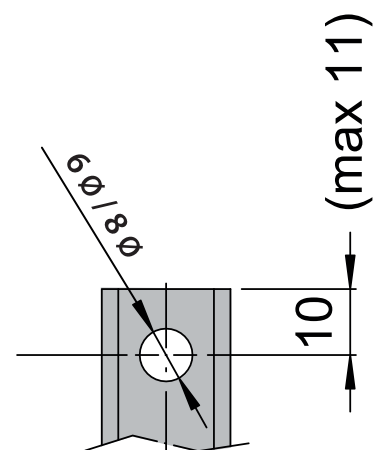
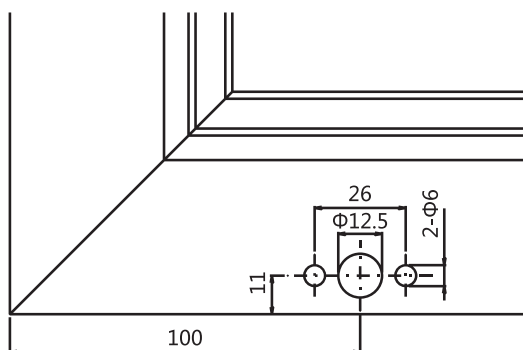

HOJA PASIVA

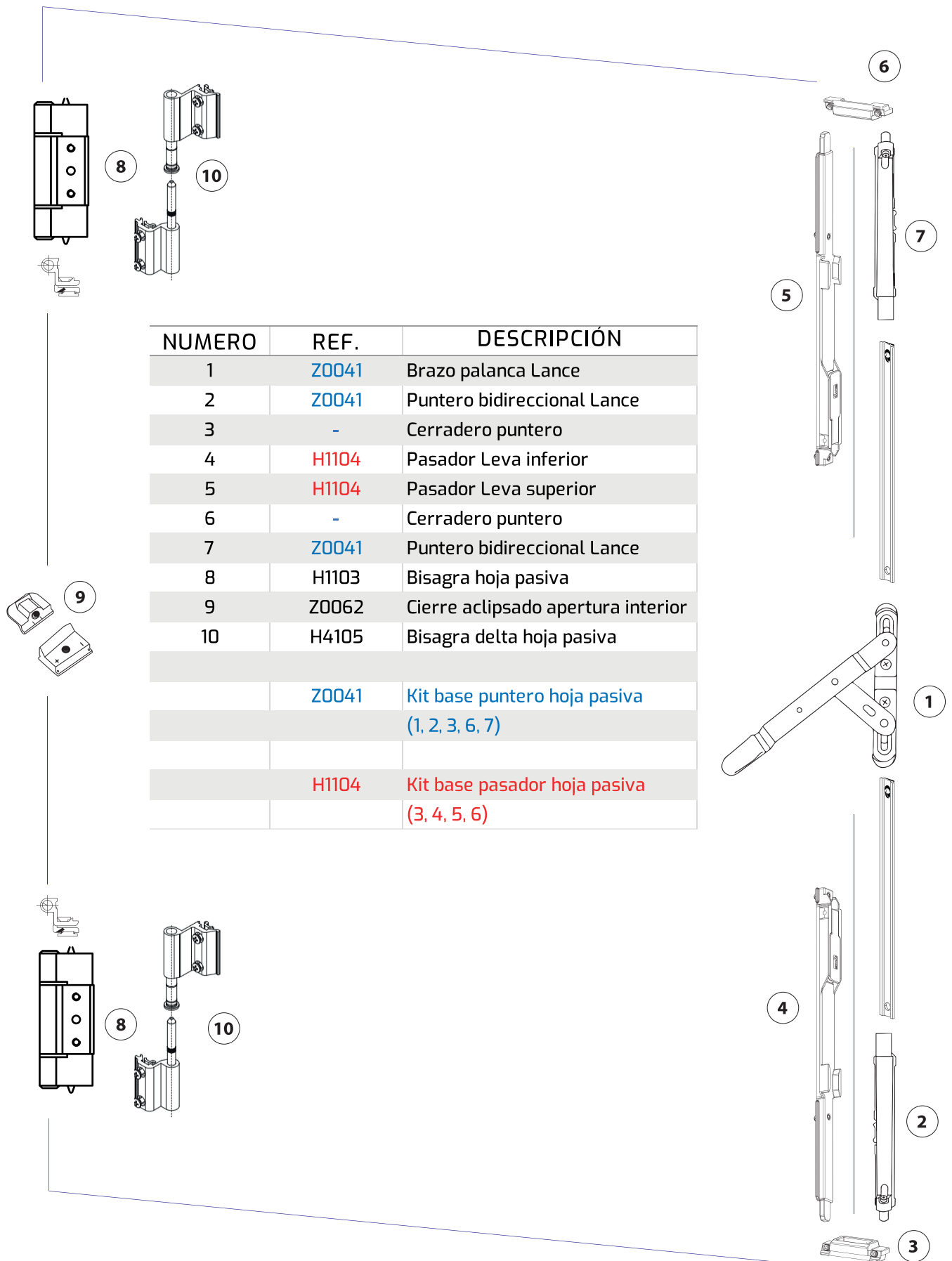

HOJA ACTIVA

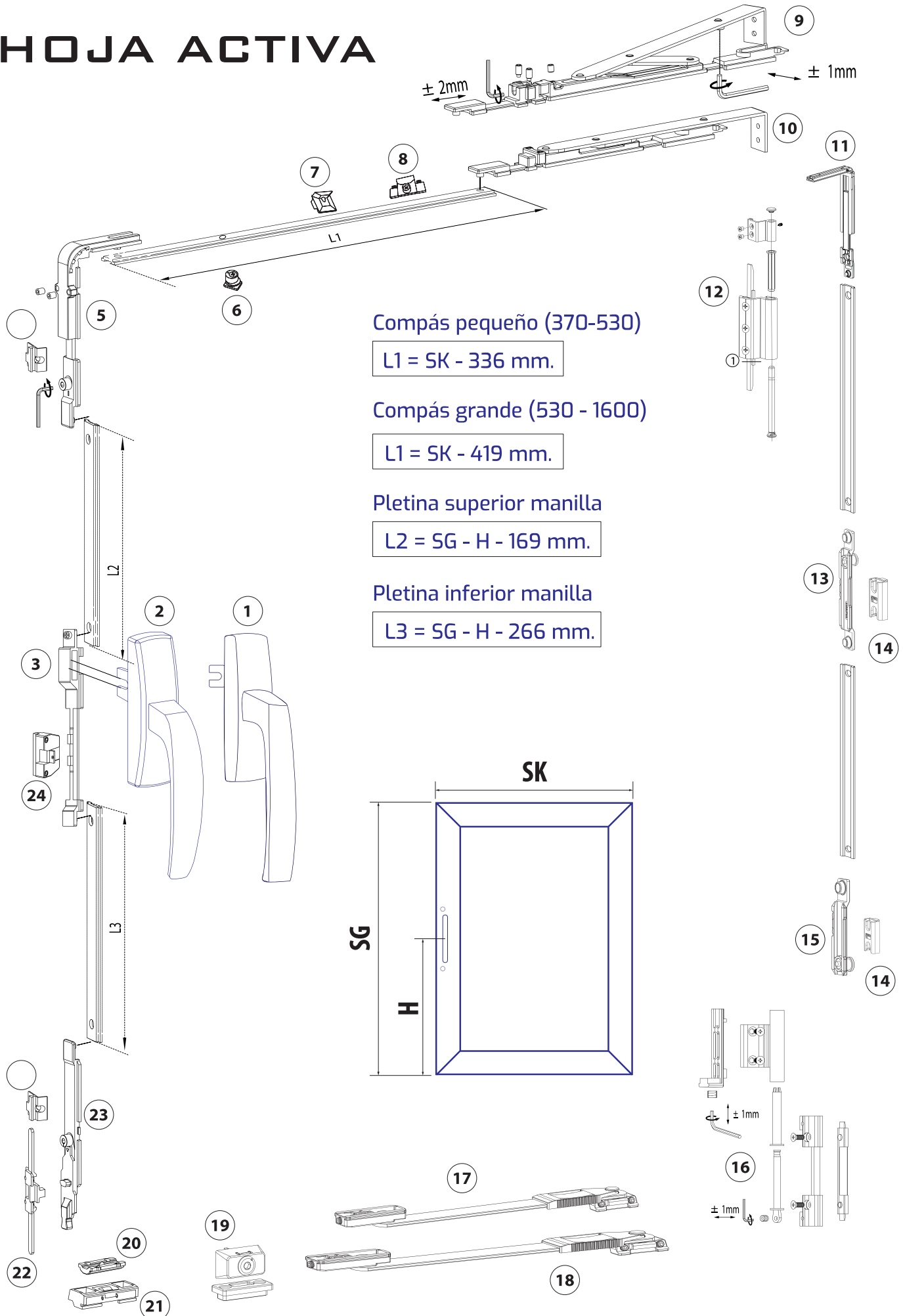

KITS ZENIT VIEW

Zenit view kit base oscilo batiente simple hoja

	DESCRIPCIÓN	REF:
10	Kit base oscilo batiente simple hoja	H1100

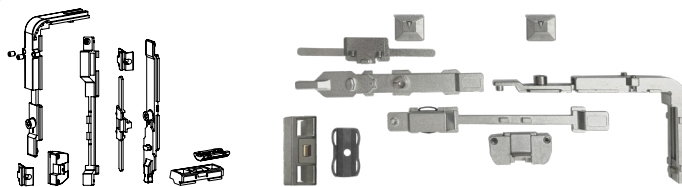

Zenit view kit base oscilo batiente doble hoja

	DESCRIPCIÓN	REF.
10	Kit base oscilo batiente doble hoja	H1101

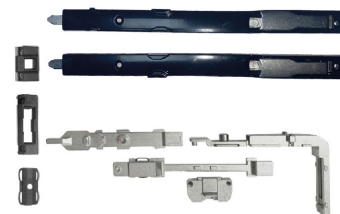
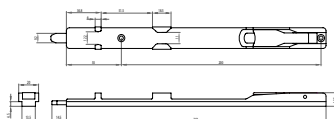

Zenit view kit pasadores oscilo batiente Leva

	DESCRIPCIÓN	REF.
10	Kit pasadores Leva	H1104

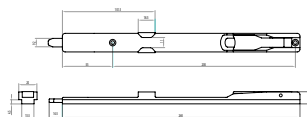

Kit pasadores palanca bidireccionales Lance

	DESCRIPCIÓN	REF:
20	Kit pasadores palanca bidireccionales Lance	Z0041

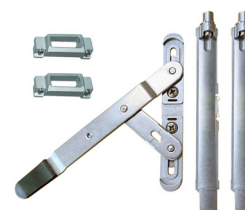
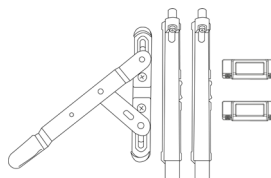

Zenit view compás oscilo batiente 370 - 530 mm

	DESCRIPCIÓN	REF.
10	Compás oscilo batiente 370 - 530 mm	H1105

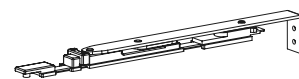

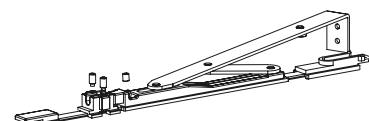

Zenit view compás oscilo batiente 530 - 1600 mm

	DESCRIPCIÓN	REF.
10	Compás oscilo batiente 530 - 1600 mm	H1106





Zenit view kit bisagras hoja activa

			DESCRIPCIÓN	REF.
10			Kit bisagras hoja activa blanco	H1102-9016
10			Kit bisagras hoja activa negro	H1102-9005



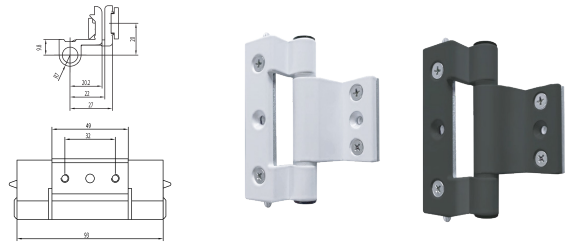

Zenit view bisagras hoja pasiva

			DESCRIPCIÓN	REF.
20			Bisagras hoja pasiva blanco	H1103-9016
20			Bisagras hoja pasiva negro	H1103-9005





Zenit view bisagra Delta hoja pasiva

			DESCRIPCIÓN	REF.
10			Bisagra hoja pasiva derecha blanco	H4105D-9016
10			Bisagra hoja pasiva derecha blanco	H4105I-9016
10			Bisagra hoja pasiva izquierda negro	H4105D-9005
10			Bisagra hoja pasiva izquierda negro	H4105I-9005





MANILLAS ZENIT VIEW

Manilla Cosmo con pala "U"

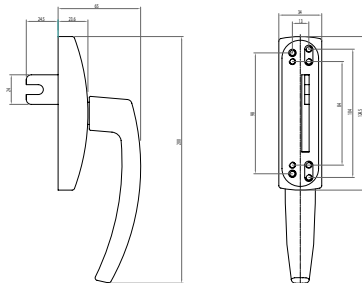
			DESCRIPCIÓN	REF.
10			Cremona cosmo pala "U" blanco	H1107
10			Cremona cosmo pala "U" negro	H1107



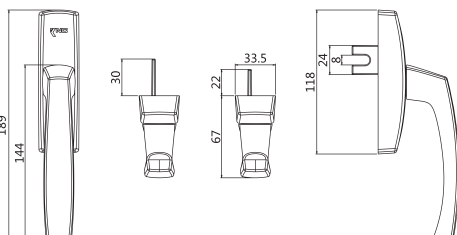

Manilla Yak con pala de "U"

		DESCRIPCIÓN		REF:
25		Cremona Yak blanca pala U	9016	Z0053-9016
25		Cremona Yak negra pala U	9005	Z0053-9005
25		Cremona Yak plata pala U	9006	Z0053-9006



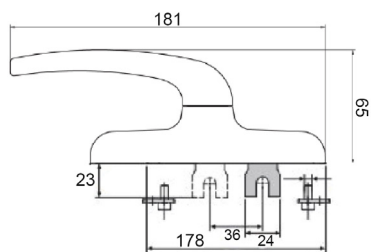

Manilla Atenea con pala de "U"

	DESCRIPCIÓN		REF:
25	Cremona Atenea blanca	9016	H6051-9016
25	Cremona Atenea negra	9005	H6051-9005



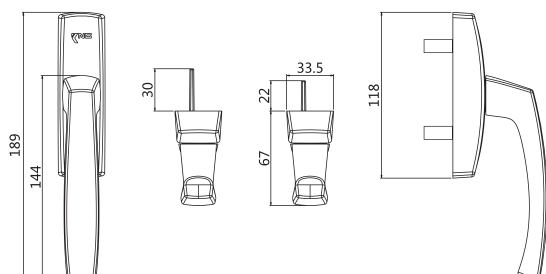

Manilla Yak con 2 palas

	DESCRIPCIÓN		REF:
25	Cremona Yak blanca 2 palas	9016	Z0056-9016
25	Cremona Yak negra 2 palas	9005	Z0056-9005
25	Cremona Yak plata 2 palas	9006	Z0056-9006



Manilla Atenea con 2 palas

	DESCRIPCIÓN		REF:
25	Cremona Atenea blanca 2 palas	9016	H6050-9016
25	Cremona Atenea negro 2 palas	9005	H6050-9005

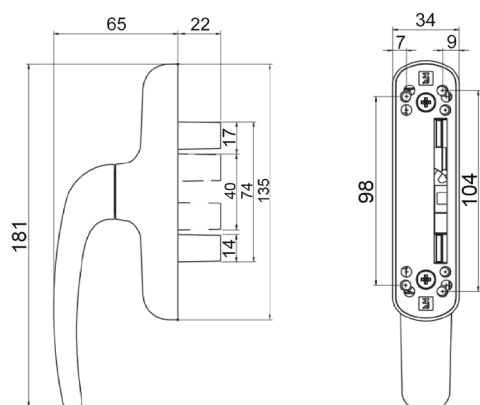

Kit cerraderos 1 hoja microventilación

	DESCRIPCIÓN	REF:
10	Kit cerraderos C.E. 1 hoja microventilacion	H7021

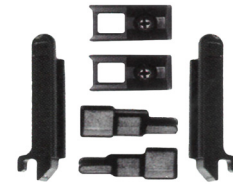

Kit cerraderos 2 hojas microventilación

	DESCRIPCIÓN	REF:
10	Kit cerraderos C.E. 2 hojas microventilacion	H7022



Kit cerraderos 1 hoja canal europeo

	DESCRIPCIÓN	REF:
10	Kit cerraderos Canal Europeo 1 hoja	J6001



Kit cerraderos 2 hojas canal europeo

	DESCRIPCIÓN	REF:
10	Kit cerraderos Canal Europeo 2 hojas	J6003

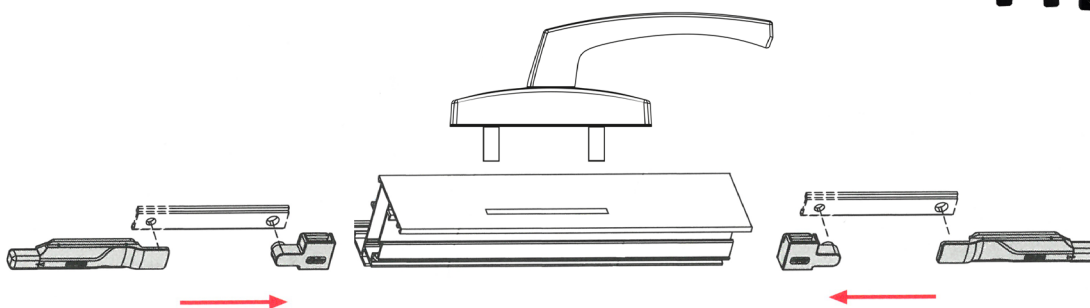

Manilla Corvaire con escudo

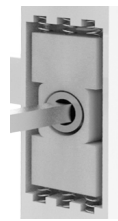

		INTEREJE		REF.
40	2	92mm	9016	P2384-9016
40	2	92mm	9006	P2384-9006
40	2	92mm	9005	P2384-9005
40	2	92mm	8022	P2384-8022
20	2	85mm	9016	P2385-9016
20	2	85mm	9006	P2385-9006
20	2	85mm	9005	P2385-9005
20	2	85mm	8022	P2385-8022

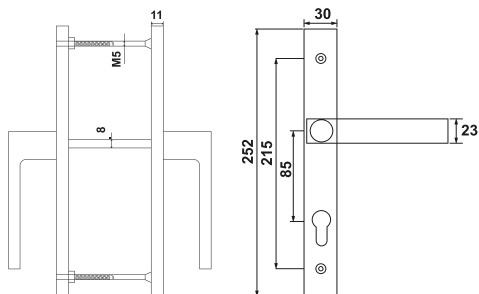

6 MUELLES DE PRESIÓN



Juego manilla Yak con escudo

	DESCRIPCIÓN		REF:
25	Cremona Yak escudo blanca	9016	Z0054-9016
25	Cremona Yak escudo negra	9005	Z0054-9005
25	Cremona Yak escudo plata	9006	Z0054-9006

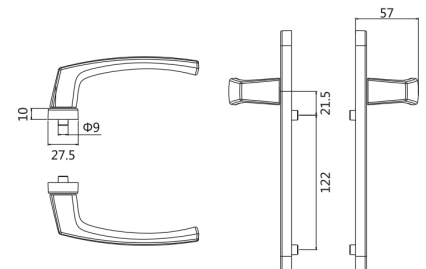
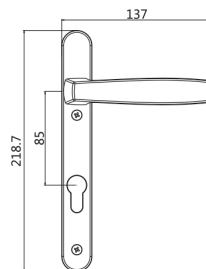

ACCESORIOS

Compás retenedor corto inox. SS304 - 10" / 25cm

Para hojas de tamaño hasta 445mm

	DESCRIPCIÓN		REF:
100	Compás retenedor 25cm	250 mm	Z0019

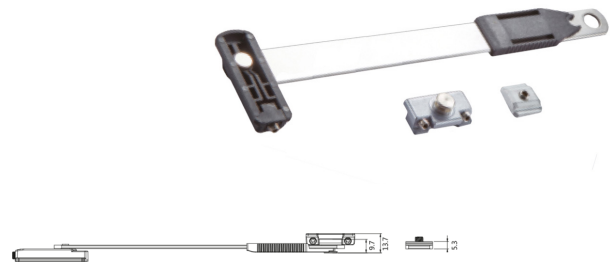
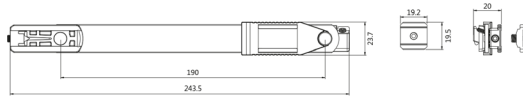

Compás retenedor corto inox. SS304 - 10" / 30cm

Para hojas de tamaño desde 445mm

	DESCRIPCIÓN		REF:
100	Compás retenedor 30cm	300 mm	Z0020

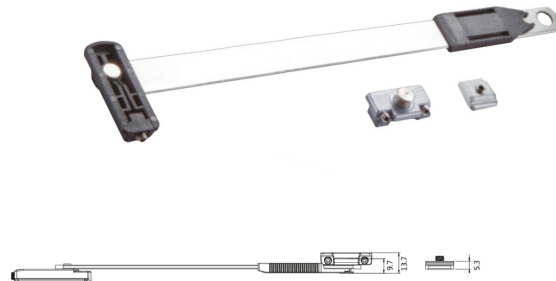
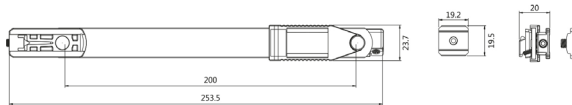

Cerradero pasadores leva 2ª hoja

	DESCRIPCIÓN	REF:
---	Cerradero pasadores leva 2ª hoja	Z0013

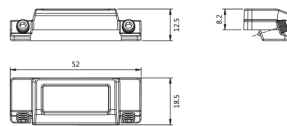

O.B. cerradero marco reenvío

	DESCRIPCIÓN	POSICIÓN	REF:
---	Cerradero aluminio marco C.E.	Lateral	P1744

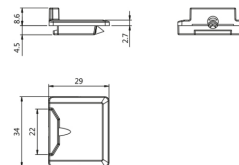

Cerradero bulón seguridad

	DESCRIPCIÓN	REF:
---	Cerradero para bulón seguridad	Z0036

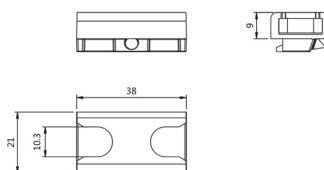

Cerradero ajustable C.E.

	DESCRIPCIÓN	REF:
25	Cerradero ajustable C.E.	P1695

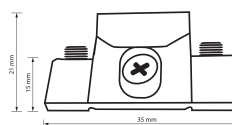

Ángulo reenvío C.E.

DESCRIPCIÓN	REF:
25 Ángulo reenvío C.E.	Z0023

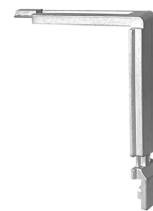
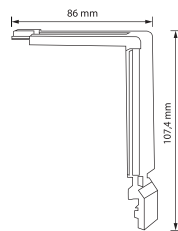

Kit reenvío + p/cierre final + cerradero C.E.

DESCRIPCIÓN	REF:
20 Kit reenvío + p/cierre final estandar + cerradero	ZK004
20 Kit reenvío + p/cierre final seguridad + cerradero	ZK024

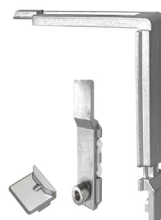

ZK004



ZK024

Kit reenvío + 2 puntos cierre + cerraderos

DESCRIPCIÓN	REF:
20 Kit reenvío + 2 p/cierre estandar + 2 cerraderos	ZK005
20 Kit reenvío + 2 p/cierre seguridad + 2 cerraderos	ZK025

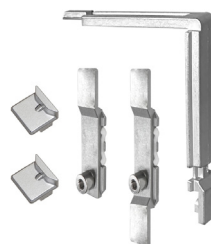

ZK005

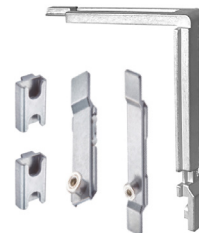

ZK025

Kit punto cierre final + cerradero **estándar**

DESCRIPCIÓN	REF:
50 Kit punto cierre final + cerradero	ZK002

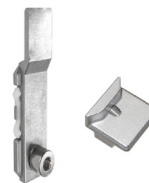
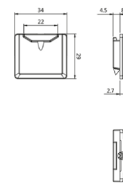
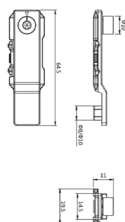

Kit punto cierre intermedio + cerradero **estándar**

DESCRIPCIÓN	REF:
50 Kit punto cierre intermedio + cerradero	ZK003

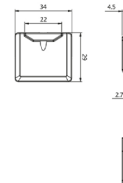
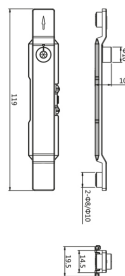

Kit punto cierre final + cerradero **seguridad**

DESCRIPCIÓN	REF:
50 Kit punto cierre final seg. + cerradero	ZK021

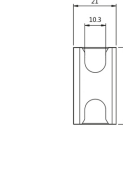
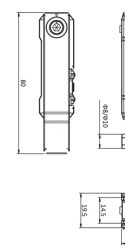

Kit punto cierre intermedio + cerradero seguridad



DESCRIPCIÓN

REF:

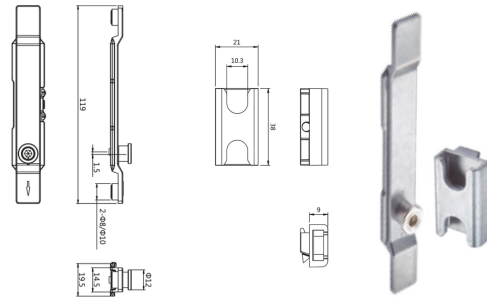
50 Kit punto cierre intermedio seg. + cerradero **ZK022**

Kit punto de cierre regulable pasante estándar



DESCRIPCIÓN

REF:

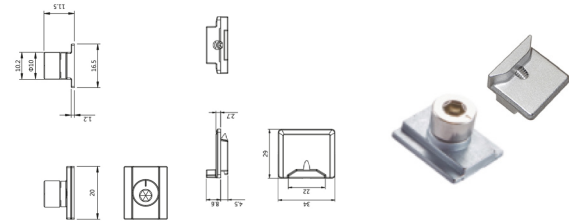
50 Kit punto cierre reg. pasante estándar **ZK038**

Kit punto de cierre regulable pasante seguridad



DESCRIPCIÓN

REF:

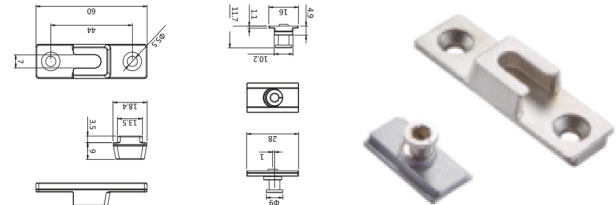
50 Kit punto cierre reg. pasante seg. **ZK037**

Cierre acoplado apertura interior



DESCRIPCIÓN

REF:

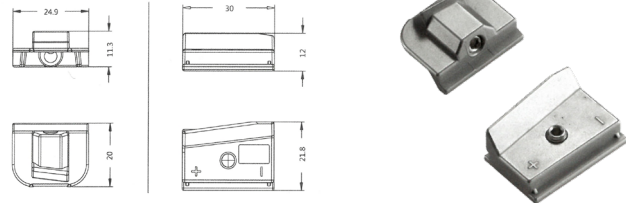
50 Cierre acoplado apertura interior **Z0062**

Cierre acoplado apertura exterior



DESCRIPCIÓN

REF:

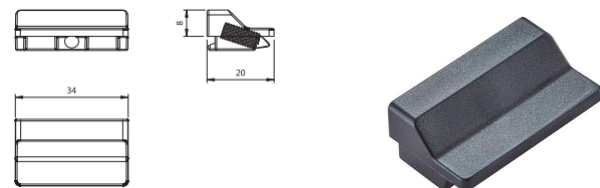
50 Cierre acoplado apertura exterior **Z0038**

Kit resbalón + apoyo hoja



DESCRIPCIÓN

REF:

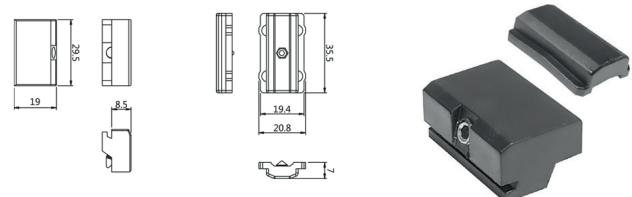
100 Resbalón + apoyo hoja **Z0010**

RAPTOR

COMPÁS RETENEDOR AUTOMÁTICO



SEAL

CERRADURA BLOQUEO DE VENTANAS



	DESCRIPCIÓN	REF:
20	Raptor compás limitador automático	Z0027

RAPTOR

RETENEDOR AUTOMÁTICO



Demostración



	DESCRIPCIÓN		REF:
20	Cerradura bloqueo de ventanas	Blanco	Z0028-9016
20	Cerradura bloqueo de ventanas	Negro	Z0028-9005

SEAL

CERRADURA BLOQUEO DE VENTANAS

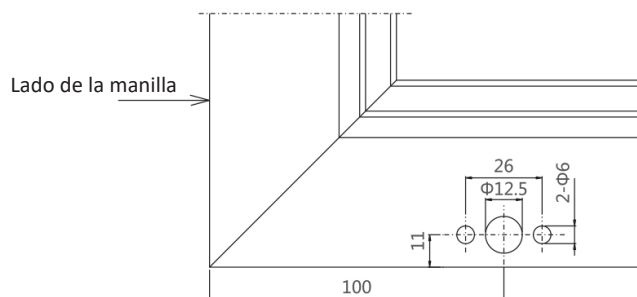

Mantenga a su familia segura

INFORME DE ENSAYO
HERRAJES PARA LA EDIFICACIÓN
HERRAJES OSCIOBATIENTES, BATIENTES,
OSCILANTES Y DE APERTURA BATIENTE
REQUISITOS Y MÉTODOS DE ENSAYO



PETICIONARIO <i>Applicant</i>	LEVANTINA DE ACCESORIOS, S.L. Pº El Castillo, c/ Alborg, 15-A 03630- Sax. Alicante
Herrajes	LEVANTINA DE ACCESORIOS, S.L.
PRODUCTO <i>Product</i>	HERRAJE O.B. para Cámara Europea
MODELO⁽¹⁾ <i>Reference</i>	O.B. ZENIT VIEW C.E.
FECHAS DE ENSAYO <i>Date/s of test</i>	20.11.2023
FECHA DE EMISIÓN <i>Date of issue</i>	04.12.2023

Normas de ensayo
 UNE-EN 13126-1:2022.
 Herrajes para la edificación.
 Herrajes para ventanas y
 puertas balconeras. Requisitos y
 métodos de ensayo. Parte 1:
 Requisitos comunes a todos los
 tipos de herrajes.
 UNE-EN 13126-8:2018.
 Herrajes para la edificación.
 Herrajes para ventanas y
 puertas balconeras. Parte 8:
 Requisitos y métodos de ensayo
 para herrajes oscilobatientes,
 batiente, oscilantes y de
 apertura batiente.

Secciones:

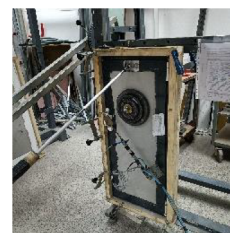

RESULTADOS

Results

	Durabilidad 20000 ciclos	Masa Peso hoja (kg)	Resistencia a la corrosión	Dimensiones de ensayo
EN 13129-8:2017	H3	080	5	630x1050

OBSERVACIONES: La resistencia a la corrosión se ha realizado hasta 1008 horas, sin detectar ninguna incidencia.

Luis García Viguera
 Director Técnico Departamento
Department Director

El resultado del presente ensayo/s no concierne más que al objeto/s ensayado/s. Los informes firmados electrónicamente en soporte digital se consideran un documento original, así como las copias electrónicas del mismo. Su impresión en papel no tiene validez legal

⁽¹⁾ ENSATEC, S.L.U., declina toda la responsabilidad sobre la información aportada por el cliente. Este informe anula y sustituye al documento 258614, con fecha de emisión 25.08.2023, por cambio de denominaciones del producto, productor y material a petición del cliente

PY23-0205 / Documento N° 259089

Häusen[®]
Accesorios para puertas y ventanas
966965002

