

camí

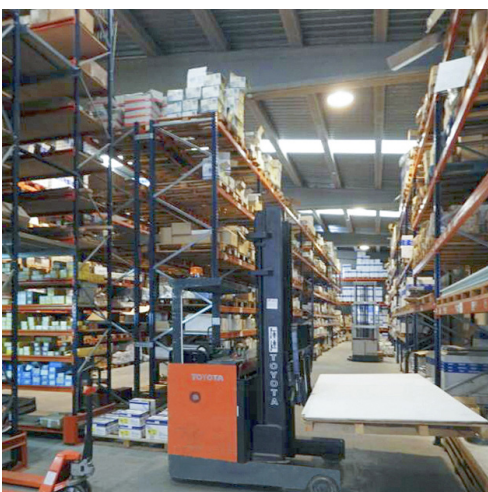

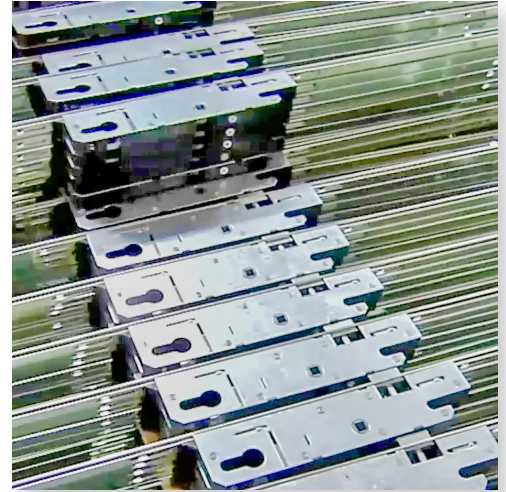

Vídeo
Presentación

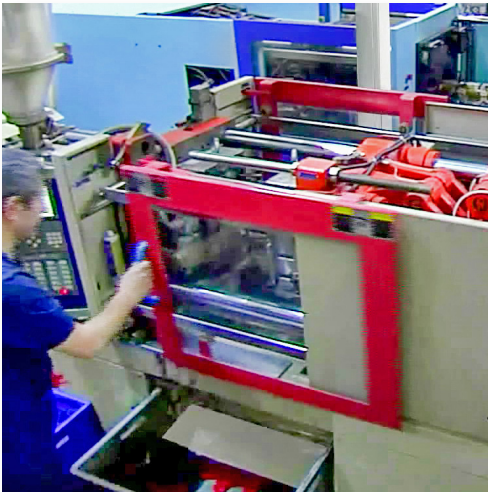
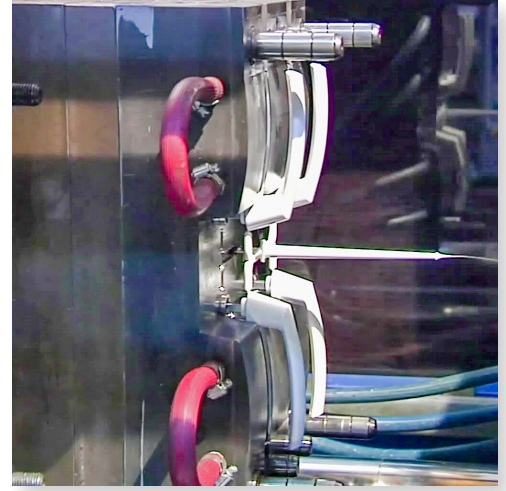

tecnalia Inspiring Business

www.tecnalia.com

Notificación de Ensayos y Clasificación

EMPRESA: HÄUSEN S.L.
DIRECCIÓN: P.I. EL CASTILLO, C/ AALBORG, 9 03630 SAX (ALICANTE)
Nº INFORME ASOCIADO: 075630

VENTANA DE PVC OSCILOBIANTE DOS HOJAS (1.200 x 1.500)mm
REF. «VENTANA OSCILOBIANTE DOBLE HOJA HAUSEN-ALPHACAN»

ENSAYO	RESULTADO
PERMEABILIDAD AL AIRE (UNE-EN 1026:2000)	CLASE 3
ESTANQUIDAD AL AGUA (UNE-EN 1027:2000)	CLASE E900
RESISTENCIA A LA CARGA DE VIENTO (UNE-EN 12211:2000)	CLASE C5

Fecha de ensayo: 25.07.2018
Fecha de emisión: 01.10.2018

Este resultado es el resumen de los datos indicados en el 'Informe de Ensayo' detallado en el apartado correspondiente.
Los resultados obtenidos en estos ensayos solo se refieren a la(s) muestra(s) analizada(s) en este Centro en la fecha indicada y no implican una característica de consistencia en la calidad de la producción.
Este certificado no podrá ser reproducido sin la autorización expresa de TECNALIA, excepto cuando se use de forma íntegra.

Foto: Ion Oñiza, Responsable Técnico

Área Análisis - C-20750 Apapita (España) - T: +34 965 430 850 (internacional calls)

tecnalia Inspiring Business

www.tecnalia.com

Notificación de Ensayo y Clasificación

EMPRESA: HÄUSEN S.L.
DIRECCIÓN: P.I. EL CASTILLO, C/ AALBORG, 9 03630 SAX (ALICANTE)
Nº CERTIFICADO: 13_03695-1

VENTANA DE PVC OSCILOBIANTE DOS HOJAS P. CIERRE STANDARD (1.560 x 1.220)mm
REF. «KOMMERLING - HÄUSEN»

ENSAYO	RESULTADO
PERMEABILIDAD AL AIRE (UNE-EN 1026:2000)	CLASE 4
ESTANQUIDAD AL AGUA (UNE-EN 1027:2000)	CLASE 7A
RESISTENCIA A LA CARGA DE VIENTO (UNE-EN 12211:2000)	CLASE C5

Fecha de emisión: 28 de Noviembre de 2013

Este resultado obtenido en estos ensayos solo se refiere a la(s) muestra(s) analizada(s) en este Centro en la fecha indicada y no implican una característica de consistencia en la calidad de la producción.
Este certificado no podrá ser reproducido sin la autorización expresa de TECNALIA, excepto cuando se use de forma íntegra.

Foto: Miguel Malvar, Responsable Técnico

Área Análisis - C-20750 Apapita (España) - T: +34 965 430 850 (internacional calls)

tecnalia Inspiring Business

www.tecnalia.com

Notificación de Ensayo y Clasificación

EMPRESA: HÄUSEN S.L.
DIRECCIÓN: P.I. EL CASTILLO, C/ AALBORG, 9 03630 SAX (ALICANTE)
Nº CERTIFICADO: 13_03699-1

VENTANA DE PVC OSCILOBIANTE DOS HOJAS P. CIERRE STANDARD (1.580 x 1.230)mm
REF. «ALUPLAST - HÄUSEN»

ENSAYO	RESULTADO
PERMEABILIDAD AL AIRE (UNE-EN 1026:2000)	CLASE 4
ESTANQUIDAD AL AGUA (UNE-EN 1027:2000)	CLASE 6A
RESISTENCIA A LA CARGA DE VIENTO (UNE-EN 12211:2000)	CLASE C5

Fecha de emisión: 28 de Noviembre de 2013

Los resultados obtenidos en estos ensayos solo se refieren a la(s) muestra(s) analizada(s) en este Centro en la fecha indicada y no implican una característica de consistencia en la calidad de la producción.
Este certificado no podrá ser reproducido sin la autorización expresa de TECNALIA, excepto cuando se use de forma íntegra.

Foto: Miguel Malvar, Responsable Técnico

Área Análisis - C-20750 Apapita (España) - T: +34 965 430 850 (internacional calls)

tecnalia Inspiring Business

www.tecnalia.com

Notificación de Ensayo y Clasificación

EMPRESA: HÄUSEN S.L.
DIRECCIÓN: P.I. EL CASTILLO, C/ AALBORG, 9 03630 SAX (ALICANTE)
Nº CERTIFICADO: 13_03698-1

VENTANA DE PVC OSCILOBIANTE DOS HOJAS P. CIERRE STANDARD (1.555 x 1.215)mm
REF. «DECEUNINCK - HÄUSEN»

ENSAYO	RESULTADO
PERMEABILIDAD AL AIRE (UNE-EN 1026:2000)	CLASE 4
ESTANQUIDAD AL AGUA (UNE-EN 1027:2000)	CLASE 4A
RESISTENCIA A LA CARGA DE VIENTO (UNE-EN 12211:2000)	CLASE C5

Fecha de emisión: 28 de Noviembre de 2013

Los resultados obtenidos en estos ensayos solo se refieren a la(s) muestra(s) analizada(s) en este Centro en la fecha indicada y no implican una característica de consistencia en la calidad de la producción.
Este certificado no podrá ser reproducido sin la autorización expresa de TECNALIA, excepto cuando se use de forma íntegra.

Foto: Miguel Malvar, Responsable Técnico

Área Análisis - C-20750 Apapita (España) - T: +34 965 430 850 (internacional calls)

tecnalia Inspiring Business

www.tecnalia.com

Notificación de Ensayo y Clasificación

EMPRESA: HÄUSEN S.L.
DIRECCIÓN: P.I. EL CASTILLO, C/ AALBORG, 9 03630 SAX (ALICANTE)
Nº CERTIFICADO: 13_03697-1

VENTANA DE PVC OSCILOBIANTE DOS HOJAS P. CIERRE STANDARD (1.560 x 1.220)mm
REF. «REHAU - HÄUSEN»

ENSAYO	RESULTADO
PERMEABILIDAD AL AIRE (UNE-EN 1026:2000)	CLASE 3
ESTANQUIDAD AL AGUA (UNE-EN 1027:2000)	CLASE 6A
RESISTENCIA A LA CARGA DE VIENTO (UNE-EN 12211:2000)	CLASE C5

Fecha de emisión: 28 de Noviembre de 2013

Los resultados obtenidos en estos ensayos solo se refieren a la(s) muestra(s) analizada(s) en este Centro en la fecha indicada y no implican una característica de consistencia en la calidad de la producción.
Este certificado no podrá ser reproducido sin la autorización expresa de TECNALIA, excepto cuando se use de forma íntegra.

Foto: Miguel Malvar, Responsable Técnico

Área Análisis - C-20750 Apapita (España) - T: +34 965 430 850 (internacional calls)

tecnalia Inspiring Business

www.tecnalia.com

Notificación de Ensayo y Clasificación

EMPRESA: HÄUSEN S.L.
DIRECCIÓN: P.I. EL CASTILLO, C/ AALBORG, 9 03630 SAX (ALICANTE)
Nº CERTIFICADO: 13_03697-1

VENTANA DE PVC OSCILOBIANTE DOS HOJAS P. CIERRE STANDARD (1.570 x 1.220)mm
REF. «VEKA - HÄUSEN»

ENSAYO	RESULTADO
PERMEABILIDAD AL AIRE (UNE-EN 1026:2000)	CLASE 4
ESTANQUIDAD AL AGUA (UNE-EN 1027:2000)	CLASE E1200
RESISTENCIA A LA CARGA DE VIENTO (UNE-EN 12211:2000)	CLASE C5

Fecha de emisión: 28 de Noviembre de 2013

Los resultados obtenidos en estos ensayos solo se refieren a la(s) muestra(s) analizada(s) en este Centro en la fecha indicada y no implican una característica de consistencia en la calidad de la producción.
Este certificado no podrá ser reproducido sin la autorización expresa de TECNALIA, excepto cuando se use de forma íntegra.

Foto: Miguel Malvar, Responsable Técnico

Área Análisis - C-20750 Apapita (España) - T: +34 965 430 850 (internacional calls)

WARRANTY CERTIFICATE

Häusen®

10 YEAR WARRANTY CERTIFICATE

GIVES A 10 YEARS GUARANTEE FOR THE PRODUCTS WHICH ARE MANUFACTURED BY HÄUSEN FACTORY, STARTING FROM THE PURCHASING (INVOICE) DATE OF THE GOODS.
THIS GUARANTEE COVERS THE STABLE MECHANICAL WORKING OF THE GOODS, THE PAINT AND THE COATING OF THE GOODS AND THE MAINTAINABILITY OF CASTING, RONSEHET AND PLASTIC PARTS.

THIS WARRANTY IS NOT VALID FOR FOLLOWING CONDITIONS:

- CHANGES ABOUT CORROSION;
- STOCKING THE GOODS IN A HUMID PLACE;
- CLEANING THE GOODS BY USING CHEMICAL LIQUIDS;
- THE PROBLEMS WHICH ARE CAUSED BY AN EXTRAORDINARY TRANSPORTATION;
- CHANGES ABOUT ASSEMBLING;
- ASSEMBLING THE GOODS WITHOUT CORRESPONDING THE INSTRUCTIONS;
- USING DIFFERENT DIMENSIONS OF GOODS WHICH IS NOT REQUIRED TO USE;
- COMBINING THE GOODS WITH OTHER BRANDED GOODS;
- CUTTING OR MAKING CHANGES ON THE PRODUCT WHICH CAN CAUSE DEFORMATIONS OF MECHANICAL SYSTEM;
- NOT TO CLEAN ASSEMBLING AREA BEFORE THE ASSEMBLING PROCESS;
- NOT TO MAKE PERIODIC SERVICING LIKE EXPLAINED IN INSTRUCTIONS;
- NOT TO KEEP THE GOODS AGAINST CONSTRUCTION OR OTHER KINDS OF WASTE;
- USING THE GOODS WITH DIFFERENT PURPOSES AND IN DIFFERENT PLACES.

Häusen
Cumburjet Caddesi No: 42
Dortler Apt - Elmadağ
80200 ISTANBUL - TURKEY

tecnalia Inspiring Business

www.tecnalia.com

Notificación de Ensayos y Clasificación

EMPRESA: JAN COSTABLANCA, S.L.
DIRECCIÓN: P.I. EL CASTILLO, C/ AALBORG, 15-A 03630 SAX (ALICANTE)
Nº INFORME ASOCIADO: 075630

VENTANA DE PVC OSCILOBIANTE DOS HOJAS (1.200 x 1.500)mm
REF. «VENTANA OSCILOBIANTE DOBLE HOJA HAUSEN-ALPHACAN»

ENSAYO	RESULTADO
PERMEABILIDAD AL AIRE (UNE-EN 1026:2000)	CLASE 3
ESTANQUIDAD AL AGUA (UNE-EN 1027:2000)	CLASE E900
RESISTENCIA A LA CARGA DE VIENTO (UNE-EN 12211:2000)	CLASE C5

Fecha de ensayo: 26.07.2018
Fecha de emisión: 01.10.2018

Este resultado es el resumen de los datos indicados en el 'Informe de Ensayo' detallado en el apartado correspondiente.
Los resultados obtenidos en estos ensayos solo se refieren a la(s) muestra(s) analizada(s) en este Centro en la fecha indicada y no implican una característica de consistencia en la calidad de la producción.
Este certificado no podrá ser reproducido sin la autorización expresa de TECNALIA, excepto cuando se use de forma íntegra.

Foto: Ion Oñiza, Responsable Técnico

Área Análisis - C-20750 Apapita (España) - T: +34 965 430 850 (internacional calls)

SCHLÜSSEL-BESCHLÄGE

VERLEIHUNGS-URKUNDE

Die Gütegemeinschaft Schlösser und Beschläge e.V. verleiht hiermit aufgrund der ihrem Güteauschuss vorliegenden Prüfberichte dem Dreikippbeschlag

Based upon the test report which has been received for the quality assurance examination the quality assurance institution of locks and hardware items (versta, TS and Turn Hardware)

Häusen
the membership company

des von RAL (Deutsches Institut für Gütesicherung und Kennzeichnung eV) anerkannte und durch Ertragung beim Deutschen Patentamt als Kollektivmarke geschützte
Gütezeichen Schlösser und Beschläge mit der Inschrift "Dreikippbeschlag"

The RAL quality label (three keys), having been recognized by the German Patent Agency for Quality Assurance and having and trademark legally protected by the registration in the German Patent Agency - TS and Turn Hardware

in der Klasse 100 kg, geprüft nach RAL-GZ 407/3, Ausgabe 2009
approved in class 100 kg, according to RAL-GZ 407/3, version 2009

Die Führung des Zeichens setzt die Einhaltung und Überwachung nach dieser Güte- und Prüfbestimmung voraus. Die Kennzeichnung, die Gültigkeit und die Verantwortung Bestände des geprüften Produktes sind in dem gleichlaufenden Prüfbericht Nr. 4-28/09 beschrieben.
Permission of using the RAL label is based on correct observation of RAL-GZ 407/3 - quality and testing instructions. Labelling, validity and main components of tested product are detailed in test report no. 4-28/09 having same reference number.

D-42551 Velbert, den 24. September 2009

Gütegemeinschaft Schlösser und Beschläge e.V.

Geschäftsführer

Gütegemeinschaft Schlösser und Beschläge e.V. - Obere Straße 12 - D-42551 Velbert - Fax 02051/95060 - Fax 02052/950620

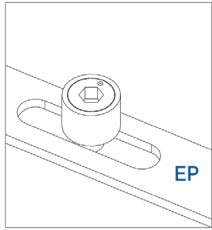

EP: Pin estandar

- Con su llave SW4 nos provee de la posibilidad de ajustar +/-0.8 mm la presión del marco de la ventana.
- Minimizando la fricción, este pin realiza una gran labor incluso con un gran apriete entre los perfiles.
- Es muy duradero gracias a su estructura especial que minimiza la fricción.
- Funciona con una productividad máxima y proporciona un gran acabado.

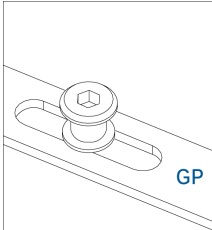

GP: Pin de Seguridad

- Con su llave SW4 nos provee de la posibilidad de ajustar +/-0.8 mm la presión del marco de la ventana.
- Su pin de seguridad diseñado de forma especial presenta un mayor nivel de seguridad que el EP, y provee la posibilidad de un trabajo aún más fácil.
- Está hecho de unos materiales especiales probados ante posibles rupturas.
- Funciona con una productividad máxima y proporciona un gran acabado.

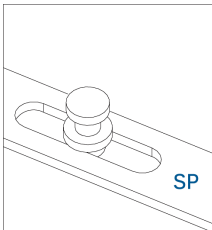

SP: Pin Deslizante

- Provee de la posibilidad de un uso duradero gracias a su forma especial.
- Está hecho de unos materiales especiales probados ante posibles rupturas.
- Funciona con una productividad máxima y proporciona un gran acabado.

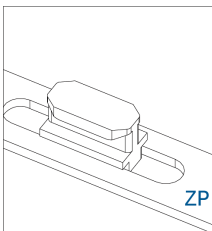

ZP: Pin Zamac

- Provee de la posibilidad de un largo y cómodo uso gracias a su forma especial.
- Presenta mayor seguridad que un pin deslizante estandar.
- Funciona con una productividad máxima y proporciona un gran acabado.

Máxima protección ante la corrosión

Los productos disponen de 1000 horas de protección ante la corrosión de acuerdo con el EN 9727.

A todos los accesorios se les aplica una nanocapa, estas capas son dos veces más estables que las capas normales de plata y zinc.

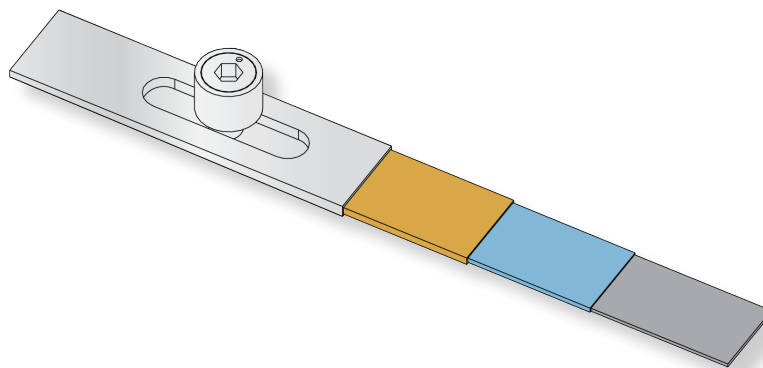

Superficie de metal sin capa

Antes del proceso de pintado, la protección ante la corrosión es muy pobre, después de ser aplicado el proceso de producción en crudo.



Capa Cromo +3

Se recubre la capa de Zinc, y este proceso proporciona brillo y tonalidad. Se maximiza la protección ante la corrosión en la superficie.



Capa de Zinc

La capa de Zinc es el primer paso para proteger el producto.



Tratamiento de la capa superior

Las capas de Zinc y la capa cromo evitan la contaminación y protegen la superficie.

• Oscilo-Batiente PVC	6
• Oscilo-Batiente C-16	9
• Corredera-traslante "Swing"	12
• Oscilo-Paralela "Kondor"	17
• Corredera-elevable "Leo"	19
• Sistema plegabke "Orión"	22
• Sistema oculto "Zenit"	24
• Sistema "Zenit View"	29
• Oscilo-batientes C.E.	33
• Sistema Lothus	35
• Herraje 40x40 / 40x20	38
• Herraje Cámara Europea	40
• Corredera	57
• Projectante	77
• Antipánicos	79
• Cerraduras y cilindros	85
• Manillas	98
• Asas y tiradores	131
• Aireadores y rejillas	137
• Claraboyas	138
• Ventanas de techo	140
• Escaleras escamoteables	142
• Apertura a distancia	143
• Automatismos	145
• Puertas y dinteles	152
• Abrepuertas eléctricos	155
• Cierrapuertas	159
• Bajopuertas automáticos	163
• Tornillería	166
• Barandillas	178
• Guías para corredera	187
• Garras y premarcos	188
• Calzos de acristalar	189
• Herramientas varias	190
• Químicos	192
• Gomas y juntas	193
• Cintas autoexpansivas	196
• Escuadras	197
• Pletina falleba	208

Häusen[®]
Accesorios para puertas y ventanas



Descargue el
catálogo completo



2024/1

PVC
SISTEMAS

- Hoja activa
- Seguridad
- Ángulo inferior

OB - Oscilo batiente.
 SH - Simple hoja.
 CV - Cota variable.
 SEG - Bulón seguridad.
 A.INF - Ángulo inferior.

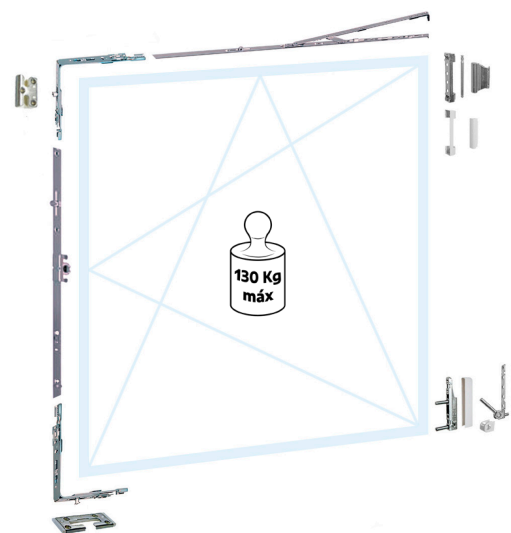

DESCRIPCIÓN	EJE	RAL	REF
Kit OB PVC SH CV Seg A.Inf 13mm 9016	13mm	9016	P1842-9016
GR: 01 - Cremona OB CV 15mm (585-1.000)	---	---	P1002
GR: 02-1 - Compás (395-600)	---	---	P1100

- Hoja activa
- Estándar
- Ángulo inferior

OB - Oscilo batiente.
 SH - Simple hoja.
 CV - Cota variable.
 STD - Bulón estándar.
 A.INF - Ángulo inferior.

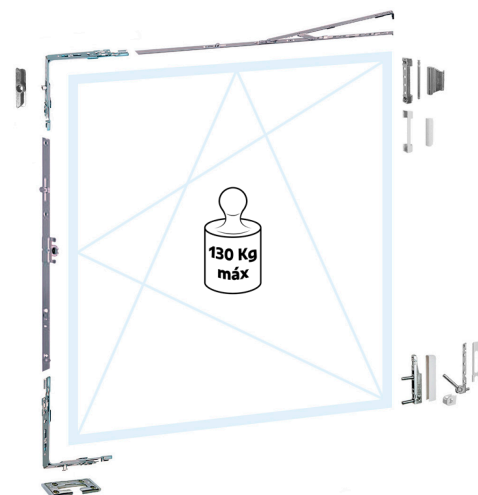

DESCRIPCIÓN	EJE	RAL	REF
Kit OB PVC SH CV Std. A.Inf 13mm 9016	13mm	9016	P1858-9016
GR: 01 - Cremona OB CV 15mm (585-1.000)	---	---	P1002
GR: 01-1 - Compás (395-600)	---	---	P1100

- Hoja activa
- Estándar
- Cierre lateral

OB - Oscilo batiente.
 SH - Simple hoja.
 CV - Cota variable.
 STD - Bulón estándar.
 C.LAT - Cierre lateral.

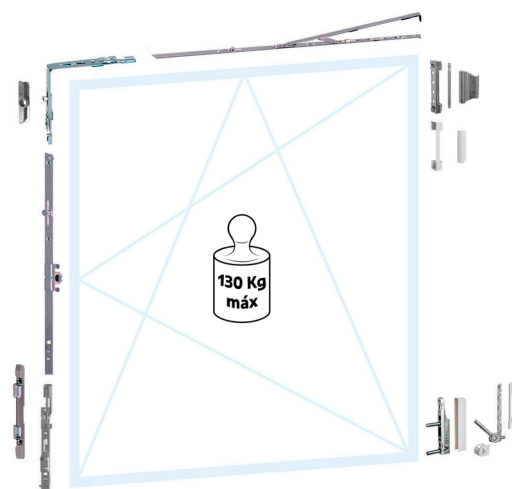

DESCRIPCIÓN	EJE	RAL	REF
Kit OB PVC SH CV Std. C.Lat. 13mm 9016	13mm	9016	P2158-9016
GR: 01 - Cremona OB CV 15mm (585-1.000)	---	---	P1002
GR: 01-1 - Compás (395-600)	---	---	P1100

- Hoja pasiva
- Seguridad
- Pasador palanca

OB - Oscilo batiente.
 2ªH - Segunda hoja.
 CV - Cota variable.
 SEG - Bulón seguridad.
 A.INF - Ángulo inferior.

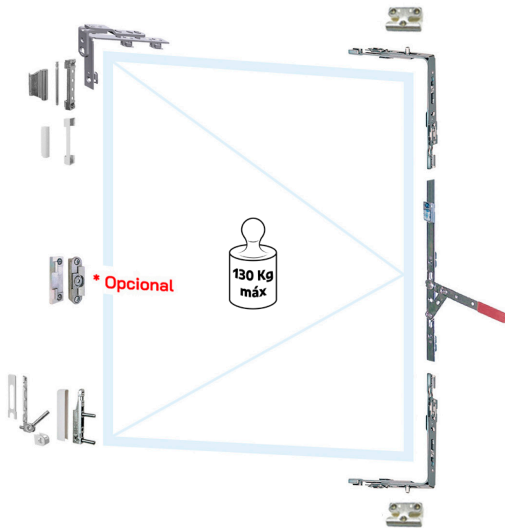

DESCRIPCIÓN	EJE	RAL	REF
Kit OB PVC 2ªH CV Seg. A.Inf 13mm 9016	13mm	9016	P1836-9016
GR: 01 - Pasador palanca CV (585-1.000)	---	---	P1801

- Hoja pasiva
- Estándar
- Pasador palanca

OB - Oscilo batiente.
 2ªH - Segunda hoja.
 CV - Cota variable.
 STD - Bulón estándar.
 A.INF - Ángulo inferior.

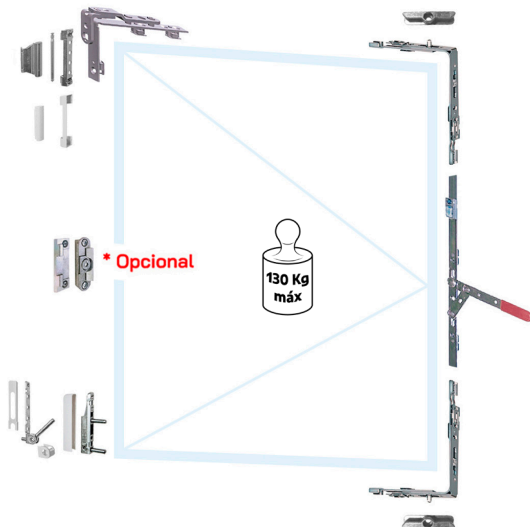

DESCRIPCIÓN	EJE	RAL	REF
Kit OB PVC 2ªH CV Std. A.Inf. 13mm	13mm	9016	P1835-9016
GR: 01 - Pasador palanca CV (585-1.000)	---	---	P1801

- Hoja pasiva
- Pasadores

OB - Oscilo batiente.
 2ªH - Segunda hoja.
 PAS - Pasadores.

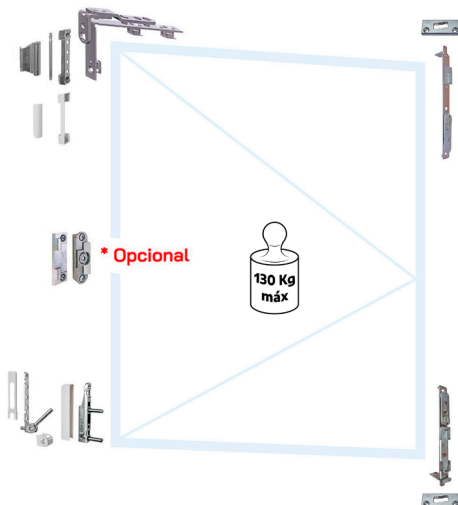

DESCRIPCIÓN	EJE	RAL	REF
Kit OB PVC 2ªH Pas. 13mm 9016	13mm	9016	P2159-9016

CANAL-16



Descargue el
catálogo completo

OSCILO-BATIENTE



- Hoja activa
- Seguridad
- Bisagra atornillada
- Cierre lateral

- OB - Oscilo batiente.
- SH - Simple hoja.
- CF - Cota fija.
- SEG - Bulón seguridad.
- C.LAT - Cierre lateral.
- B.ATO - Bisagra atornillada.

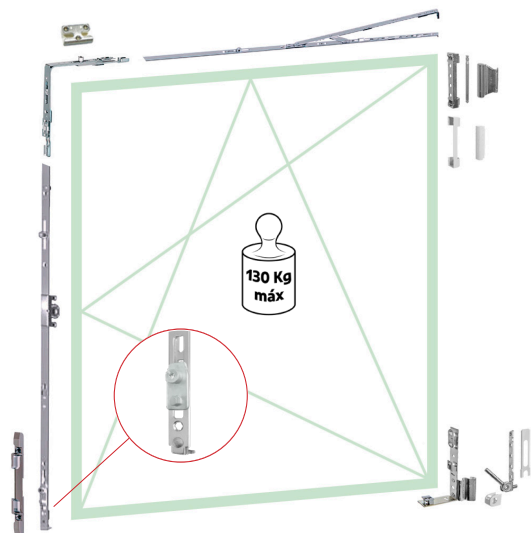

DESCRIPCIÓN	EJE	RAL	REF
Kit O.B. C-16. SH CV Seg. C.Lat. B.Ator. 13mm blanco	13mm	9016	P203D-9016
GR: 01 - Cremona OB CV Seg. 15mm (585-1.000)	---	---	P1002
GR: 02-1 - Compás seguridad (395-600)	---	---	P1100

- Hoja activa
- Seguridad
- Bisagra atornillada
- Reenvío inferior

- OB - Oscilo batiente.
- SH - Simple hoja.
- CF - Cota fija.
- SEG - Bulón seguridad.
- R.INF - Reenvío inferior.
- B.ATO - Bisagra atornillada.

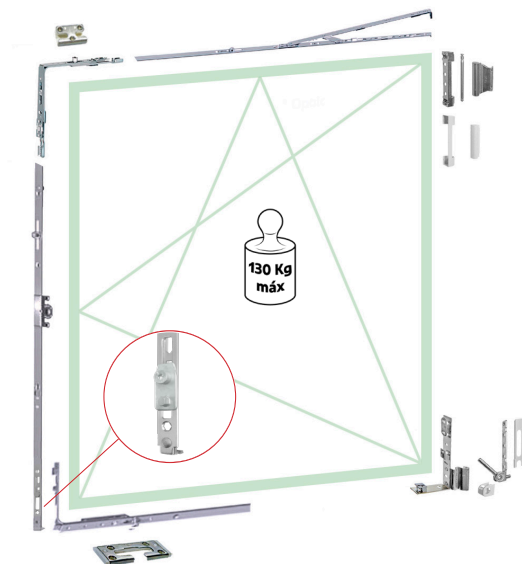

DESCRIPCIÓN	EJE	RAL	REF
Kit O.B. C-16 S.H. C.F. Seg. R.Inf. B.Ator 13mm 9016	13mm	9016	P204D-9016
GR: 01 - Cremona OB c/fija Seg. 15mm (501-700)	---	---	P1070
GR: 02-1 - Compás bulón seguridad (395-600)	---	---	P1100
GR: 00 - Reenvío bulón seguridad (400-800)	---	---	P1401

- Hoja pasiva
- Seguridad
- Bisagra atornillada
- Reenvío inferior

- OB - Oscilo batiente.
- 2ªH - Segunda hoja.
- CF - Cota fija.
- SEG - Bulón seguridad.
- R.INF - Reenvío inferior.
- B.ATO - Bisagra atornillada.

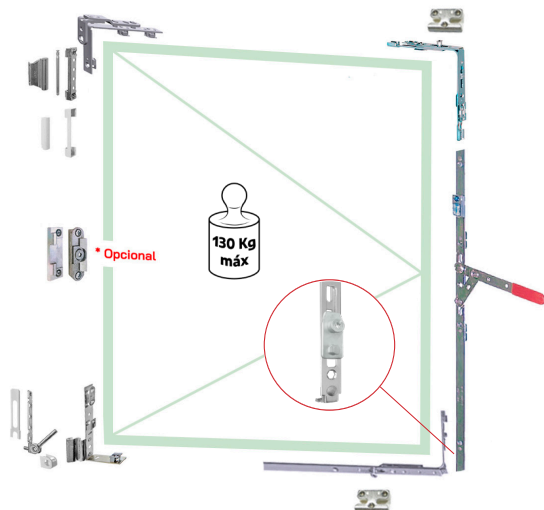

DESCRIPCIÓN	EJE	RAL	REF
Kit O.B. C-16. 2ªH CF Seg. R.Inf B.Ator. 13mm 9016	13mm	9016	P2050I-9016
Pasador palanca cota fija (501-700)	---	---	P1861
GR: 00 - Reenvío bulón seguridad (400-800)	---	---	P1401

- Hoja activa
- Seguridad
- Bisagra a canal
- Cierre lateral

OB - Oscilo batiente.
 SH - Simple hoja.
 CV - Cota variable.
 SEG - Bulón seguridad.
 C.LAT - Cierre lateral.
 B.CAN - Bisagra a canal.

DESCRIPCIÓN	EJE	RAL	REF
Kit O.B. C-16 SH CV Seg. C.Lat B.Can. 13mm blanco	13mm	9016	P1885-9016
GR: 01 - Cremona OB CV Seg. 15mm (585-1.000)	---	---	P1002
GR: 02-1 - Compás seguridad (395-600)	---	---	P1100

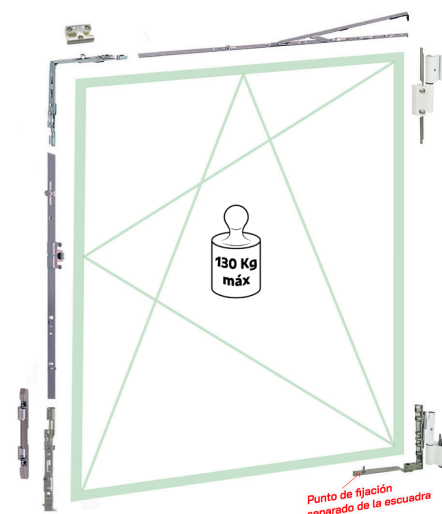

- Hoja activa
- Seguridad
- Bisagra a canal
- Angulo inferior

OB - Oscilo batiente.
 SH - Simple hoja.
 CV - Cota variable.
 SEG - Bulón seguridad.
 A.INF - Ángulo inferior.
 B.CAN - Bisagra a canal.

DESCRIPCIÓN	EJE	RAL	REF
Kit O.B. C-16 SH CV Seg. A.Inf. B.Can. 13mm blanco	13mm	9016	P2150-9016
GR: 01 - Cremona OB CV Seg. 15mm (585-1.000)	---	---	P1002
GR: 02-1 - Compás seguridad (395-600)	---	---	P1100

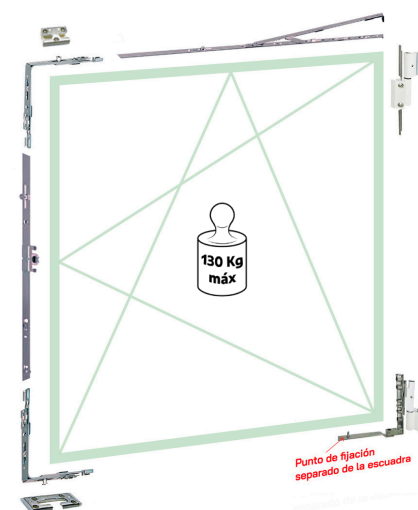

- Hoja pasiva
- Seguridad
- Bisagra a canal
- Angulo inferior

OB - Oscilo batiente.
 S^aH - Segunda hoja.
 CV - Cota variable.
 SEG - Bulón seguridad.
 A.INF - Ángulo inferior.
 B.CAN - Bisagra a canal.

DESCRIPCIÓN	EJE	RAL	REF
Kit O.B. C-16. 2ªH CV Seg. A.Inf. B.Can. 13mm 9016	13mm	9016	P2051-9016
GR: 01 - Pasador palanca CV (585-1.000)	---	---	P1801

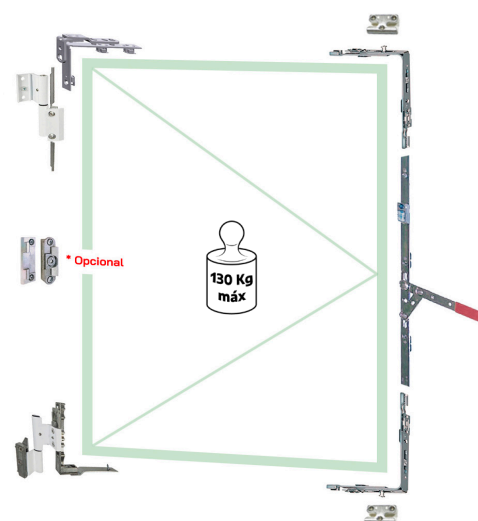



Descargue el
catálogo completo

SISTEMAS TRANSLANTE SILVER y SWING

deceuninck

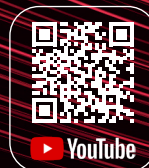
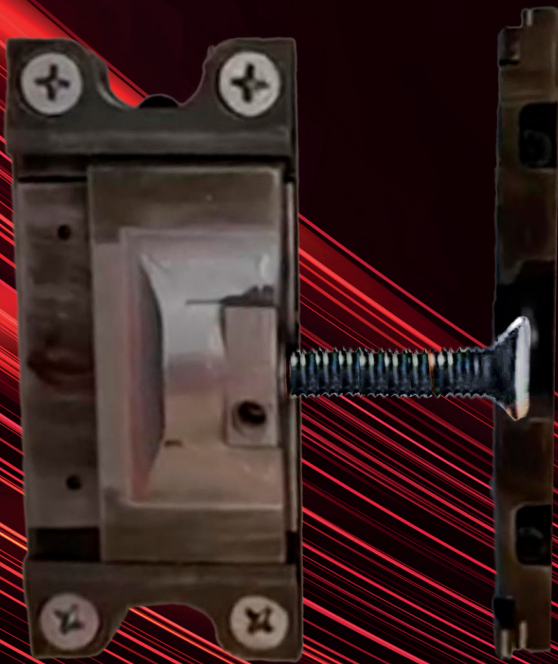

Video de
muestra



Montaje
Virtual

Häusen®
Accesorios para puertas y ventanas

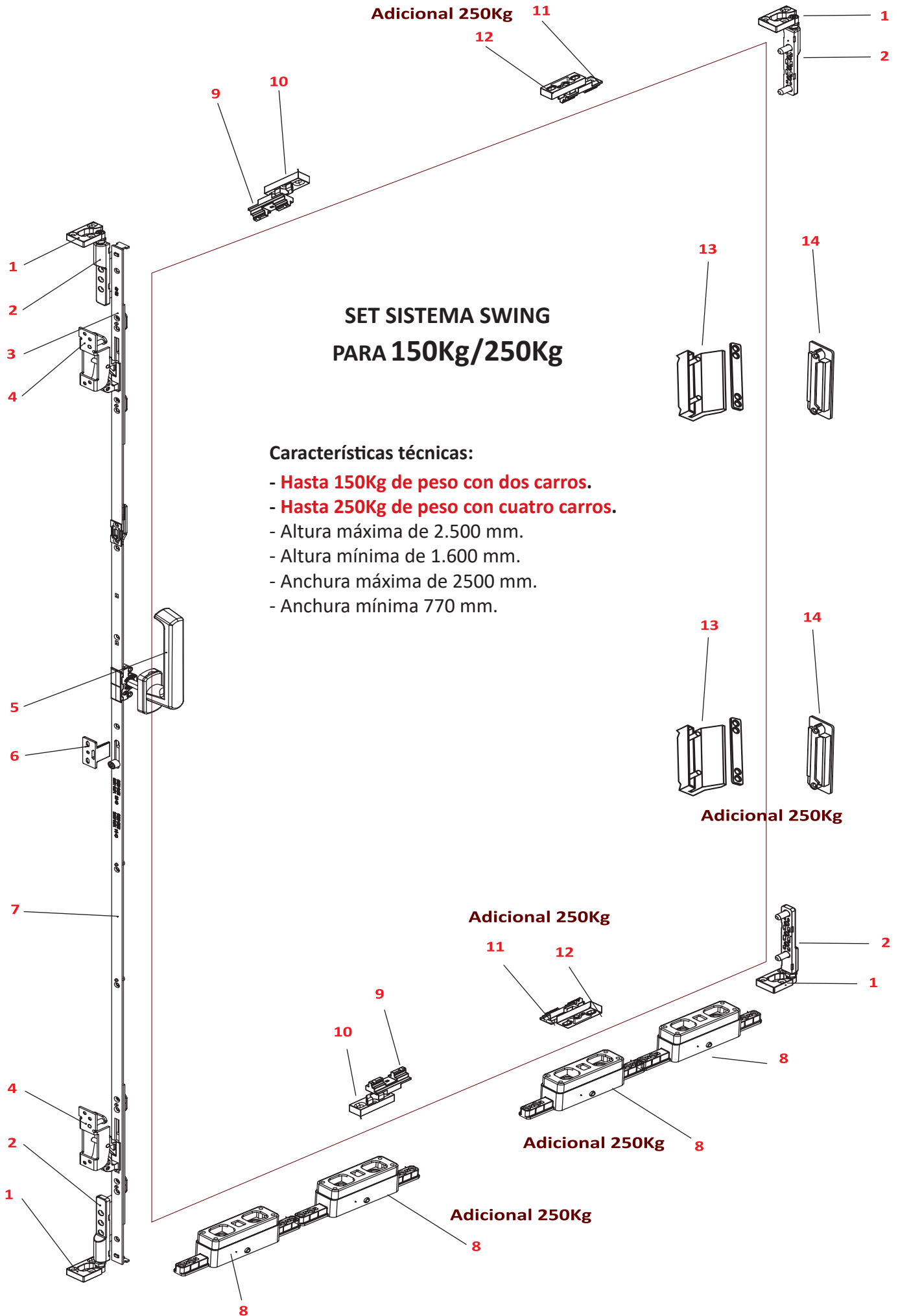











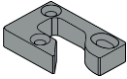





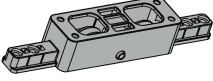

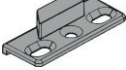
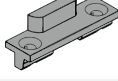
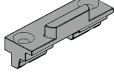
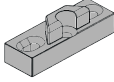
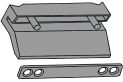

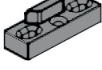
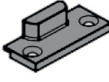

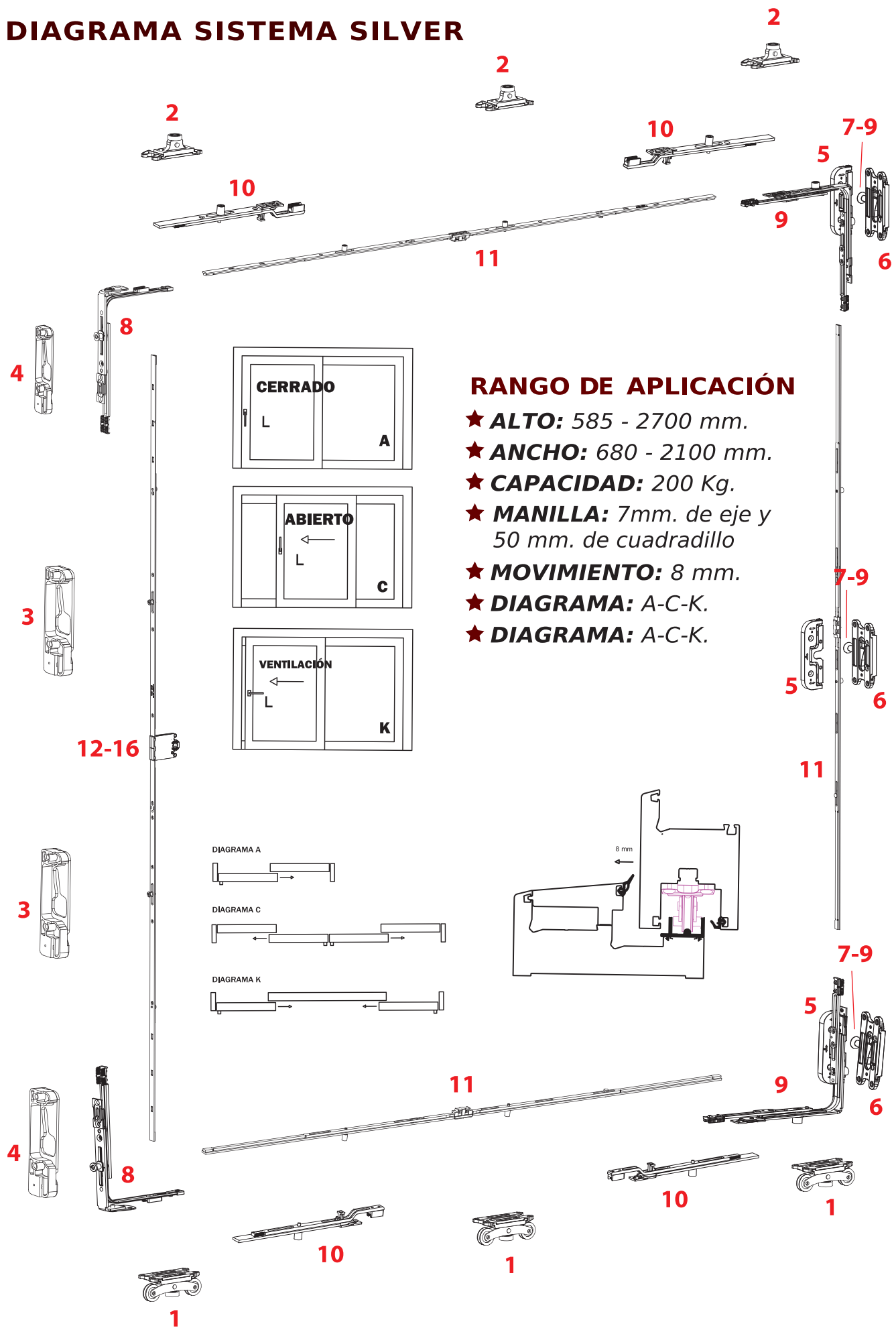
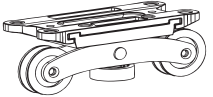
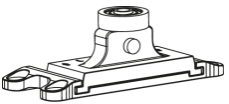
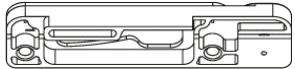
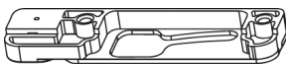
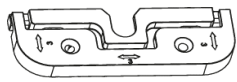
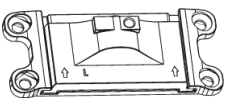
NUMERO	REF.	DESCRIPCION	
1	P4708	CERRADERO PARA PUNTERO SUPERIOR/INFERIOR	
2	P4707	PUNTERO DE CIERRE LATERAL SUPERIOR INFERIOR EN HOJA	
3	-	PROLONGADOR CREMONA	
4	P4706	CERRADERO LATERAL PARA CREMONA Y PROLONGADOR	
5	-	CREMONA CON CUADRADILLO	
6	P4711	CERRADERO LATERAL PARA BULON EXCENTRICO	
7	-	CREMONA CON GANCHO	
7	-	CREMONA CON GANCHO Y CERRADURA	
8	P4705	CARRO / RUEDA INFERIOR	
-	P4714	CALZO PARA RUEDA	
9	P4709	CERRADERO DELANTERO SUPERIOR/INFERIOR EN HOJA	
10	P4710	CERRADERO DELANTERO SUPERIOR/INFERIOR EN MARCO	
11	P4730	CERRADERO SUPERIOR/INFERIOR EN HOJA ADICIONAL 250 kg	
12	P4731	CERRADERO SUPERIOR/INFERIOR EN MARCO ADICIONAL 250 kg	
13	P4732	CERRADERO TRASERO EN HOJA ADICIONAL 250 kg	
14	P4733	CERRADERO TRASERO EN MARCO ADICIONAL 250 kg	
	P4719	CERRADERO SUPERIOR/INFERIOR KOMMERLING 250 kg MARCO	
	P4720	CERRADERO SUPERIOR/INFERIOR KOMMERLING 250 kg HOJA	
	P4749	CALZO PARA CERRADERO SUPERIOR/INFERIOR KOMMERLING 250 kg	
15	P4726	TOPE TRASERO	

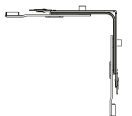
DIAGRAMA SISTEMA SILVER



NUMERO	REF.	DESCRIPCION	DIBUJO
1	P4610D	SILVER CARRO INFERIOR DERECHA TRASLANTE	
1	P4610I	SILVER CARRO INFERIOR IZQUIERDA TRASLANTE	
2	P4611D	SILVER GUIA CENTRAL SUPERIOR DERECHA	
2	P4611I	SILVER GUIA CENTRAL SUPERIOR IZQUIERDA	
3	P4612D	SILVER CERRADERO MARCO TRASLANTE DERECHA	
3	P4612I	SILVER CERRADERO MARCO TRASLANTE IZQUIERDA	
4	P4613D	SILVER CERRADERO MARCO TRASLANTE UNIVERSAL DERECHA	
4	P4613I	SILVER CERRADERO MARCO TRASLANTE UNIVERSAL IZQUIERDA	
5	P4614D	SILVER CERRADERO CENTRAL DERECHA	
5	P4614I	SILVER CERRADERO CENTRAL IZQUIERDA	
6	P4615	SILVER CERRADERO CENTRAL	
7	-	SILVER TORNILLO CONDENA	
8	P1053	ANGULO REENVIO PEQ. P.CIERRE SEG. SILVER	
9	P1055	ANGULO REENVIO 2 BULON STANDARD SILVER	
10	P1269	PROLONGADOR CONX CORTO SEG 210 mm ESPECIAL SILVER	
11	-	CONECTOR CREMONA VERTICAL SILVER	
12	-	CREMONA 40mm C.VAR. B.SEG. OB SILVER	
13	-	CREMONA 30mm C.VAR. B.SEG. OB SILVER	
14	-	CREMONA 15mm C.VAR. B.SEG. OB SILVER	
15	-	CREMONA 30 mm C.VAR. B.SEG. OB con llave SILVER	
16	-	CREMONA 40 mm C.VAR. B.SEG. OB con llave SILVER	

OSCILO-PARALELA KONDOR

ALUMINIO Y PVC



Descargue el
catálogo completo

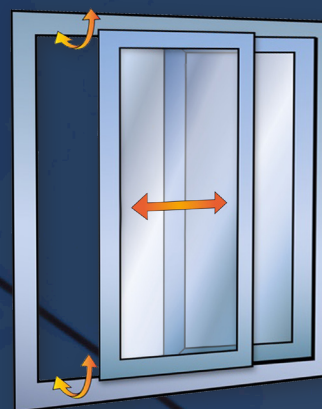

Vídeo
demostración
Aluminio



Vídeo
demostración
PVC



Montaje
Virtual



Oscilo-paralela Kondor Aluminio C.E.

***Nota:** se puede evitar poner fijos atornillando las guías sobre la pared.

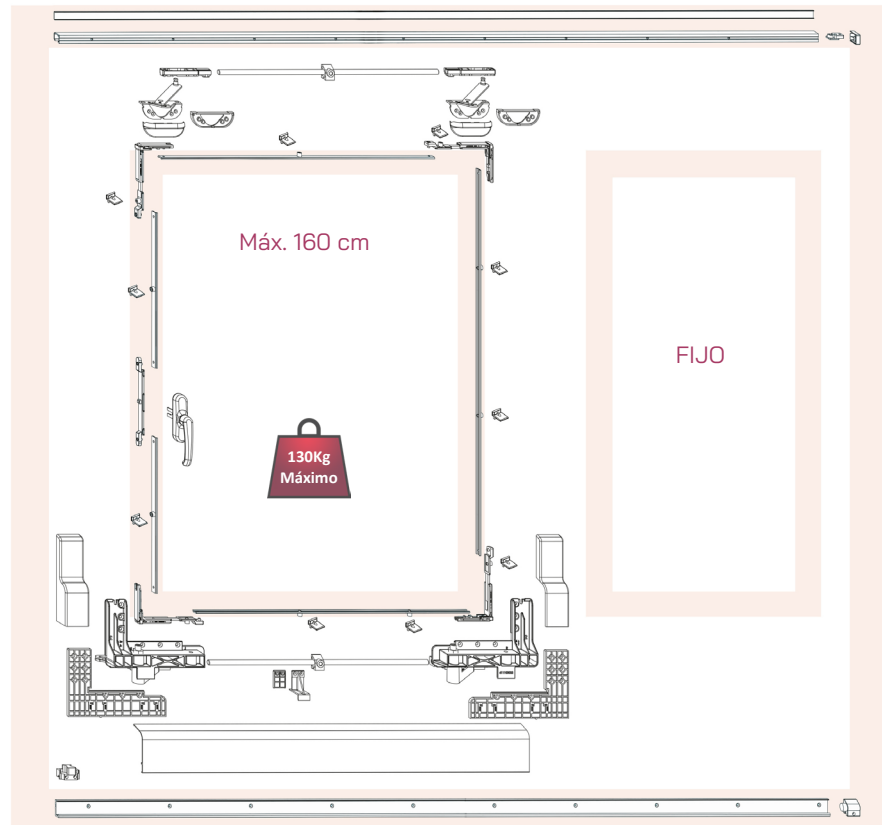

Oscilo-paralela Kondor PVC

***Nota:** se puede evitar poner fijos atornillando las guías sobre la pared.

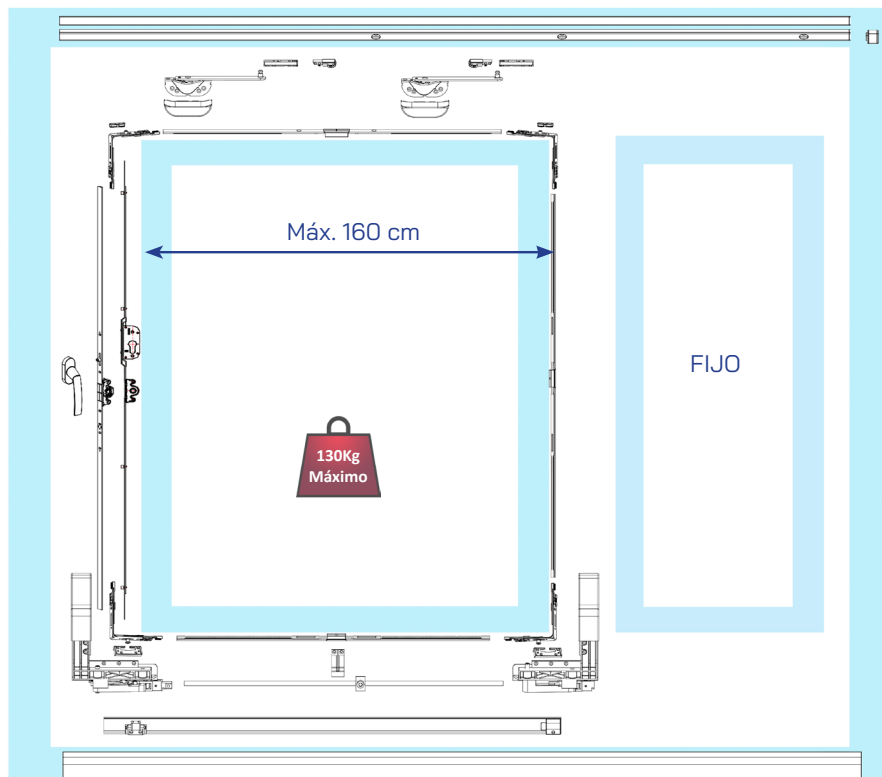

400Kg
Máximo



Descargue el
catálogo completo



Utilice la herramienta
configuradora de trabajos



YouTube

Montaje
Virtual

Montaje
Virtual

* 400Kg con dos
carros adicionales

Häusen[®]
Accesorios para puertas y ventanas

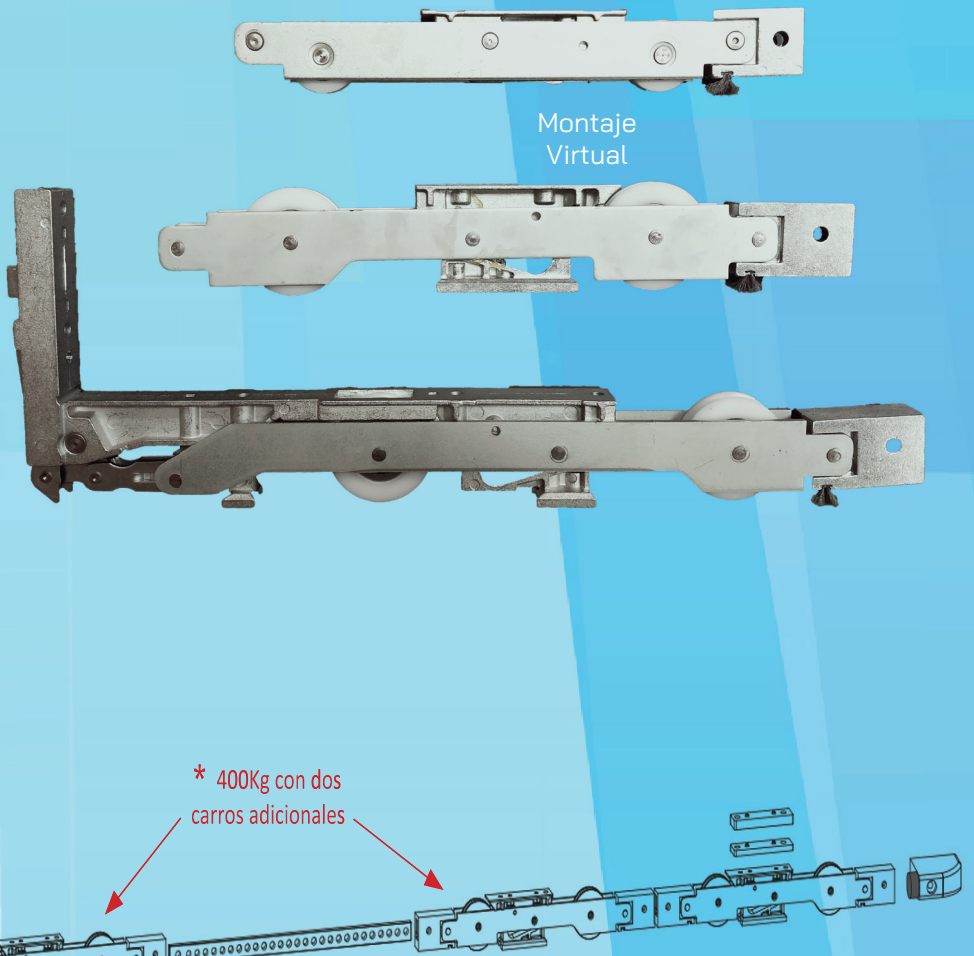
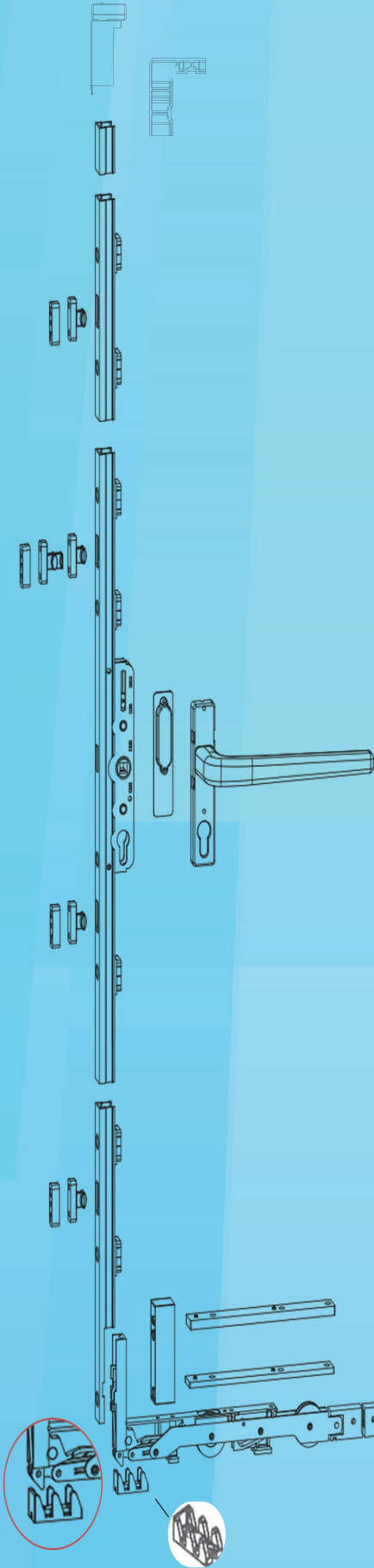

EJEMPLO ELEVABLE COMPLETA

- CREMONA
- VARILLA CONEXION
- CARRO DELANTERO
- CARRO TRASERO
- KIT DE HERRAJE ELEVABLE
- MANILLA CON UÑERO

200Kg
Máximo

300Kg
Máximo

E=27,5
E=37,5

Muelle retenedor del movimiento de la manilla

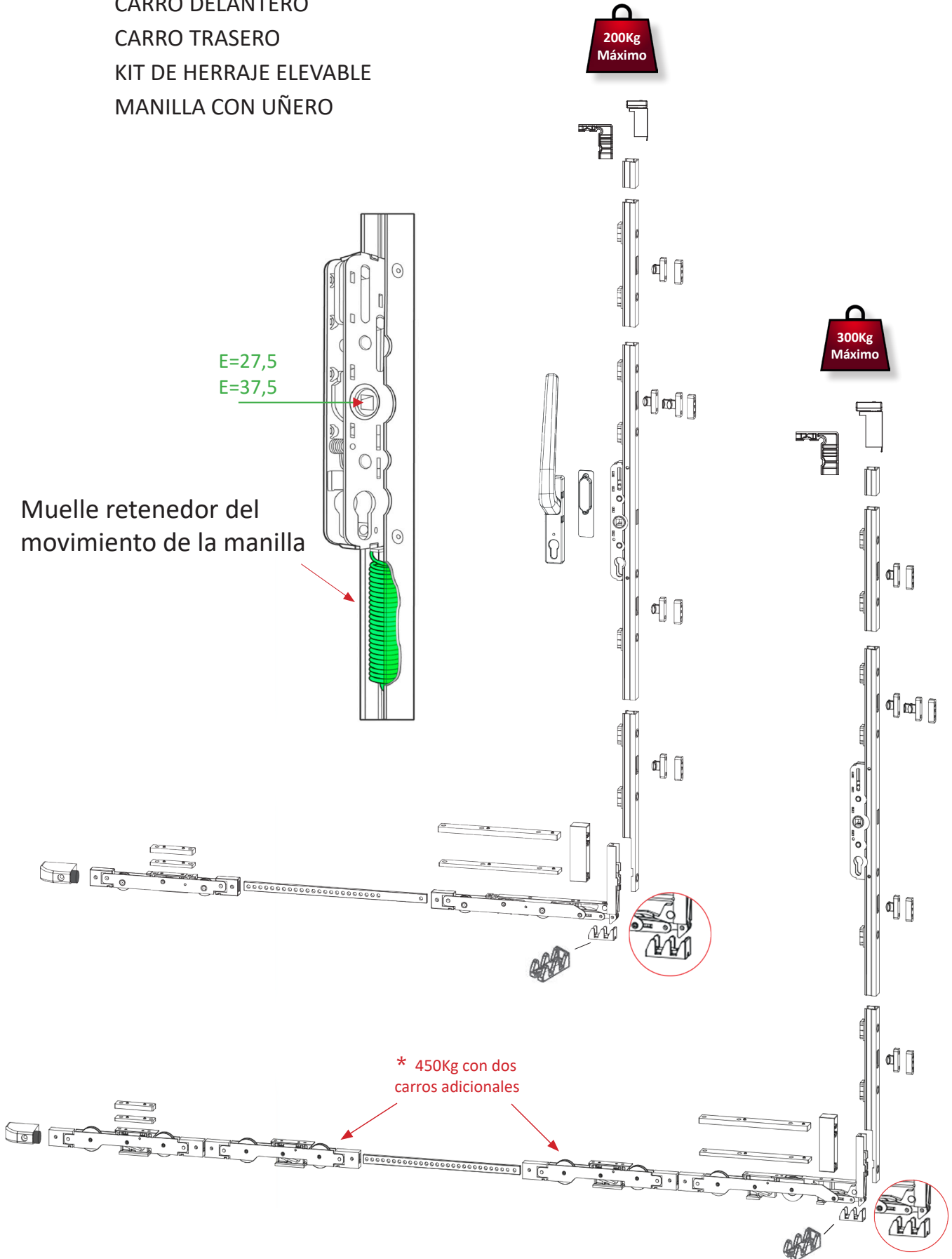

SERIES ALUMINIO

EV1648	ALCAR EUROPA AE9082 (37,5 - 300KG)
EV1656	ALLCO (37,5 - 300KG)
EV1679	ALUCAN AL-126 (37,5 - 300KG)
EV1680	ALUCAN AL-126 RPT (37,5 - 300KG)
EV1658	ALUEUROPA QSYSTEMS Q120 GRANDE (37,5 - 300KG)
EV1657	ALUEUROPA QSYSTEMS Q120 PEQUEÑA (27,5 - 200KG)
EV1608	ALUGOM MATRA 110 (27,5 - 200KG)
EV1607	ALUGOM MATRA 135RPT (37,5 - 300KG)
EV1675	ALUMED MAGNA EVA ALU HB (27,5 - 200KG)
EV1646	ALUVAL 300 HB (37,5 - 300KG)
EV1645	ALUVAL ALUPROM 23 (27,5 - 200KG)
EV1661	ALUVAL ALUPROM 30/31 (27,5 - 200KG)
EV1611	ALUVAL ALUPROM 40 (37,5 - 300KG)
EV1665	ALUVAL ALUPROM 42 (37,5 - 300KG)
EV1613	ANICOLOR CW 60 (27,5 - 200KG)
EV1614	AYUSO MAGNUM 200 ALU HB (27,5 - 200KG)
EV1615	AYUSO MAGNUM 400 ALU HB (37,5 - 300KG)
EV1616	CODEVAL ELEGANCE (37,5 - 300KG)
EV1617	CODEVAL PREMIER-100 (37,5 - 300KG)
EV1618	CORTIZO 4500 MARCO RECTO (37,5 - 300KG)
EV1619	CORTIZO 4500 PERIMETRAL (37,5 - 300KG)
EV1655	DOGMA HB ALU (37,5 - 300KG)
EV1606	DOMO 125 RT (37,5 - 300KG)
EV1652	EKU WOOD ART HB (37,5 - 300KG)
EV1647	EXALCO ALBIO 235 HB (27,5 - 200KG)
EV1622	EXLABESA GR PERIMETRAL (37,5 - 300KG)
EV1623	EXLABESA GR RECTO (37,5 - 300KG)
EV1667	EXLABESA RPT ALU (37,5 - 300KG)
EV1670	EXTOL CPT 110 E (37,5 - 300KG)
EV1625	EXTRUAL E-60 (37,5 - 300KG)
EV1620	EXTRUAL EURONOVA 100 (37,5 - 300KG)
EV1666	EXTRUAL EURONOVA 100 (37,5 - 300KG)
EV1621	EXTRUAL EURONOVA E-80RPT (27,5 - 200KG)
EV1624	EXTRUAL SERIE S-80 (27,5 - 200KG)
EV1659	EXTRUGAL S88RP (27,5 - 200KG)
EV1677	EXTRUGASA XS-160 TH HI (37,5 - 300KG)
EV1626	GALISUR GP 120 (37,5 - 300KG)
EV1605	GALISUR GPR120 (37,5 - 300KG)
EV1629	HYDRO - DOMAIL SLIDE 110 (27,5 - 200KG)
EV1630	INALUM MARINA 135 RPT (37,5 - 300KG)

SERIES ALUMINIO

EV1630	INALUM MARINA 135 RPT (37,5 - 300KG)
EV1632	INDALSU DOMO 125 RPT (37,5 - 300KG)
EV1676	INDALSU DOMO 160 RT (37,5/27,5 - 300KG)
EV1631	ITESAL IT-128-ELV (37,5 - 300KG)
EV1634	LAMINEX TITAN (37,5 - 300KG)
EV1633	LAMINEX TITAN RPT (37,5 - 300KG)
EV1654	MEXALL MX200 (27,5 - 300KG)
EV1651	PROFINE PREMIDOOR 76 (37,5 - 300KG)
EV1635	PROFINE PREMIDOR TT2 HB PVC (37,5 - 300KG)
EV1602	SERIE ALUMIAL 67 (27,5 - 200KG)
EV1638	SOPENA METALES 135 RT PERIMETRAL (37,5 - 300KG)
EV1639	SOPENA METALES 135 RT RECTA (37,5 - 300KG)
EV1612	STRUGAL ALUSWING 110 (37,5 - 300KG)
EV1672	STRUGAL ARTIS ELEVABLE (27,5 - 200KG)
EV1671	STRUGAL ILEVA (37,5 - 300KG)
EV1641	STRUGAL S110P (37,5 - 300KG)
EV1640	STRUGAL S125RP (37,5 - 300KG)
EV1642	VALENCIA ELV100 (27,5 - 200KG)

SERIES PVC

EV1650	ALPHACAN HST (37,5 - 300KG)
EV1609	ALUPLAST 70 HB PVC (37,5 - 300KG)
EV1610	ALUPLAST 85 HB PVC (37,5 - 300KG)
EV1644	CORTIZO E170 ELEVABLE PVC (37,5 - 300KG)
EV1669	DECEUNINCK EGEPEN HS 76 PVC (37,5 - 300KG)
EV1664	DECEUNINCK WINSA (37,5 - 300KG)
EV1668	DECEUNINCK WINSA PVC (37,5 - 300KG)
EV1660	DECEUNINCK HS76 (37,5 - 300KG)
EV1628	GEALAN 8000 HB PVC (37,5 - 300KG)
EV1603	KÖMMERLING 76LIFT (37,5-300KG)
EV1651	PROFINE PREMIDOOR 76 (37,5 - 300KG)
EV1635	PROFINE PREMIDOR TT2 HB PVC (37,5 - 300KG)
EV1678	REHAU BRILLANT PVC (37,5 - 300KG)
EV1636	REHAU GENE0 PVC HB (37,5 - 300KG)
EV1649	REHAU SYNEGO HB PVC (37,5 - 300KG)
EV1604	SALAMANDER HB PVC (37,5 - 300KG)
EV1637	SALAMANDER HB PVC (37,5 - 300KG)
EV1601	SERIE REHAU 712HB (37,5 - 300KG)
EV1653	VEKA LSD 153 HB PVC (37,5 - 300KG)
EV1643	VEKA SLIDE 70/82 HB PVC (27,5 - 300KG)

SISTEMA PLEGABLE

ORIÓN

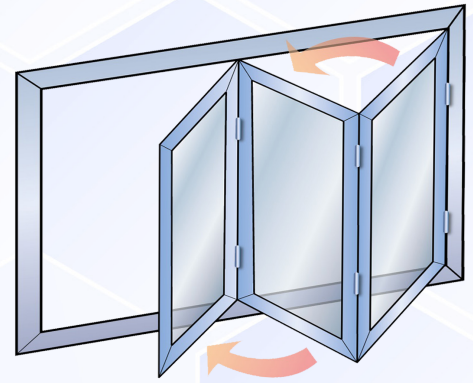

Opciones de color

RAL-9016	RAL-8022	RAL-9005	RAL-9006
----------	----------	----------	----------

Especificaciones técnicas

- Ancho de rebaje de la hoja SRW 450mm - max. 1200mm
- Ancho de rebaje de la hoja SRW 450mm - max. 900mm (Marco plegable)
- Ancho de rebaje de la hoja SRH 600mm - max. 2400mm
- Peso de la hoja (Kg) Máx. 100 Kg (Para la versión inferior)
- Peso de la hoja (Kg) Máx. 80 Kg (Para la versión superior)
- Longitud de la pista de rodillos Máx. 6m y 7 hojas



Montaje
Virtual



Utilice la herramienta
configuradora de trabajos

Catálogo plegable C.E.



Descargue el catálogo
completo Alu. C.E.

Catálogo plegable Canal-16

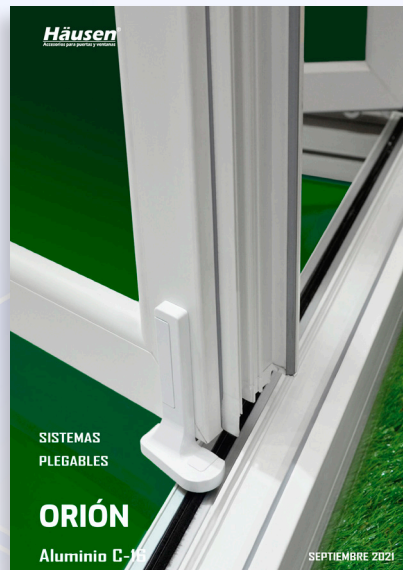

Descargue el catálogo
completo Alu. C-16

Catálogo plegable PVC



Descargue el catálogo
completo PVC

TIPOS DE SISTEMAS PLEGABLES

321
CON O.B.

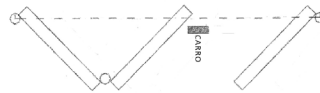
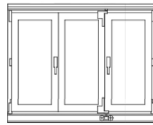

330

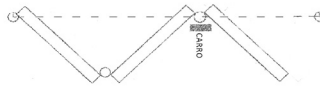
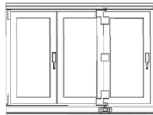

431
CON O.B.

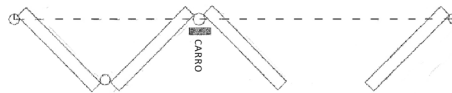
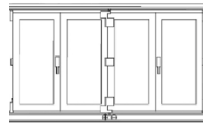

532

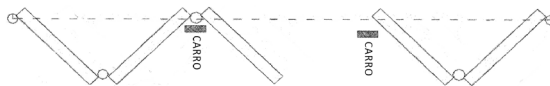
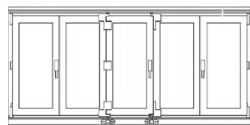

541
CON O.B.

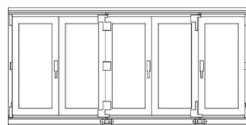

550

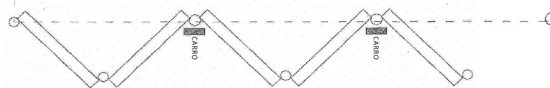
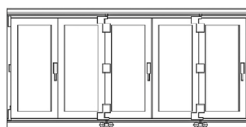

633

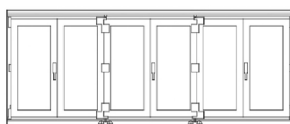

651
CON O.B.

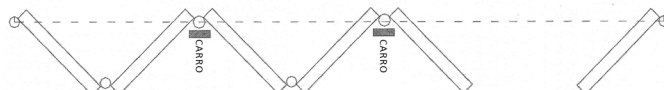
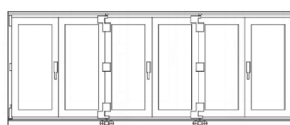

743

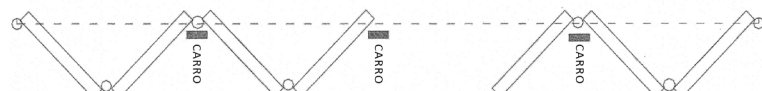
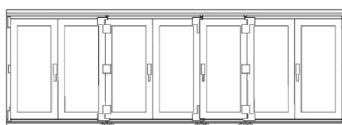

761
CON O.B.

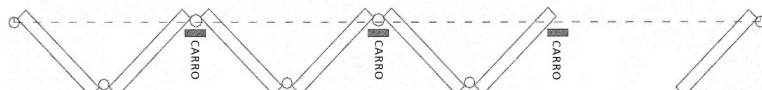
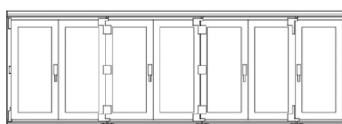

770

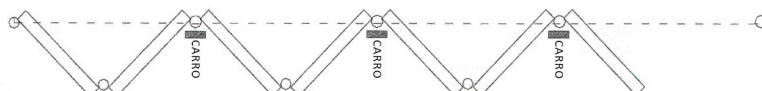
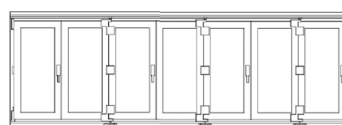

ZENIT

Sistema oculto Aluminio C.E.



Utilice la herramienta configuradora de trabajos



Descargue el catálogo completo



Video demostración



200°
APERTURA MÁXIMA



Tecnología anti-bacterias



1.000 horas de lluvia salina certificada

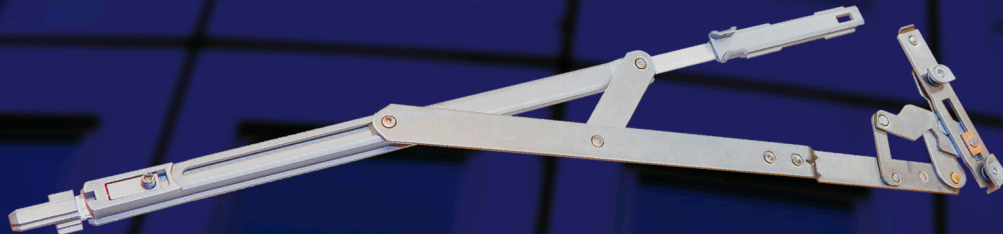



MEDIDAS DE CORTE PLETINA FALLEBA

- Cremona Joe: L1 = A -205 / L2 = B -205
- Cremona Corvair: L1 = A -260 / L2 = B -260
- Cremona Yak: L1 = A -170 / L2 = B -170
- Cremona Atenea: L1 = A -170 / L2 = B -170
- Compás pequeño: L3 = C - 410
- Compás grande: L3 = C - 488
- Compás Twister pequeño: L3 = C - 450
- Compás Twister grande: L3 = C - 528

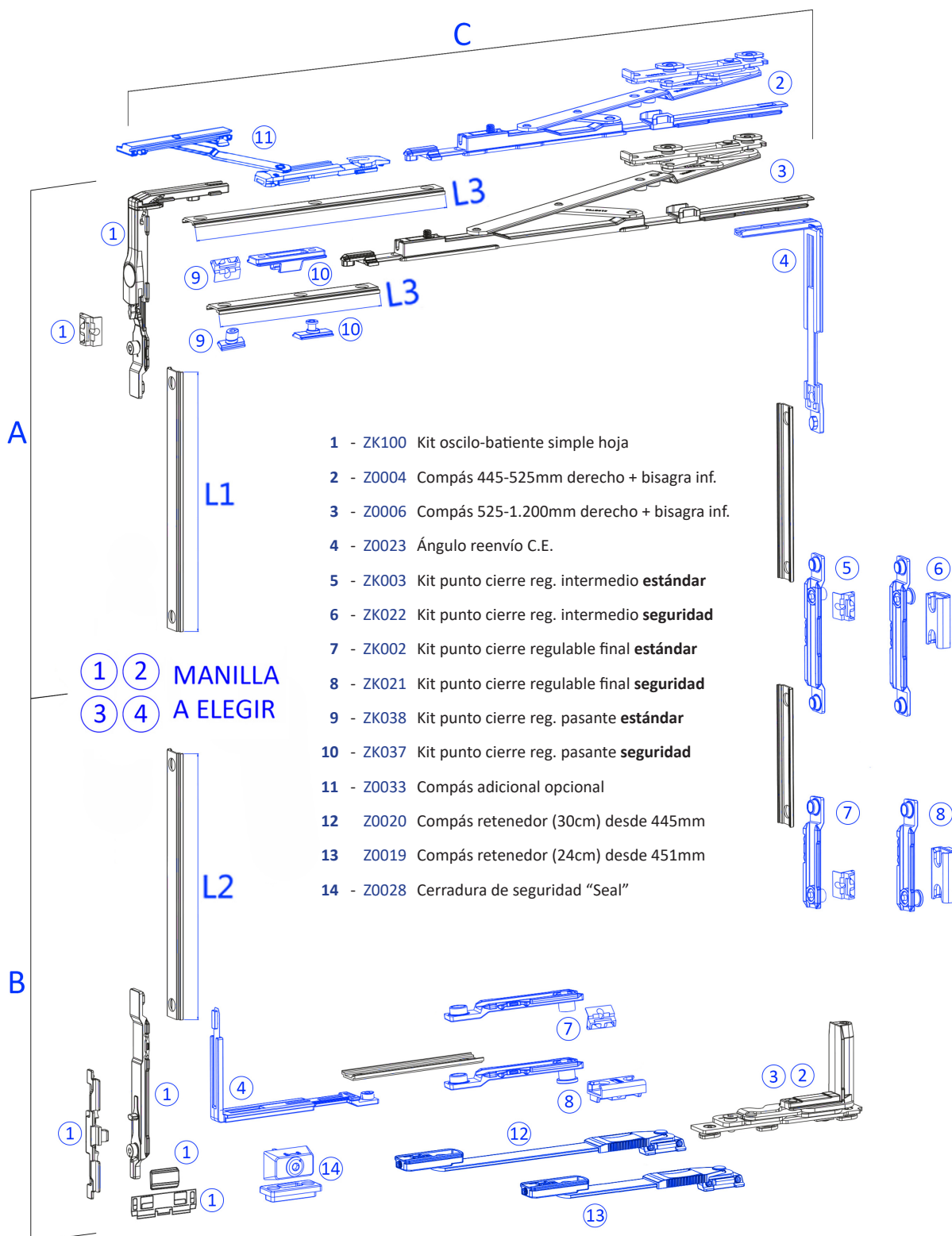

Compases oscilo-batiente oculto

	POSICIÓN		REF:
50	Derecha	445-525 mm	Z0004
50	Izquierda	445-525 mm	Z0005
50	Derecha	525-1.200 mm	Z0006
50	Izquierda	525-1.200 mm	Z0007



TIENDA



1.000 horas de lluvia salina certificadas

- Aplicación: Ventanas oscilo-batientes.
- Anchura de hoja: 445 - 525mm.
- Ángulo de apertura: 200°
- Acero inoxidable SS304.

Compases **Twister** con **antiviento** O.B. oculto

	POSICIÓN		REF:
50	Derecha	445-525 mm	Z0031
50	Izquierda	445-525 mm	Z0032
50	Derecha	525-1.200 mm	Z0029
50	Izquierda	525-1.200 mm	Z0030



1.000 horas de lluvia salina certificadas

- Aplicación: Ventanas oscilo-batientes.
- Anchura de hoja: 445 - 525mm.
- Ángulo de apertura: 200°
- Acero inoxidable SS304.

TIENDA



Los compases antiviento Twister disponen de un autofreno que evita que la hoja de portazo a causa de las corrientes de aire

Bisagras superiores de practicable oculto

	DESCRIPCIÓN	POSICIÓN	REF:
50	Bisagra superior izquierda	Izquierda	Z0022
50	Bisagra superior derecha	Derecha	Z0021



TIENDA



1.000 horas de lluvia salina certificadas

Bisagras inferiores de practicable oculto

	DESCRIPCIÓN	POSICIÓN	REF:
50	Bisagra inferior izquierda	Izquierda	Z0003
50	Bisagra inferior derecha	Derecha	Z0002

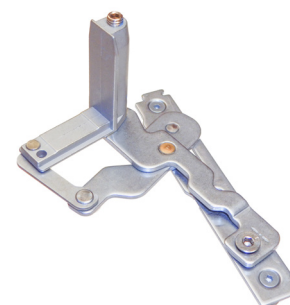

TIENDA



1.000 horas de lluvia salina certificadas

CONSULTE NUESTRO SERVICIO DE LACADO
PARA RALES ESPECIALES



SERVICIO DE PERSONALIZACIÓN
CON EL LOGO DE SU EMPRESA
CONSULTE CONDICIONES

MATRIZ TROQUELADORA PARA MECANIZADO CREMONA JOE

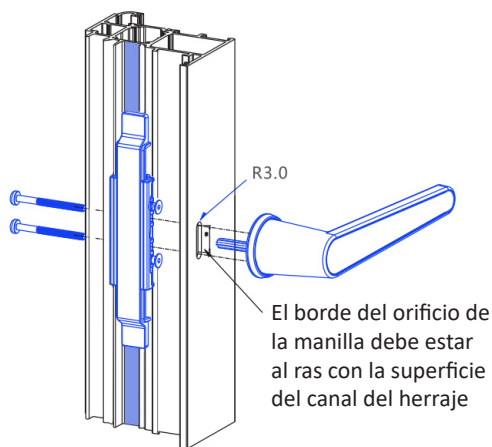

	DESCRIPCIÓN	REF:
1	Matriz troqueladora cremona	Z0044

TIENDA



Muestra de matriz

Destornillador 2,5mm especial para herraje



TIENDA



	REF.
12	Z0048

Destornillador punta bola especial para herraje

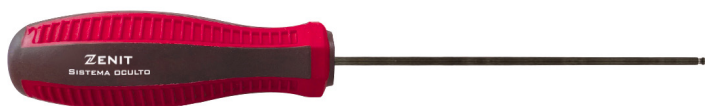

TIENDA



	REF.
12	Z0058

Extensa gama de colores disponibles.

COLORES ESPECIALES



- Z0001 - PALTA
PLATA V SEMIMATE



- Z0001 - GUNMETAL
GUNMETAL SEMIMATE



- Z0001 - GRAFITO2
GRAFITO SEMIMATE



- Z0001 - GRAFITO1
GRAFITO BRILLO



- Z0001 - OROV
ORO VIEJO SATINADO



- Z0001 - LATON
ORO LATÓN MATE



- Z0001 - ORO
ORO 367



- Z0001 - COBRE2
COBRE VIEJO SATINADO



- Z0001 - COBREV
COBRE V SEMIMATE



- Z0001 - COBRE2
COBRE VIEJO PIEDRA

ZENIT VIEW



HOJA PASIVA

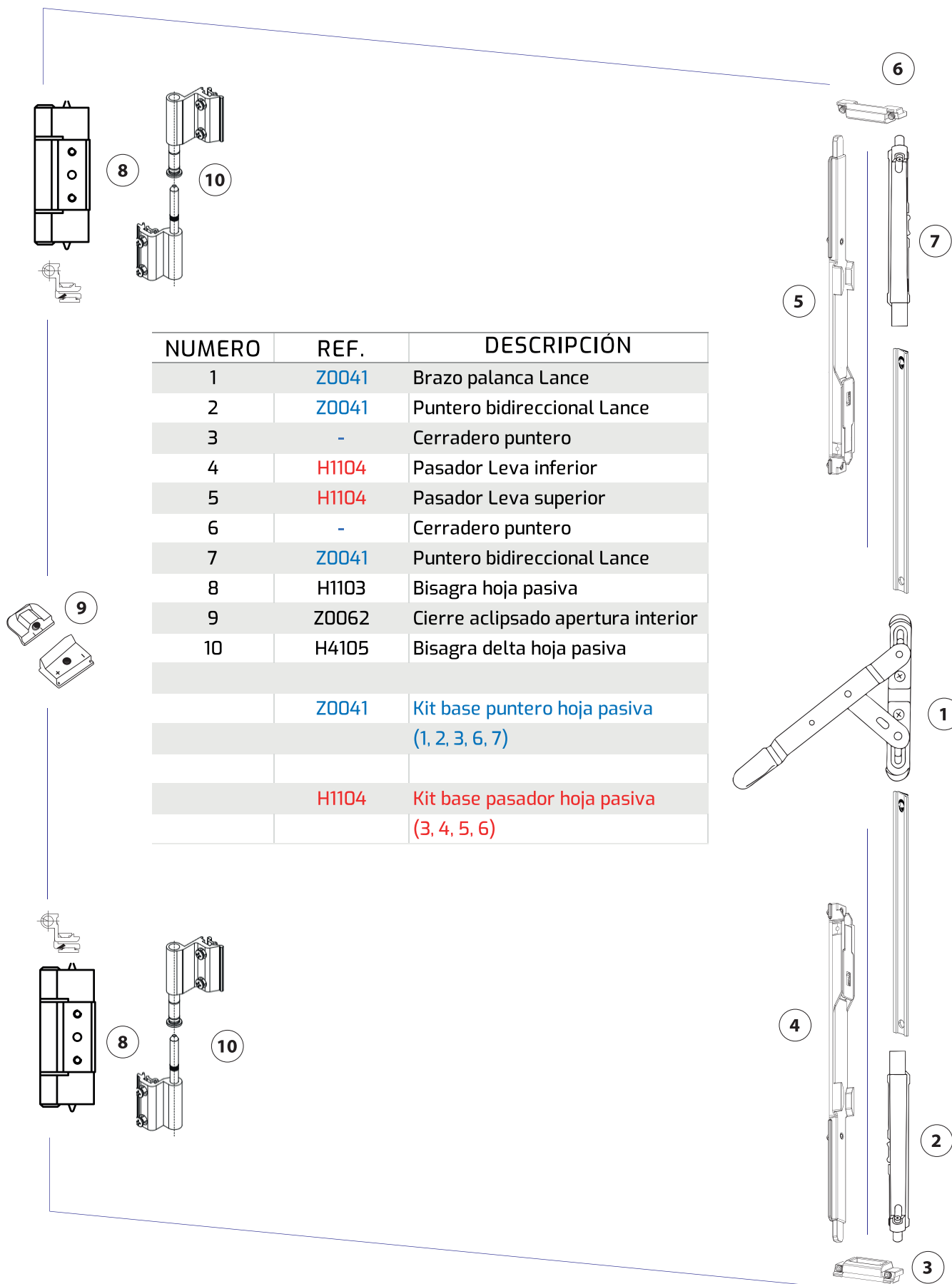

HOJA ACTIVA

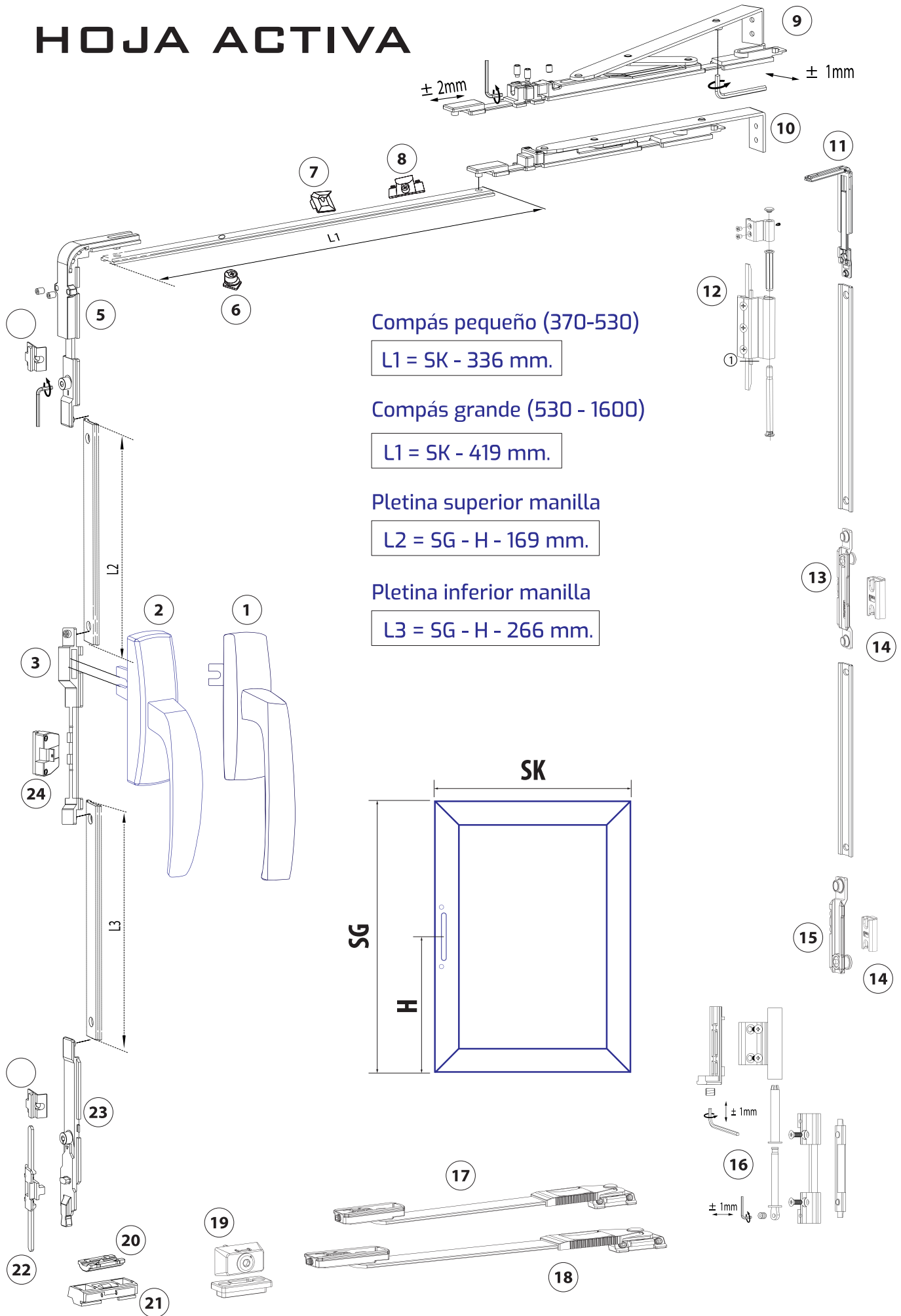

HOJA ACTIVA

NUMERO	REF.	DESCRIPCIÓN
1	Z0053	Manilla Yak con pala "U"
2	H1107	Manilla Cosmo con pala "U"
3	H1100	Conexión cremona Manilla Yak / Cosmo
4	H1100	Cerradero aluminio angulo reenvio
5	H1100	Ángulo reenvio O. B.
6	Z0059	Punto de cierre atornillable regulable
7	P1744	Cerradero aluminio marco C.E. 10 mm.
8	P1695	Cerradero ajustable C.E.
9	H1106	Compas Oscilo Batiente 530-1600 mm
10	H1105	Compas Oscilo Batiente 370-530 mm
11	H1108	Ángulo reenvio trasero
12	H1102	Bisagra hoja activa superior
13	Z0039	Punto cierre regulable intermedio de seguridad
14	Z0036	Cerradero punto cierre seguridad
15	Z0040	Punto cierre regulable final de seguridad
16	H1102	Bisagra hoja activa inferior
17	Z0019	Compás retenedor corto
18	Z0020	Compás retenedor largo
19	Z0028	Cerradura bloqueo de ventanas
20	H1100	Resbalón apoyo hoja
21	H1100	Cerradero de plastico inferior
22	H1100	Cerradero lateral puntero simple hoja
23	H1100	Pasador inferior
24	H1100	Falsa maniobra
	H1100	Kit base O.B. simple hoja (3, 4, 5, 20, 21, 22, 23, 24)

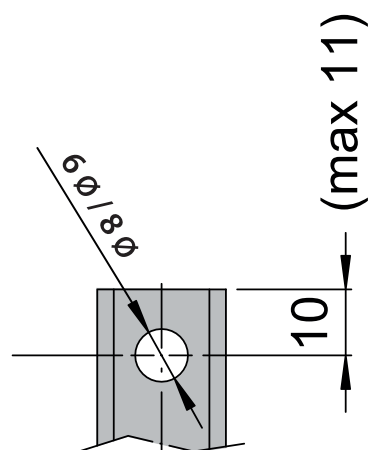
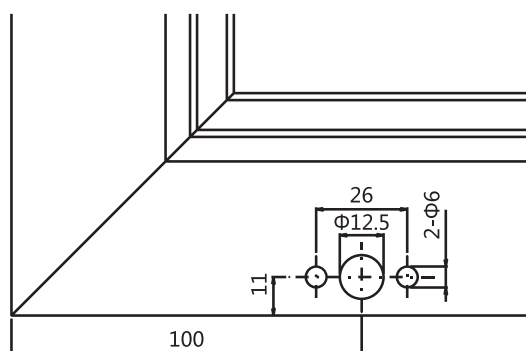

Galicube - Oscilo-Batiente C.E.

NUM.	DESCRIPCIÓN		REF.
2	KIT BASE S/H OB 1461I CUBE	50	96555
3	KIT BASE D/H OB 1462AI CUBE	50	96556
4	COMPAS 1447 CUBE V/364-700mm	10	30530
4	COMPAS 1447AI CUBE V/402-750mm	10	30531
4	COMPAS 1447BI CUBE V/560-1200mm	10	30532
4	COMPAS 1447CI CUBE V/680	10	30533
5	KIT BISAGRA 1410AI BLANCO 9016 CUBE	50	30534
5	KIT BISAGRA 1410AI NEGRO 9005 CUBE	50	30535
5	KIT BISAGRA 1410AI PLATA G6 CUBE	50	30536
5	KIT BISAGRA 1410AI L/INOX	50	30537
6	KIT BISAGRA 2ªHOJA 1414AI BLANCO 9016 OB CUBE	50	30540
6	KIT BISAGRA 2ªHOJA 1414AI NEGRO 9005 OB CUBE	50	30541
6	KIT BISAGRA 2ª HOJA 1414AI PLATA G6 OB CUBE	50	30542
6	KIT BISAGRA 2ª HOJA 1414AI L/INOX	50	30543
7	PASADOR G4 1500A CORTO	50	99640
8	PASADOR G4 1500B LARGO	50	99641
9	CERRAD. 4135A SIMPLE ZAMACK REG. GALICUBE	100	92908
10	ÁNGULO REENVÍO 1495	50	88519
11	ÁNGULO REENVÍO 1497A C/SUPLEM.	50	78837
12	COMPAS SUPLEMENTARIO 1455 V/1200-1700MM	10	88205

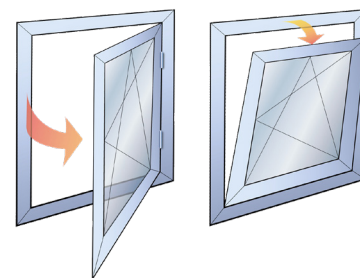

CREMONAS

NUM.	DESCRIPCIÓN		REF.
1	CREMONA 1P NEFER MIDI BLANCO 9016	50	95217
1	CREMONA 1P NEFER MIDI NEGRO 9005	50	95216
1	CREMONA 1P NEFER MIDI PLATA G6	50	95747
1	CREMONA 1P NEFER MIDI L/INOX	50	95951
1	CREMONA 1P GEA BLANCO 9016	50	94571
1	CREMONA 1P GEA NEGRO 9005	50	94573
1	CREMONA 1P GEA PLATA G6	50	94574
1	CREMONA 1P GEA L/INOX	50	94572

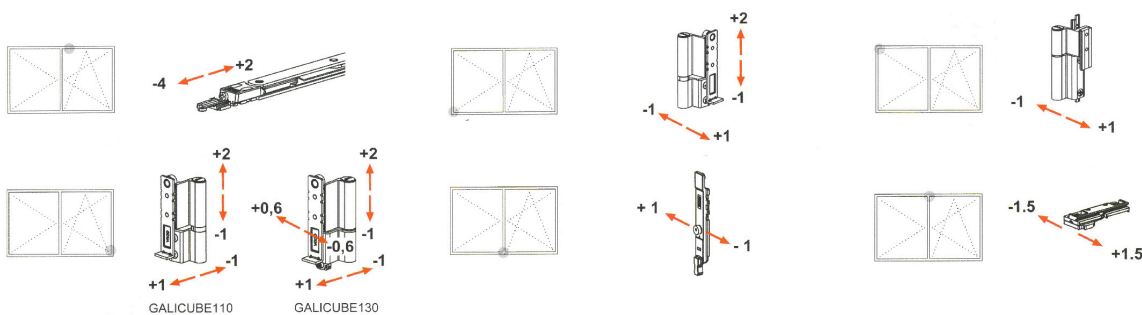
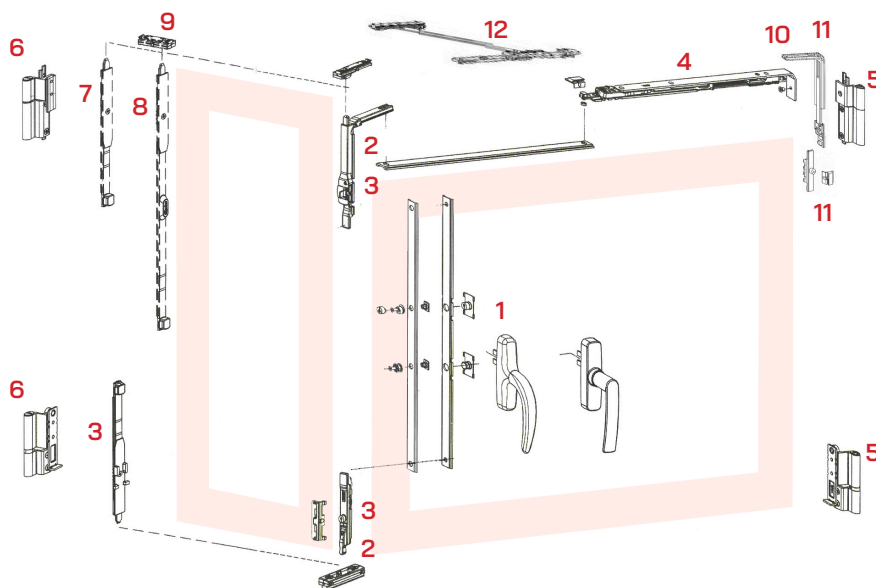

Galipus 2 - Oscilo-Batiente C.E.

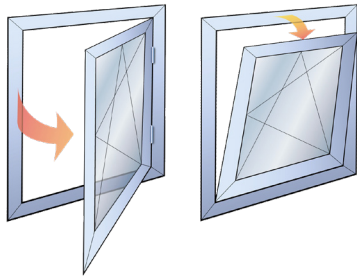

TIENDA



NÚM.	DESCRIPCIÓN	RAL			REF.
1	CREMONA 1 PALA NEFER	9016	-	50	95217
1	CREMONA 1 PALA NEFER	9005	-	50	95216
1	CREMONA 1 PALA NEFER	9006	-	50	95747
1	CREMONA 1 PALA NEFER	INOX	-	50	95951
2	KIT BASE S/H 1481I OB G2/G3	-	-	50	88277
3	KIT BASE D/H 1482AI OB G2/G3	-	-	50	88276
4	COMPÁS 1449	-	361 - 600mm	10	78674
4	COMPÁS 1449AI G2	-	402 - 705mm	10	78840
4	COMPÁS 1450AI	-	562 - 1200mm	10	78841
4	COMPÁS LARGO 1451 G2	-	816 - 1700mm	10	88037
5	KIT BISAGRA 1405I OB G2	9016	-	10	88809
5	KIT BISAGRA 1405I OB G2	9005	-	10	88279
5	KIT BISAGRA 1405I OB G2	9006	-	10	88882
5	KIT BISAGRA 1405I OB G2	INOX	-	10	99222
6	FALSO COMPÁS 1406	-	-	50	88814
7	ÁNGULO REENVÍO 1495	-	-	50	88519
8	ÁNGULO REENVÍO 1497A C/SUPLEM.	-	-	50	78837
9	COMPÁS SUPLEMENTARIO 1455	-	1200 - 1700mm	10	88205

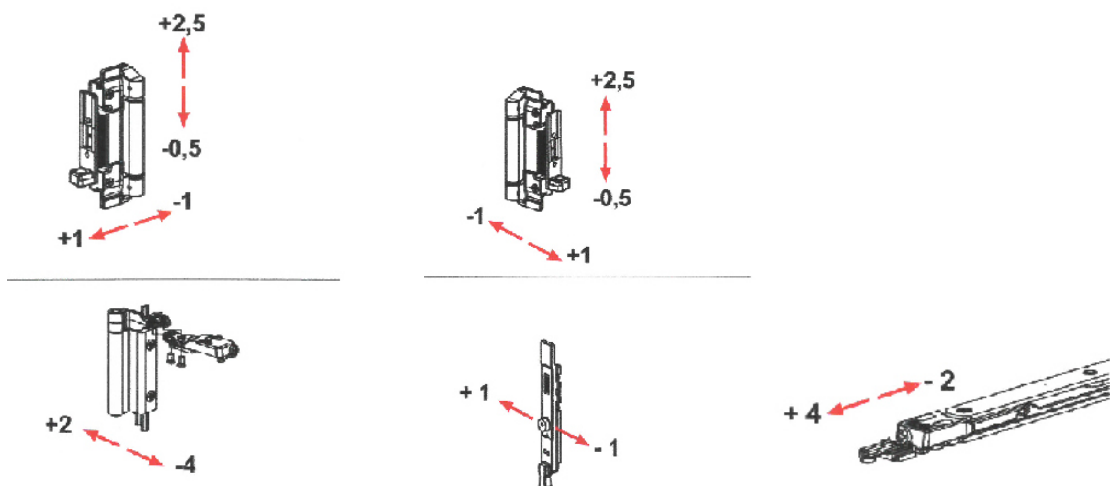
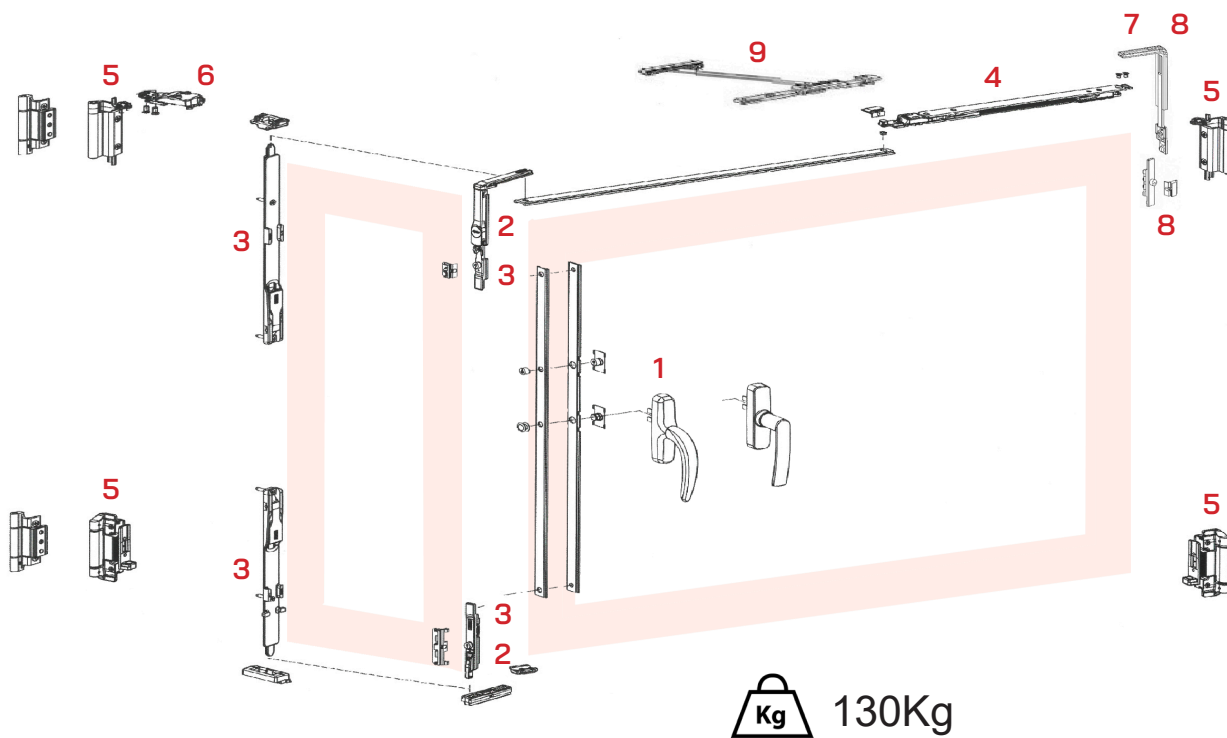

A close-up photograph of a metal hook or fastener, possibly a part of a suspension system. The hook is dark and metallic, with a curved shape. It is set against a background of diagonal stripes in shades of grey and black. The lighting is dramatic, highlighting the metallic texture and the curve of the hook.

SISTEMA SUPERPUESTO

LOTHUS

SISTEMA SUPERPUESTO "LOTHUS"

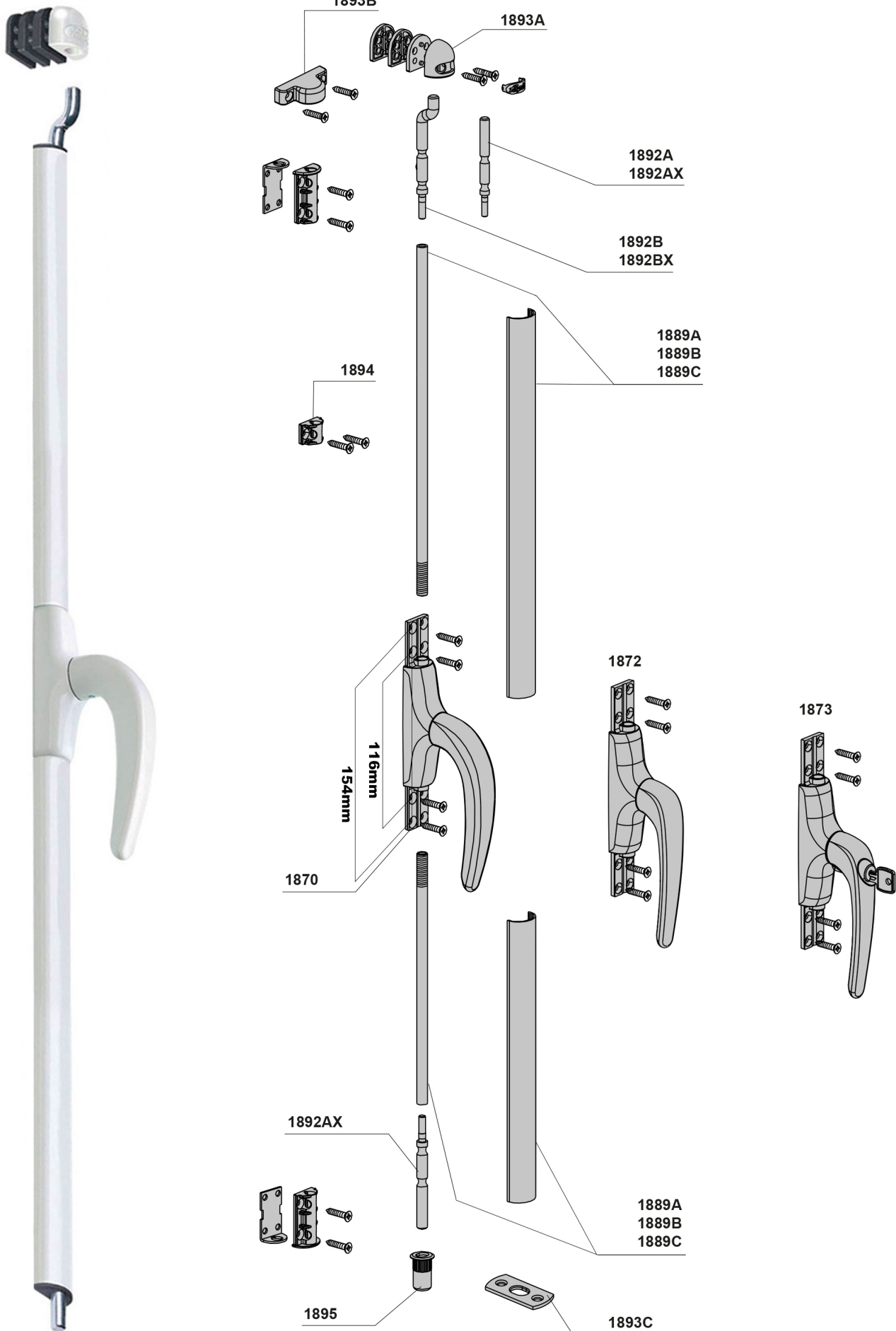

VA + CU 1889A / 1889B / 1889C

MODELO	Ø	AL	RAL	REF.
1889A	1.000mm	10	9016	98292
1889A	1.000mm	10	9005	98124
1889A	1.000mm	10	9006	98693
1889C	1.400mm	10	9016	98215
1889C	1.400mm	10	9005	98296
1889C	1.400mm	10	Inox	94742
1889C	1.400mm	10	9006	95024
1889B	1.800mm	10	9016	98294
1889B	1.800mm	10	9005	98216

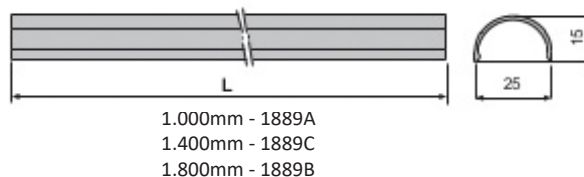

Cremona

MODELO	DESCRIPCIÓN	RAL	AL	REF.
1870	Cremona	9016	10	88856
1870	Cremona	9005	10	88188
1870	Cremona	9006	10	95034
1870	Cremona	Inox	10	88194
1872	Cremona fina	9016	10	98351
1872	Cremona fina	9005	10	98180
1872	Cremona fina	9006	10	98193
1872	Cremona fina c//lave	Inox	10	94271
1873	Cremona fina c//lave	9016	10	99112
1871	Cremona c//lave	9005	10	98235
1871	Cremona c//lave	9016	10	98421

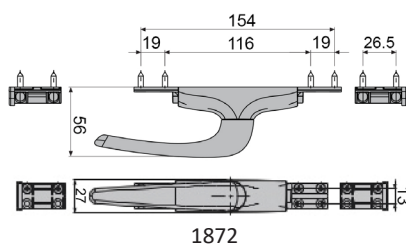
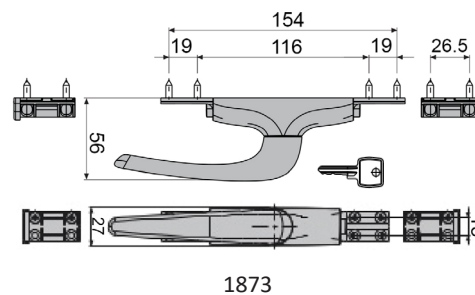
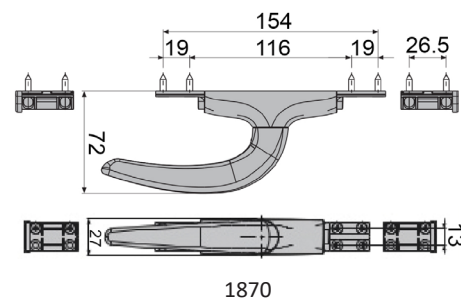

Cerradero y terminal

MODELO	DESCRIPCIÓN	RAL	AL	REF.
1893A	Cerradero superior	9016	10	88967
1893A	Cerradero superior	9005	10	88192
1893A	Cerradero superior	9006	10	95023
1893A	Cerradero superior	Inox	10	94763
1893B	Cerradero	9016	10	98629
1893B	Cerradero	9005	10	98626
1893C	Cerradero inferior	Inox	10	95292
88193	Pasante inter. nylon	9005	50	88193
1895	Cerradero inferior	Inox	10	88203
1892AX	Terminal inferior recto	Inox	10	88200
1892BX	Terminal inferior curvo	Inox	10	88201
1893A	Cerradero sup. especial	9005	10	88202

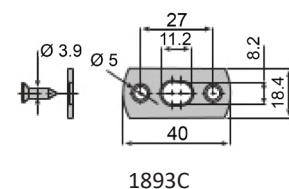
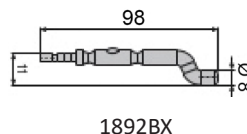
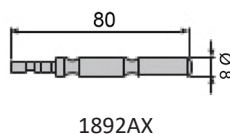
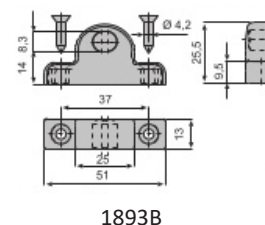
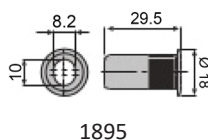
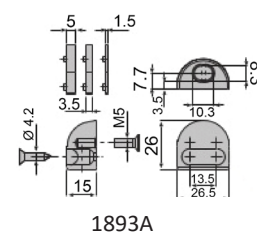
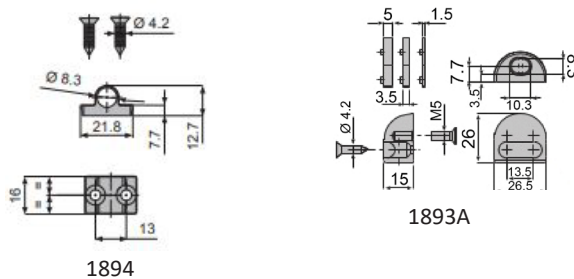

Bisagra pivotante 40x20

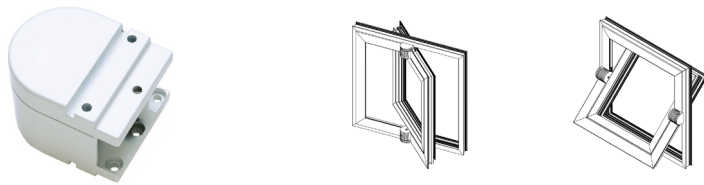

TIENDA



	RAL	REF.
1	9016	H3100-9016
1	9005	H3100-9005

Häusen®



J6002

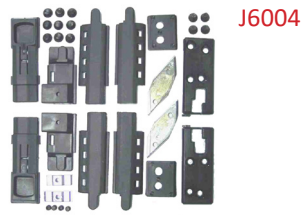

J6004

Kit cerraderos 40x20

TIENDA



HOJA		REF.
Simple	100	J6002
Doble	100	J6004

Häusen®

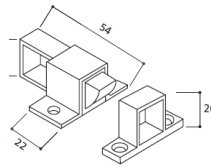

Cierre golpete tirador 40x20

TIENDA



RAL.		REF.
9016	100	J5001-9016
9005	100	J5001-9005



TIENDA

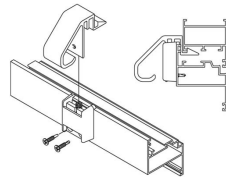

Cierre golpete multiserie 500 40x20

RAL.		REF.
9016	100	H7012-9016
9005	100	H7012-9005

Häusen®

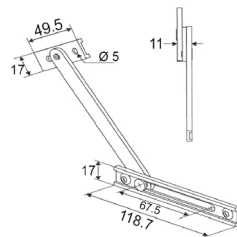

Bisagra compás 40x20

TIENDA



RAL.		REF.
9016	100	J5109-9016
9005	100	J5109-9005

Häusen®

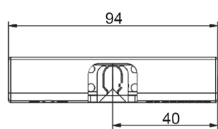

TIENDA



Clip de retención 40x20

			MEDIDAS	REF.
9mm	100	18,02	250x150x115	P3110
13mm	100	18,02	250x150x115	P3111

Häusen®

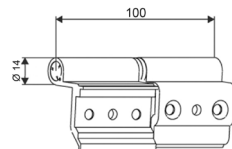

TIENDA



Bisagra 40x20

RAL	MANO		REF.
9016	Izquierda	100	J51001-9016
9005	Izquierda	100	J51001-9005
9016	Derecha	100	J5100D-9016
9005	Derecha	100	J5100D-9005

Bisagra 3 cuerpos 40x20

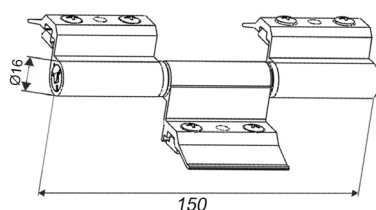





TIENDA



RAL.		REF.
9016	100	J5107-9016
9005	100	J5107-9005





Pasadores puente alto

DESCRIPCIÓN					REF.
PASADOR PUENTE ALTO	30	0,3	45 MM	BLANCO	98932
PASADOR PUENTE ALTO	30	0,3	45 MM	NEGRO	98933
PASADOR PUENTE ALTO	25	0,5	100 MM	BLANCO	92503
PASADOR PUENTE ALTO	25	0,5	100 MM	NEGRO	92504
PASADOR PUENTE ALTO	25	0,5	100 MM	PLATA	94366
PASADOR PUENTE ALTO	15	0,8	150 MM	BLANCO	99093
PASADOR PUENTE ALTO	15	0,8	150 MM	NEGRO	99445
PASADOR PUENTE ALTO	10	0,9	200 MM	BLANCO	98934
PASADOR PUENTE ALTO	10	0,9	200 MM	NEGRO	98935
PASADOR PUENTE ALTO	10	1,0	250 MM	BLANCO	94630
PASADOR PUENTE ALTO	10	1,0	250 MM	NEGRO	94767
PASADOR PUENTE ALTO	10	1,2	300 MM	BLANCO	98936
PASADOR PUENTE ALTO	10	1,2	300 MM	NEGRO	98937
PASADOR PUENTE ALTO	10	1,2	400 MM	BLANCO	96567
PASADOR PUENTE ALTO	10	1,2	400 MM	NEGRO	94133
PASADOR PUENTE ALTO	10	1,5	500 MM	BLANCO	96568
PASADOR PUENTE ALTO	10	1,5	500 MM	NEGRO	92988
PASADOR PUENTE GRUESO	25	0,8	100 MM	BLANCO	96569
PASADOR PUENTE GRUESO	25	0,8	100 MM	NEGRO	96570
PASADOR PUENTE GRUESO	15	1,0	150 MM	BLANCO	99094
PASADOR PUENTE GRUESO	15	1,0	150 MM	NEGRO	92978
PASADOR PUENTE GRUESO	10	1,2	250 MM	BLANCO	96571
PASADOR PUENTE GRUESO	10	1,2	250 MM	NEGRO	96572
PASADOR PUENTE GRUESO	10	1,6	500 MM	BLANCO	94132
PASADOR PUENTE GRUESO	10	1,6	500 MM	NEGRO	96573

TIENDA

PASADOR
PUENTE ALTOPASADOR
PUENTE GRUESO

Pasadores de puente alto EJE INOX

DESCRIPCIÓN					REF.
PASADOR PUENTE ALTO INOX	25	0,3	100 MM	BLANCO	H9110-9016
PASADOR PUENTE ALTO INOX	25	0,3	100 MM	NEGRO	H9110-9005
PASADOR PUENTE ALTO INOX	15	0,5	150 MM	BLANCO	H9111-9016
PASADOR PUENTE ALTO INOX	15	0,5	150 MM	NEGRO	H9111-9005
PASADOR PUENTE ALTO INOX	10	0,5	250 MM	BLANCO	H9112-9016
PASADOR PUENTE ALTO INOX	10	0,8	250 MM	NEGRO	H9112-9005
PASADOR PUENTE ALTO INOX	10	0,8	300 MM	BLANCO	H9113-9016
PASADOR PUENTE ALTO INOX	10	0,9	300 MM	NEGRO	H9113-9005
PASADOR PUENTE ALTO INOX	10	0,9	500 MM	BLANCO	H9114-9016
PASADOR PUENTE ALTO INOX	10	1,0	500 MM	NEGRO	H9114-9005
PASADOR PUENTE GRUESO INOX	25	0,3	100 MM	BLANCO	H9100-9016
PASADOR PUENTE GRUESO INOX	25	0,3	100 MM	NEGRO	H9100-9005
PASADOR PUENTE GRUESO INOX	15	0,5	150 MM	BLANCO	H9101-9016
PASADOR PUENTE GRUESO INOX	15	0,5	150 MM	NEGRO	H9101-9005
PASADOR PUENTE GRUESO INOX	10	0,5	250 MM	BLANCO	H9102-9016
PASADOR PUENTE GRUESO INOX	10	0,8	250 MM	NEGRO	H9102-9005
PASADOR PUENTE GRUESO INOX	10	0,8	350 MM	BLANCO	H9103-9016
PASADOR PUENTE GRUESO INOX	10	0,9	350 MM	NEGRO	H9103-9005
PASADOR PUENTE GRUESO INOX	10	0,9	500 MM	BLANCO	H9104-9016
PASADOR PUENTE GRUESO INOX	10	1,0	500 MM	NEGRO	H9104-9005

TIENDA

PASADOR
PUENTE ALTOPASADOR
PUENTE GRUESO



TIENDA



Pasadores



PASADOR DE APOYO

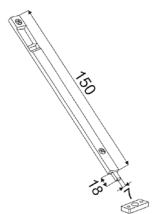

PASADOR TITÁN

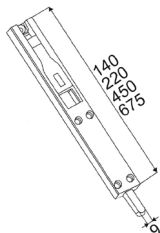

PASADOR TITANDUE

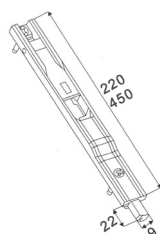

PASADOR ATLAS

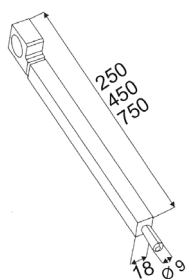

PASADOR ATLAS CON LLAVE

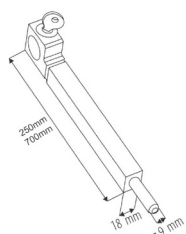

DESCRIPCIÓN					REF.
PASADOR APOYO 3712	50	1,9	150 MM	BLANCO	78861
PASADOR APOYO 3712	50	1,9	150 MM	NEGRO	78937
PASADOR APOYO 3713	20	4,5	440 MM	NEGRO	92309
PASADOR TITÁN 3714	20	3,3	140 MM	BLANCO	98245
PASADOR TITÁN 3714	20	3,3	140 MM	NEGRO	88226
PASADOR TITÁN 3715	20	4,0	220 MM	BLANCO	88912
PASADOR TITÁN 3715	20	4,0	220 MM	NEGRO	78889
PASADOR TITÁN 3715	20	4,0	220 MM	PLATA	95458
PASADOR TITÁN 3716	20	6,6	450 MM	BLANCO	99018
PASADOR TITÁN 3716	20	6,6	450 MM	NEGRO	78888
PASADOR TITÁN 3716	20	6,6	450 MM	PLATA	96304
PASADOR TITÁN 3717	10	9,5	675 MM	BLANCO	98696
PASADOR TITÁN 3717	10	9,5	675 MM	NEGRO	88227
PASADOR TITÁN 3717	10	9,5	675 MM	PLATA	95672
PASADOR TITANDUE 3720B	20	3,0	220MM	NEGRO	99175
PASADOR TITANDUE 3720B	20	3,0	220MM	PLATA	99182
PASADOR TITANDUE 3720C	20	3,0	220 MM	BLANCO	78854
PASADOR TITANDUE 3720C	20	3,0	220 MM	NEGRO	78855
PASADOR TITANDUE 3722B	10	4,0	220 MM	BLANCO	88854
PASADOR TITANDUE 3722B	10	4,0	220 MM	NEGRO	88608
PASADOR TITANDUE 3721B	20	4,5	450 MM	NEGRO	63436
PASADOR TITANDUE 3721B	20	4,5	450 MM	PLATA	63437
PASADOR TITANDUE 3721C	20	4,5	450 MM	BLANCO	98628
PASADOR TITANDUE 3721C	20	4,5	450 MM	NEGRO	88031
PASADOR ATLAS 3723	10	2,5	250 MM	BLANCO	88911
PASADOR ATLAS 3723	10	2,5	250 MM	NEGRO	78866
PASADOR ATLAS 3723	10	2,5	250 MM	PLATA	99224
PASADOR ATLAS 3724	10	4,4	450 MM	BLANCO	98246
PASADOR ATLAS 3724	10	4,4	450 MM	NEGRO	78981
PASADOR ATLAS 3724	10	4,4	450 MM	PLATA	96302
PASADOR ATLAS 3725	10	6,6	700 MM	BLANCO	78868
PASADOR ATLAS 3725	10	6,6	700 MM	NEGRO	88557
PASADOR ATLAS C/LLAVE 3726	10	2,9	250 MM	BLANCO	78869
PASADOR ATLAS C/LLAVE 3726	10	2,9	250 MM	NEGRO	88547
PASADOR ATLAS C/LLAVE 3727	10	4,9	450 MM	BLANCO	78870
PASADOR ATLAS C/LLAVE 3727	10	4,9	450 MM	NEGRO	99019
PASADOR ATLAS C/LLAVE 3727	10	4,9	450 MM	ANODIZ.	88548
PASADOR ATLAS C/LLAVE 3728	10	9,0	700 MM	ANODIZ.	78871



TIENDA



Cerradero pasador Atlas 3740

				REF.
10	0,3	PLATA	95459	
10	0,3	BLANCO	98264	

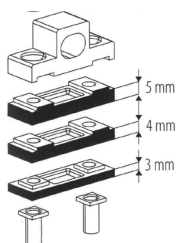

Cerradero superior Titan zamak 3733

TIENDA





			REF.
100	2,00	78872	



Cerradero inferior Titan inox 3735A

fapim

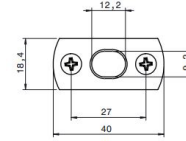

		REF.
100	2,00	85233

TIENDA



Cerradero 3738 inferior Atlas/Titán

fapim

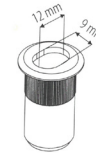
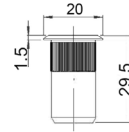

		REF.
20	0,30	78833

TIENDA



Cerradero inferior con tapa

fapim

A	B			REF.
9,8	6	20	0,3	85280
11,7	8	20	0,3	85281
13,5	9	20	0,3	85282
13,7	10	20	0,3	85283
16	12	20	0,3	85266
16	13	20	0,3	85285
18	14	20	0,3	85284

TIENDA

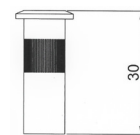
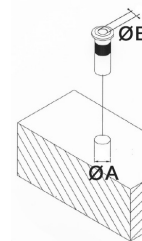

Kit cerraderos C.E. SH c/microventilación

Häusen

	REF.
10	H7021

TIENDA



Kit cerraderos C.E. DH c/microventilación

Häusen

	REF.
5	H7022

TIENDA

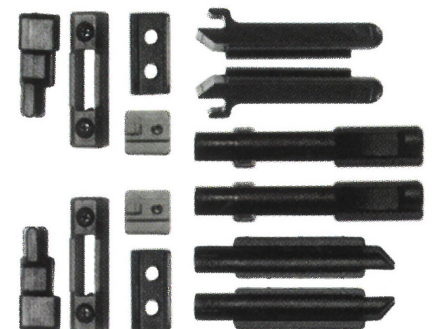

Kit cerraderos C.E. simple hoja

Häusen

	REF.
50	H7010

TIENDA

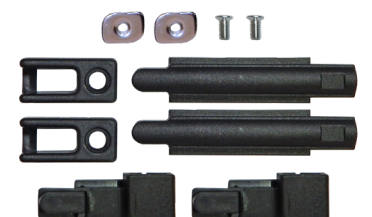

Empalme cremona nylon C.E.

fapim

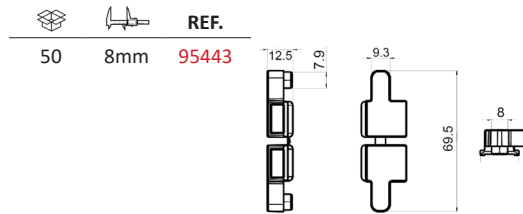

TIENDA



Zenit resbalón apoyo hoja + cerradero inferior

ZENIT

DESCRIPCIÓN	UDS:	 Kg	REF:
Zenit resbalón apoyo hoja	500	1,80	Z0016
Zenit cerradero de plástico inferior	500	4,30	Z0024

TIENDA

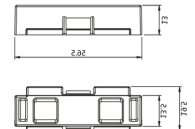

Kit resbalón + apoyo hoja

ZENIT

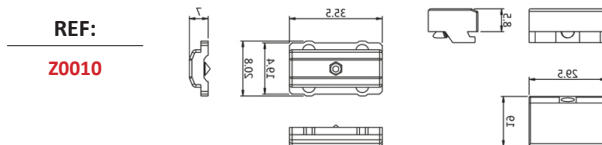





TIENDA



Pasador leva 140mm

Häusen



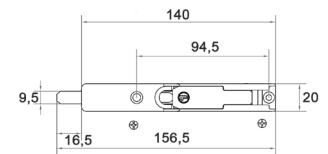

Icono	RAL	Icono	REF.
	9016		140mm H6044-9016
	9005		140mm H6044-9005

TIENDA



Pasador leva 218mm

Häusen

Icono	RAL	Icono	REF.
	9016		218mm H6045-9016
	9005		218mm H6045-9005

TIENDA

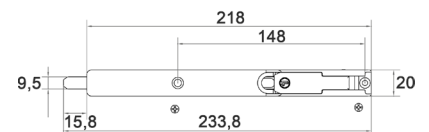

Block - Kit pasadores leva 2ª hoja

ZENIT

Icono	Icono	 Kg	REF:
		20	280 x 255 x 110
		8,20	ZK001



1.000 horas de lluvia salina certificadas



TIENDA

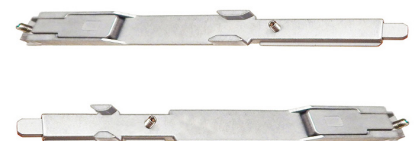

ZENIT



1.000 horas de lluvia salina certificadas

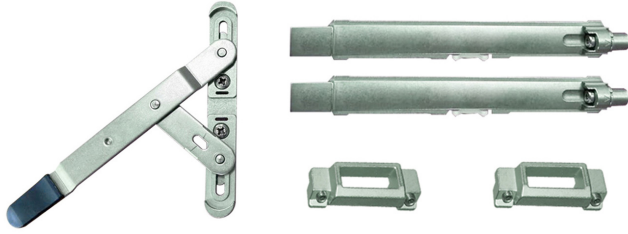

Lance - Pasadores palanca bidireccionales

Icono	REF:
20	Z0041

TIENDA



fapim

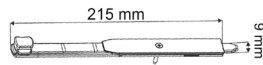
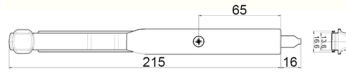

Pasador corto G4 1500A

Icono	Icono	Icono	REF.
10	1,40	215mm	99640

TIENDA



fapim

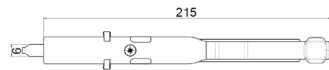

Pasador inf. largo + pestañas 1504B

Icono	Icono	Icono	REF.
50	4,90	215mm	94372

TIENDA



fapim

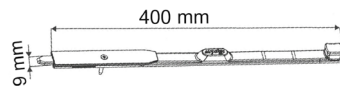
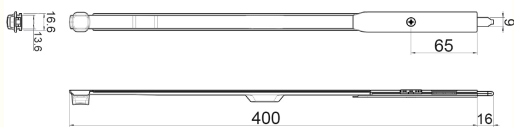

Pasador largo G4 1500B

Icono	Icono	Icono	REF.
50	4,40	400mm	99641

TIENDA



ZENIT



ZK004



ZK024

Kit reenvío + p/cierre final + cerradero C.E.

DESCRIPCIÓN	Icono	REF:
Kit reenvío + p/cierre final estándar + cerradero	50	ZK004
Kit reenvío + p/cierre final seguridad + cerradero	50	ZK024



1.000 horas de lluvia salina certificadas

TIENDA



Kit reenvío + p/cierre intermedio + cerradero C.E.

ZENIT

DESCRIPCIÓN	UDS:	REF:
Kit reenvío + 2 p/cierre estándar + 2 cerraderos	50	ZK005
Kit reenvío + 2 p/cierre seguridad + 2 cerraderos	50	ZK025



1.000 horas de lluvia salina certificadas

TIENDA



ZK005



ZK025

Ángulo reenvío C.E.

ZENIT

UDS:	DESCRIPCIÓN	UDS:	REF:
50	320 x 240 x 160	19,90	Z0023



1.000 horas de lluvia salina certificadas

TIENDA



Kit punto cierre final C.E.

ZENIT

DESCRIPCIÓN	UDS:	REF:
Kit punto cierre final std. + cerradero	50	ZK002
Kit punto cierre final seg. + cerradero	50	ZK021



1.000 horas de lluvia salina certificadas

TIENDA



ZK002



ZK021

Kit punto cierre intermedio C.E.

ZENIT

DESCRIPCIÓN	UDS:	REF:
Kit punto cierre intermedio std. + cerradero	50	ZK003
Kit punto cierre intermedio seg. + cerradero	50	ZK022



1.000 horas de lluvia salina certificadas

TIENDA



ZK003



ZK022

Kit punto de cierre regulable pasante **estándar** C.E.

ZENIT

DESCRIPCIÓN	UDS:	REF:
Kit punto cierre reg. pasante	50	ZK038



1.000 horas de lluvia salina certificadas

TIENDA

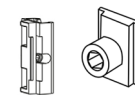

Kit punto de cierre regulable pasante **seguridad** C.E.

ZENIT

DESCRIPCIÓN	UDS:	REF:
Kit punto cierre reg. pasante seg.	50	ZK037



1.000 horas de lluvia salina certificadas

TIENDA

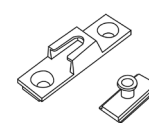

ZENIT



1.000 horas de lluvia salina certificadas

Cerradero pasadores leva 2ª hoja C.E.

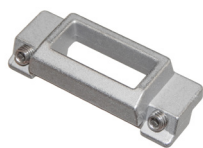

TIENDA

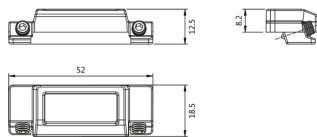

POSICIÓN	REF.
Sup. / Inf.	Z0013

Häusen®



TIENDA



Cerradero simple hoja montado C.E.

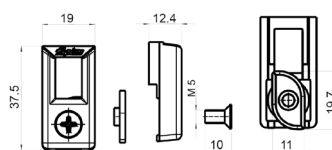

		REF.
30	2,00	H7025

Häusen®



TIENDA



Cerradero doble hoja montado C.E.

		REF.
50	2,00	H7026

Häusen®



TIENDA



Cerradero doble regulable zamak C.E.

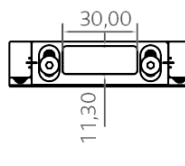

		REF.
100	4,00	H7027



fapim®

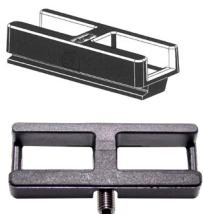

TIENDA



Cerradero doble 4100 nylon C.E.

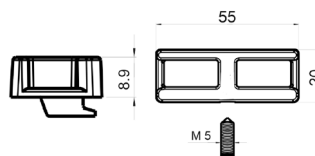

		REF.
100	1,00	88546

fapim®



TIENDA



Cerradero doble 4115 nylon C.E.

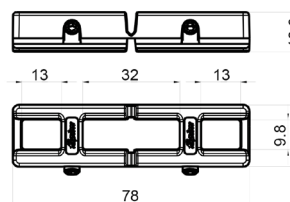

		REF.
100	1,00	95447

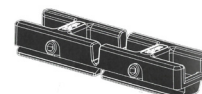

fapim®



TIENDA



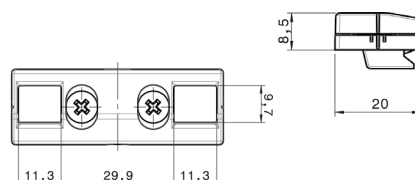

Cerradero simple 4135A reg. zamak



		REF.
50	2,80	92908

Cerradero inferior hoja pasiva

fapim

		REF.
50	2,30	88600

TIENDA

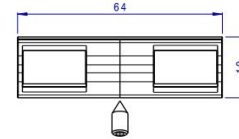
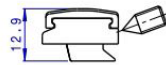

Cerradero simple 4134 zamak

fapim

		REF.
100	2,60	88607

TIENDA

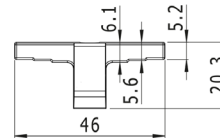
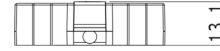

Cuna empalme cremona 1559A nylon

fapim

		REF.
50	2,40	96563

TIENDA

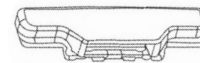
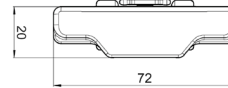

Cuna empalme cremona 1559 zamak

fapim

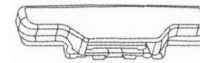
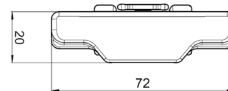

		REF.
50	4,50	88280

TIENDA



Punto de cierre rebatir atornillado

fapim

		REF.
50	0,30	94746

TIENDA

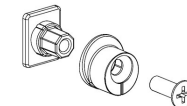
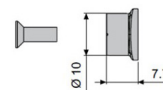

Punto de cierre atornillado regulable

Häusen



	REF.
50	P1696

TIENDA



Perno empalme cremona remachado 1565I

fapim

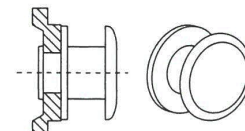
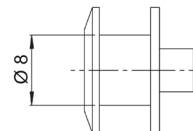

		REF.
100	0,60	78849

TIENDA



Punto de cierre clipado regulable 1593I

fapim

		REF.
100	1,10	99638

TIENDA

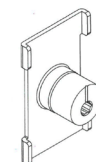
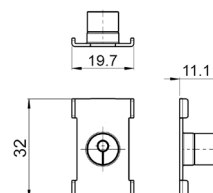

fapim

Perno empalme cremona clipado inox 15631

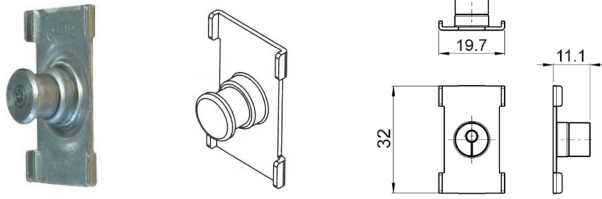

		REF.
100	1,10	99637

TIENDA



Häusen

Clip de retención C.E.

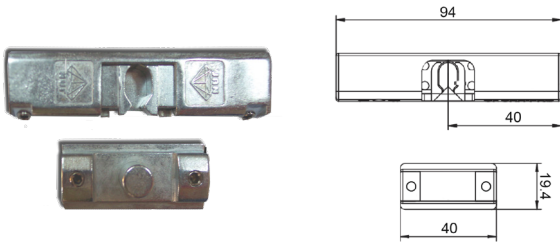

	REF.
100	J5024

TIENDA



fapim

Clip retenedor c/pestillo 1620



		REF.
50	1,90	88949

TIENDA



fapim

Microventilación 1618

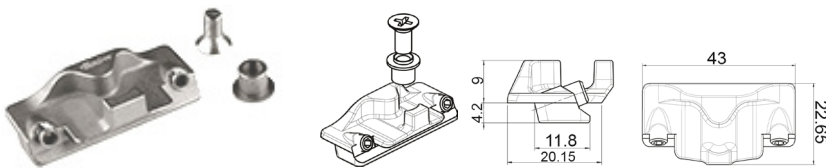

		REF.
50	1,80	99616

TIENDA



Häusen

Cerradero aluminio ajustable C.E.

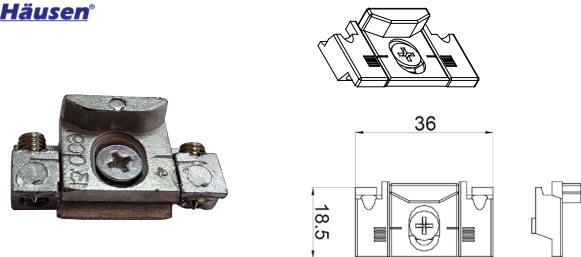

		REF.
100	1,10	P1695

TIENDA



Häusen

Cerradero aluminio universal 10mm C.E.

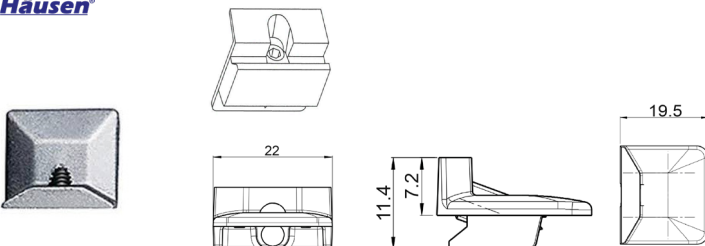

		REF.
1.000	5,00	P1744

TIENDA



Häusen

Cerradero inferior aluminio Canal-16

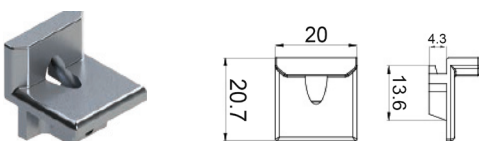

			REF.
100	5,00	9mm	P1743
100	5,00	13mm	P1722

TIENDA



Kit de ventanas francesas 1679



		REF.
50	6,70	78838

TIENDA

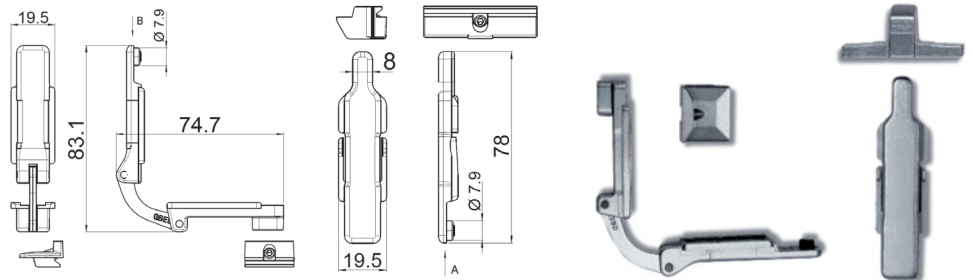

Bisagra pivotante C.E.

	RAL	REF.
1	9016	H3101-9016
1	9005	H3101-9005

TIENDA

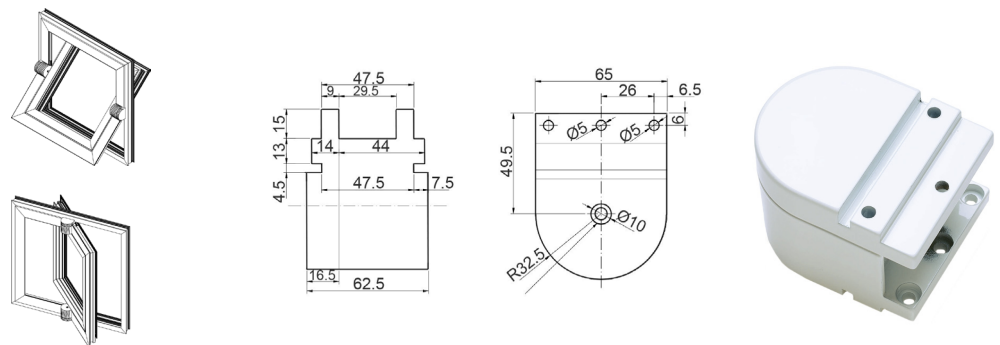

Bisagra pivotante S/2300 C.E.

	RAL	REF.
1	9016	H3102-9016
1	9005	H3102-9005

TIENDA

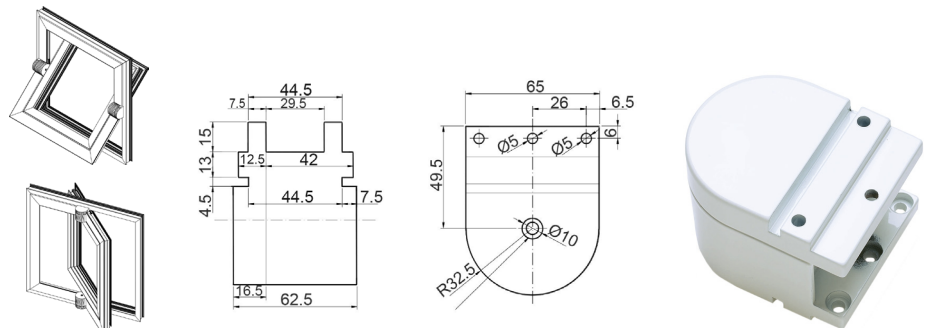

Tapones para cierre tándem/golpete

		RAL	Ø		REF.
20	3,00	9016	17mm	15mm	85270
20	3,00	9005	17mm	15mm	85274
20	3,00	9006	17mm	15mm	85275

TIENDA



Cierre golpete C.E.

		RAL	REF.
50	6,10	9016	H7015-9016
50	6,10	9005	H7015-9005

TIENDA

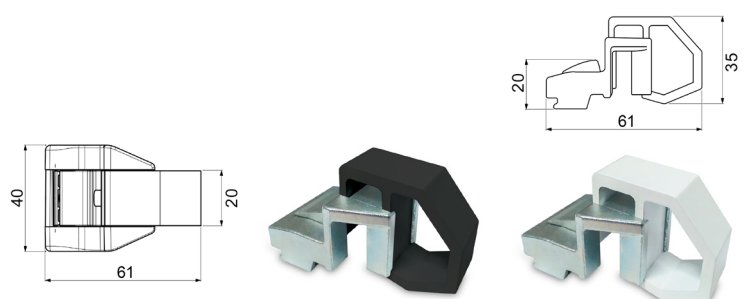

Häusen

Bisagra compás 150/220 mm

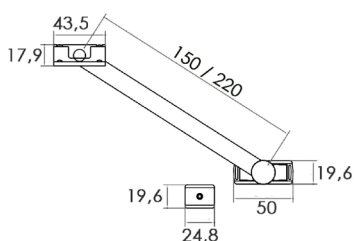

		REF.
50	4,9	H7033
50	5,5	H7034

TIENDA



ZENIT

Compás retenedor corto inox 250mm
Acero inoxidable SS304, para hojas de tamaño desde 445mm



				REF:
100	250mm	360 x 280 x 180	13,00	Z0019

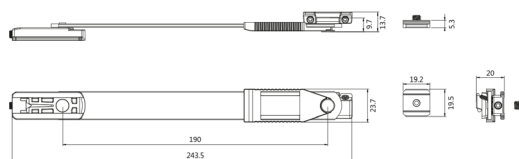

1.000 horas de lluvia salina certificadas

TIENDA



ZENIT

Compás retenedor largo inox 300mm
Acero inoxidable SS304, para hojas de tamaño desde 445mm



				REF:
100	300mm	360 x 280 x 180	13,00	Z0020

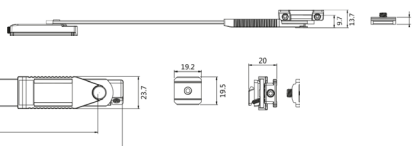

1.000 horas de lluvia salina certificadas

TIENDA



ZENIT

Raptor - Compás retenedor automático



UDS:	REF:
20	Z0027



1.000 horas de lluvia salina certificadas





Demostración

TIENDA



Venice Baby - Bisagra

		RAL	REF.
20	4,90	9016	99017
20	4,90	9005	98901
20	4,90	INOX	99480

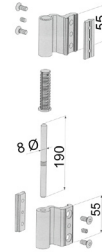
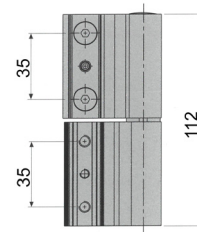
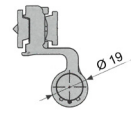

TIENDA



fapim



Venice Baby - Bisagra 3ª hoja

		RAL	REF.
20	4,50	9016	99322
20	4,50	9005	99575
20	4,50	INOX	92980

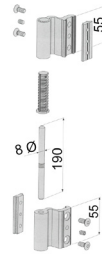
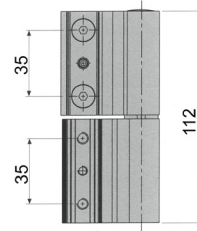
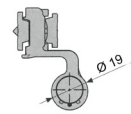

TIENDA



fapim



Venice Baby - Bisagra 4ª hoja

		RAL	REF.
20	6,00	9016	99330
20	6,00	9005	99405
20	6,00	INOX	92981

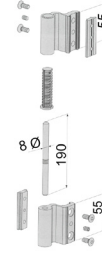
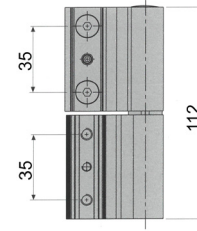
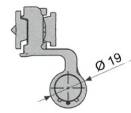

TIENDA



fapim



Venice - Bisagra 3 cuerpos

		RAL	REF.
12	7,30	9016	99282
12	7,30	9005	99283
12	7,30	INOX	92534

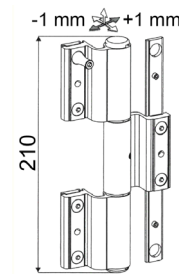
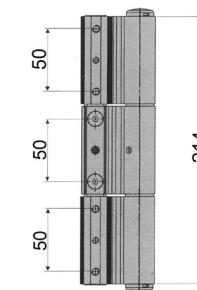
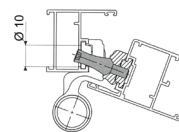

TIENDA



fapim



Tornillo especial antirobo para bisagras Venice

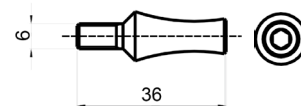

		REF.
50	1,30	88614

TIENDA



fapim

Espina de seguridad acero inox

		REF.
50	1,90	88490

TIENDA

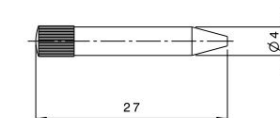

fapim

fpim

Grip - Bisagra

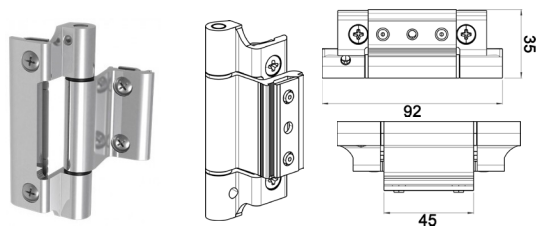

TIENDA



	RAL	REF.
50	9016	88811
50	9005	78678
50	INOX	98370

Häusen

Bisagra 3 cuerpos C.E.

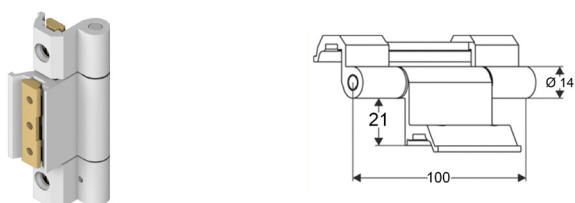

TIENDA



	RAL	REF.
100	9016	J5101-9016
100	9005	J5101-9005

Häusen

Gamma - Bisagra 2 cuerpos C.E.

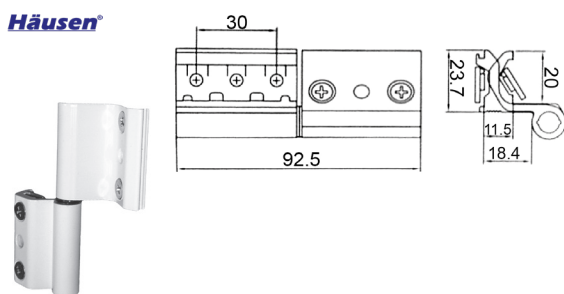

TIENDA



	RAL	MANO	REF.
100	9016	Izqu.	H4108I-9016
100	9016	Dcha.	H4108D-9016
100	9005	Izqu.	H4108I-9005
100	9005	Dcha.	H4108D-9005



Gamma - Bisagra 3 cuerpos C.E.

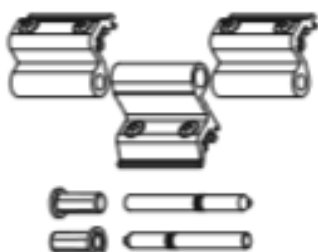

TIENDA



	RAL	REF.
10	9016	94057
10	9005	94034



Betta - Bisagra 2 cuerpos C.E.

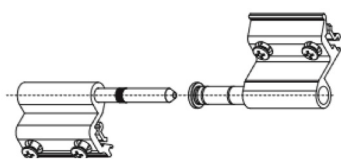

TIENDA



	RAL	REF.
50	9016	H4115-9016
50	9005	H4115-9005



Betta - Bisagra 3 cuerpos C.E.

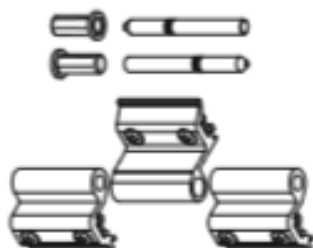



TIENDA



	RAL	REF.
50	9016	H4118-9016
50	9005	H4118-9005



Alfa - Bisagra de puerta C.E.

Pletina inox premontada

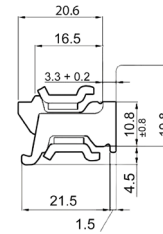
		RAL	MANO	REF.
50	6,00	9016	Izqu.	H4050I-9016
50	6,00	9016	Dcha.	H4050D-9016
50	6,00	9005	Izqu.	H4050I-9005
50	6,00	9005	Dcha.	H4050D-9005



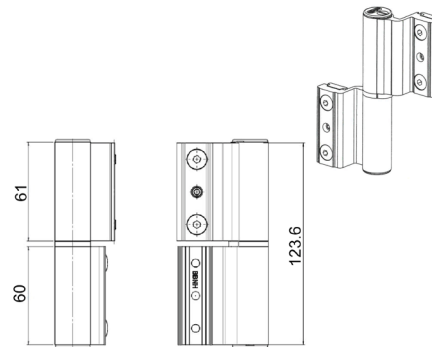

Monza - Bisagra de puerta

		RAL	REF.
20	6,10	9016	96554
20	6,10	9005	92928
20	6,10	9006	94783



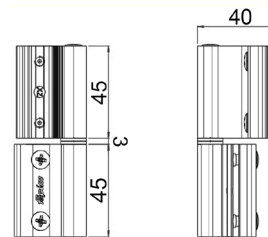

Blitz - Bisagra

		RAL	REF.
50	5,20	9016	88772
50	5,20	9005	78901
50	5,20	9006	88765
50	5,20	INOX	94246



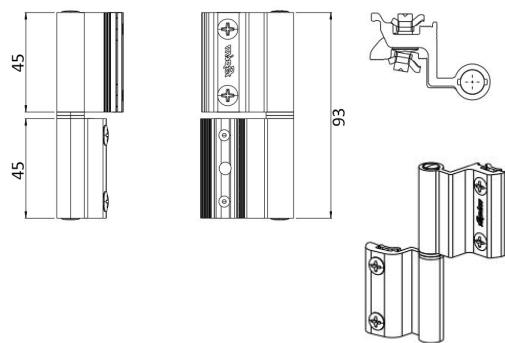

Blitz - Bisagra para 3ª hoja

		RAL	REF.
50	5,20	9016	98127
50	5,20	9005	88355
50	5,20	INOX	98712



Casquillo excéntrico 9799 para bisagras Blitz

		REF.
100	0,30	78902

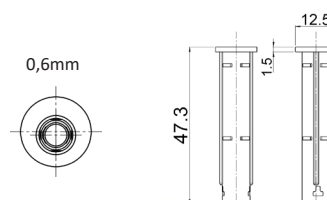



Loira - Bisagra de puerta 2 cuerpos



TIENDA



DESCRIPCIÓN	A (mm)	B (mm)	I (mm)			RAL	REF.
Bisagra Loira 7000V	20,5	39,5	60	12	4,20	9016	94606
Bisagra Loira 7000V	20,5	39,5	60	12	4,20	9005	96118
Bisagra Loira 7010V	20,5	46,5	67	12	4,30	9016	92827
Bisagra Loira 7010V	20,5	46,5	67	12	4,30	9005	96120
Bisagra Loira 7020V	39,5	39,5	79	12	4,60	9016	85286
Bisagra Loira 7020V	39,5	39,5	79	12	4,60	9005	85245
Bisagra Loira 7030V	20,5	59,5	80	12	4,60	9016	85287
Bisagra Loira 7030V	20,5	59,5	80	12	4,60	9005	85288
Bisagra Loira 7040V	39,5	46,5	86	12	4,70	9016	85289
Bisagra Loira 7040V	39,5	46,5	86	12	4,70	9005	85290
Bisagra Loira 7050V	46,5	46,5	93	12	4,90	9016	85291
Bisagra Loira 7050V	46,5	46,5	93	12	4,90	9005	94784
Bisagra Loira 7060V	39,5	59,5	99	12	5,00	9016	85292
Bisagra Loira 7060V	39,5	59,5	99	12	5,00	9005	85293
Bisagra Loira 7070V	46,5	59,5	106	12	5,20	9016	85294
Bisagra Loira 7070V	46,5	59,5	106	12	5,20	9005	85295

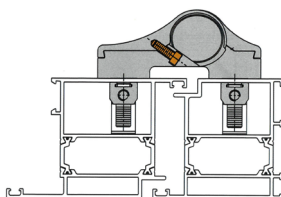
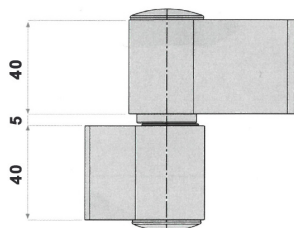
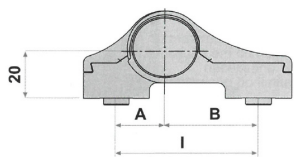

-2.5 mm +2.5 mm

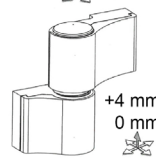

-0.5 mm +0.5 mm



Loira - Bisagra de puerta 3 cuerpos



TIENDA



DESCRIPCIÓN	A (mm)	B (mm)	I (mm)			RAL	REF.
Bisagra Loira 7003V	20,5	39,5	60	12	5,20	9016	86000
Bisagra Loira 7003V	20,5	39,5	60	12	5,20	9005	86001
Bisagra Loira 7013V	20,5	46,5	67	12	5,30	9016	86002
Bisagra Loira 7013V	20,5	46,5	67	12	5,30	9005	86003
Bisagra Loira 7023V	39,5	39,5	79	12	5,60	9016	85246
Bisagra Loira 7023V	39,5	39,5	79	12	5,60	9005	92913
Bisagra Loira 7033V	20,5	59,5	80	12	5,60	9016	86004
Bisagra Loira 7033V	20,5	59,5	80	12	5,60	9005	86005
Bisagra Loira 7043V	39,5	46,5	86	12	5,70	9016	86006
Bisagra Loira 7043V	39,5	46,5	86	12	5,70	9005	86007
Bisagra Loira 7053V	46,5	46,5	93	12	5,90	9016	86008
Bisagra Loira 7053V	46,5	46,5	93	12	5,90	9005	86009
Bisagra Loira 7063V	39,5	59,5	99	12	6,00	9016	86010
Bisagra Loira 7063V	39,5	59,5	99	12	6,00	9005	86011
Bisagra Loira 7073V	46,5	59,5	106	12	6,20	9016	86012
Bisagra Loira 7073V	46,5	59,5	106	12	6,20	9005	86013

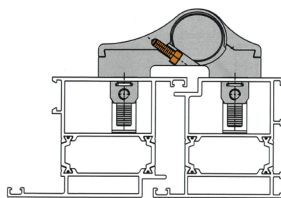
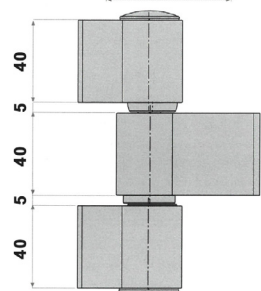
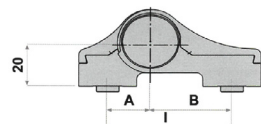

-2.5 mm +2.5 mm

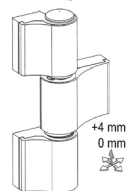

-0.5 mm +0.5 mm

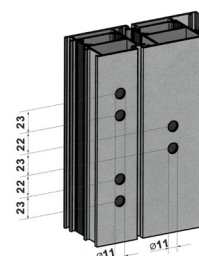

Kit fijación Loira - Kit fijación bisagra Loira 2 cuerpos

fapim

	REF.
1	94506

TIENDA

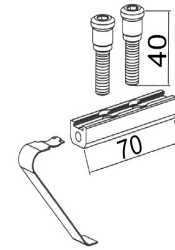

Kit fijación Loira - Kit fijación bisagra Loira 3 cuerpos

fapim

	REF.
1	85247

TIENDA

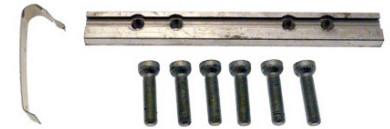
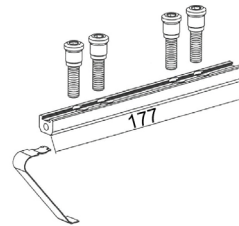

Plantilla Loira - Plantilla fijación bisagra Loira

fapim

	REF.
1	98166

TIENDA



Pletina falleba C.E. de fibra de vidrio

	REF.
250 metros	H7045

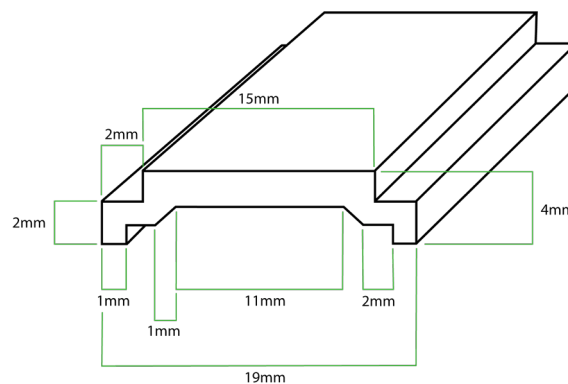

TIENDA



PARA MAS INFORMACIÓN DESCARGUE
NUESTRO CATÁLOGO ESPECIAL DE:

CORREDERA Y PROYECTANTE



Descargue el
catálogo completo



Cerradero corredera Kömmerling / Profine.

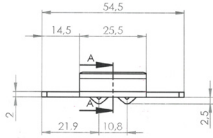

TIENDA

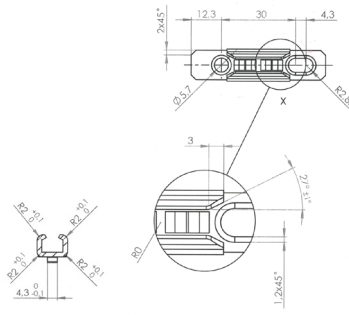
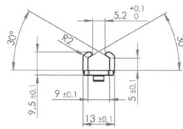
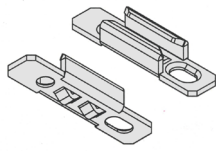

REF.
1.000 P2426

Cerradero multipunto corredera



TIENDA



REF.
1.000 P2407

Seguro antilevantamiento



TIENDA



REF.
500 P2420

Cerradero multipunto corredera



TIENDA



REF.
500 P2422

Embellecedor para pincho corredera



TIENDA



REF.
500 P2421

Calzo adaptador de cerradero



TIENDA



REF.
500 P3108

Calzos para multipunto

P3112

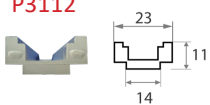

P3115

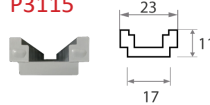

P3113

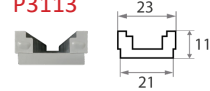

P3109



TIENDA



DESCRIPCIÓN		REF.
CALZO MULTIPUNTO DESNIVEL DE 21mm	100	P3113
CALZO MULTIPUNTO DESNIVEL DE 14mm	100	P3112
CALZO MULTIPUNTO DESNIVEL DE 17mm	100	P3115
CALZO MULTIPUNTO LISO DE 24mm	100	P3109

NUEVO CERRADERO VÁLIDO PARA PVC Y ALUMINIO

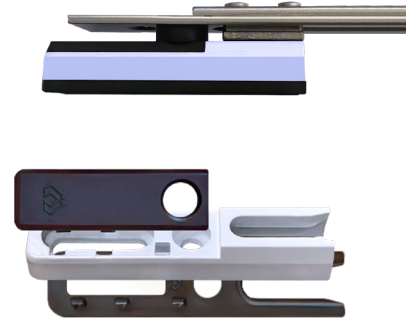

Cerradero válido para Aluminio y PVC blanco.

 REF.
100 P2445-9016

TIENDA



Häusen



Cerradero válido para Aluminio y PVC negro.

 REF.
100 P2445-9005

TIENDA



Häusen



Base perimetral para cerradero (solo para aluminio).

 REF.
100 P2442

TIENDA



Häusen



Tapa anti-levantamiento para cerradero.

 REF.
100 P2443

TIENDA



Häusen

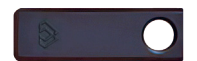

Tapa ciega para cerradero.

 REF.
100 P2444

TIENDA



Häusen



Rueda Radow PVC Tandem Pequeña Kommerling



Rueda Radow PVC Tandem Pequeña Kommerling

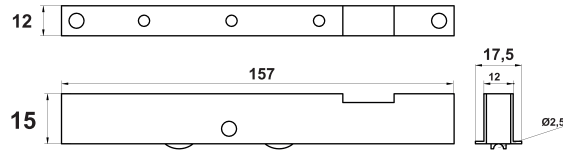

Rueda Radow PVC Tandem Kommerling

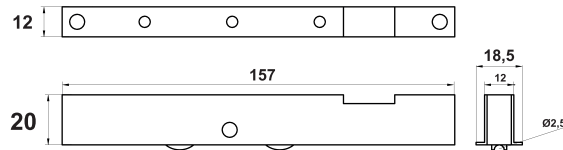

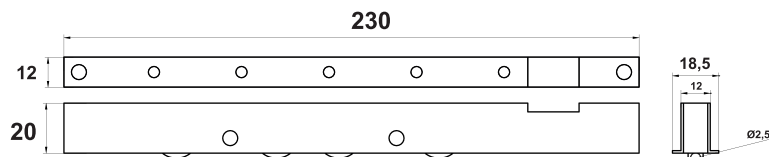

Rueda Radow PVC Doble Tandem Kommerling



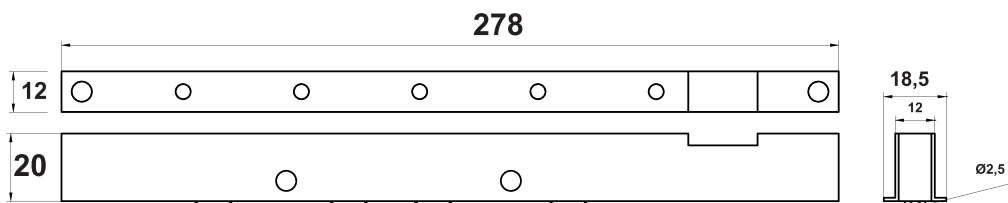

Rueda Radow PVC Triple Tandem Kommerling





Rueda Radow PVC Tandem Pequeña Fija **Kommerling**

		REF.
140	INOX	P4810



Rueda Radow PVC Tandem Pequeña **Kommerling**

		REF.
140	INOX	P4812



Rueda Radow PVC Tandem **Kommerling**

		REF.
140	INOX	P4808



Rueda Radow PVC Doble Tandem **Kommerling**

		REF.
140	INOX	P3154

Rueda Radow PVC Triple Tandem **Kommerling**

		REF.
140	INOX	P3158

Mechon para base ruedas PVC

			REF.	€
200	INOX	28 mm.	P3150	0,55
200	INOX	24 mm.	P3151	0,55



TIENDA



TIENDA



Calzo Cerradero Desplazado

		REF.
250	9016	P4822-9016
250	9005	P4822-9005



TIENDA



Cortavientos PVC

		REF.
100	9016	P4820-9016
100	9005	P4820-9016



DECEUNICK

TIENDA



Ruedas correderas PVC tándem y doble tándem regulable DECEUNICK





MODELO	SERIE					REF.
Tándem	DECEUNICK	156 x 12 x 20	2	200	5,20	P4818
Doble tándem	DECEUNICK	230 x 12 x 20	2	140	4,90	P3164
Triple tándem	DECEUNICK	280 x 12 x 20	2	100	4,20	P4817

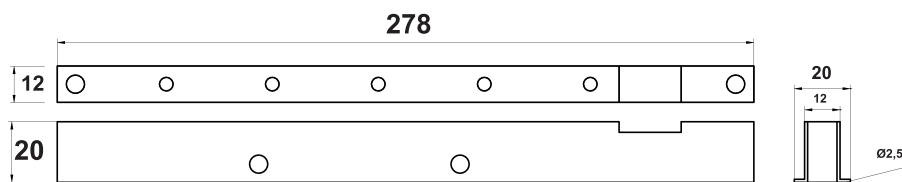
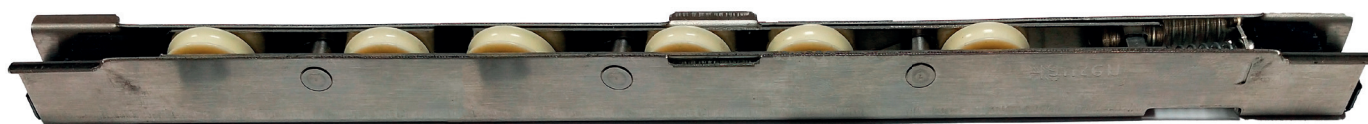
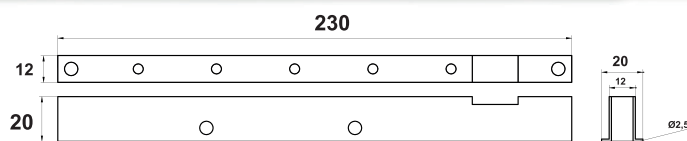
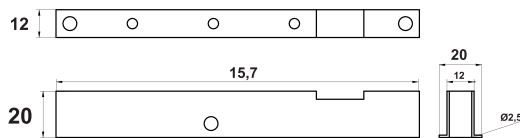

Ruedas correderas PVC tándem y doble tándem regulable



Ruedas correderas PVC tándem y doble tándem regulable

MODELO	SERIE					REF.
Tándem	CORTIZO	156 x 12 x 20	2	200	5,20	P4830
Doble tándem	CORTIZO	230 x 12 x 20	2	140	4,90	P4831
Triple tándem	CORTIZO	280 x 12 x 20	2	100	4,20	P4832
Tándem	VEKA	156 x 12 x 20	2	200	5,20	P4840
Doble tándem	VEKA	230 x 12 x 20	2	140	4,90	P4841
Triple tándem	VEKA	280 x 12 x 20	2	100	4,20	P4842
Tándem	GEALAN	156 x 12 x 20	2	200	5,20	P4850
Doble tándem	GEALAN	230 x 12 x 20	2	140	4,90	P4851
Triple tándem	GEALAN	280 x 12 x 20	2	100	4,20	P4852
Tándem	SALAMANDER	156 x 12 x 20	2	200	5,20	P4860
Doble tándem	SALAMANDER	230 x 12 x 20	2	140	4,90	P4861
Triple tándem	SALAMANDER	280 x 12 x 20	2	100	4,20	P4862
Tándem	ALUPLAST	156 x 12 x 20	2	200	5,20	P4835
Doble tándem	ALUPLAST	230 x 12 x 20	2	140	4,90	P4836
Triple tándem	ALUPLAST	280 x 12 x 20	2	100	4,20	P4837
Tándem	REHAU	156 x 12 x 20	2	200	5,20	P4845
Doble tándem	REHAU	230 x 12 x 20	2	140	4,90	P4846
Triple tándem	REHAU	280 x 12 x 20	2	100	4,20	P4847

Cierre multipunto abatible 7,5mm

	A	B	C	D	E						REF.
210-280	210	-	-	-	50,5	2	1	50	8,82	215x200x115	P2730
280-400	280	-	-	74	74	2	2	50	10,52	300x200x115	P2741
400-600	400	-	-	135	135	3	2	50	12,81	410x200x115	P2737
600-800	600	-	-	175	175	8	2	50	15,76	615x200x115	P2735
800-1.000	800	-	-	275	275	8	2	50	20,30	815x200x115	P2736
1.000-1.200	1.000	94	-	375	375	10	3	50	24,60	1.015x200x115	P2742
1.200-1.400	1.200	94	-	475	475	10	3	50	29,29	1.210x200x115	P2738
1.400-1.600	1.400	266	266	575	575	10	3	25	17,64	1.415x200x115	P2739
1.600-1.800	1.600	300	300	675	675	10	3	25	20,12	1.610x200x115	P2740
1.800-2.000	1.800	300	300	775	775	12	4	25	22,42	1.810x200x115	P2743
2.000-2.200	2.000	300	300	875	875	12	4	25	24,63	2.010x200x115	P2744

TIENDA

Häusen®



Pin estándar

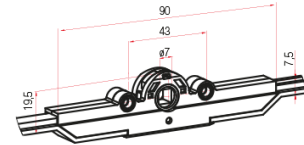
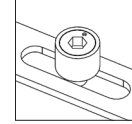

Cierre multipunto corredera 7,5mm

	A	B	C	D	E	F						REF.
400-600	400	-	-	135	135	106,5	3	2	50	10,11	430x200x115	P2729
600-800	600	-	-	175	175	106,5	8	2	50	15,76	630x200x115	P2731
800-1.000	800	-	-	275	275	106,5	8	2	50	20,30	830x200x115	P2732
1.000-1.200	1.000	94	-	375	375	131,5	10	3	50	24,60	1.030x200x115	P2733
1.200-1.400	1.200	94	-	475	475	166	10	3	50	29,29	1.230x200x115	P2734
1.400-1.600	1.400	266	266	575	575	166	10	3	25	17,00	1.430x200x115	P2792
1.600-1.800	1.600	300	300	675	675	200	10	3	25	19,00	1.630x200x115	P2793
1.800-2.000	1.800	300	300	775	775	200	12	4	25	21,60	1.830x200x115	P2794
2.000-2.200	2.000	300	300	875	875	200	12	4	25	23,85	2.030x200x115	P2795

Pin seguridad

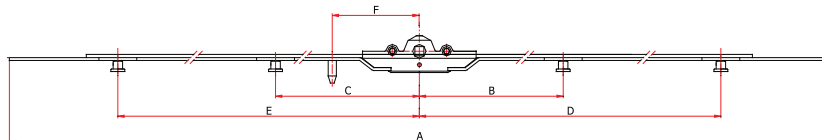
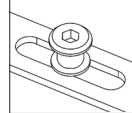

TIENDA



Cierre multipunto universal 7,5mm

	A	B	C	D	E	F						REF.
210-280	267	-	80,2	-	7,5	26,8	2	1	50	1,80	267x200x115	P2401
600-800	596	212	212	-	7,5	32	6	2	50	3,00	600x200x115	P2402
1.000-1.200	996	412	412	-	7,5	32	6	2	50	4,80	1.000x200x115	P2403
1.400-1.600	-	-	-	-	7,5	32	6	3	20	5,50	1.430x200x115	P2418
1.600-1.800	-	-	-	-	7,5	32	10	3	20	6,70	1.630x200x115	P2448
1.800-2.000	1.796	812	812	120	7,5	32	10	3	20	8,65	1.800x200x115	P2408

Pin Zamac

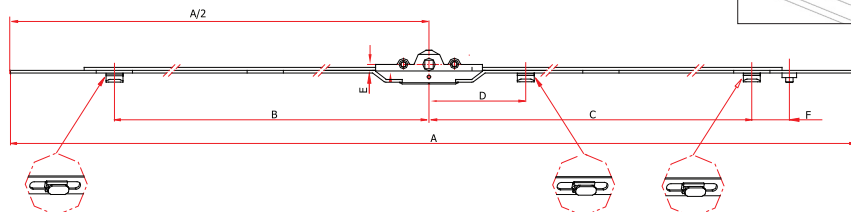
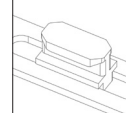

TIENDA

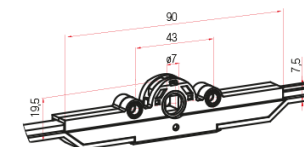

Häusen®

TIENDA



Pin estándar

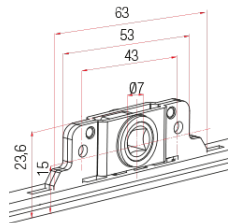
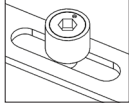

Cierre multipunto abatible (caja pequeña) 15mm

	A	A/2	B	C	D	E						REF.
400-600	400	200	-	-	134	134	4	2	50	10,11	430x200x115	P2723
600-800	600	300	-	-	175	175	6	2	50	15,76	630x200x115	P2703
800-1.000	800	400	-	-	275	275	8	2	50	20,30	830x200x115	P2710
1.000-1.200	1.000	500	114	-	375	375	10	3	50	24,60	1.030x200x115	P2704
1.200-1.400	1.200	600	216	-	475	475	10	3	50	29,29	1.230x200x115	P2724
1.400-1.600	1.400	700	266	266	575	575	10	3	25	17,00	1.430x200x115	P2705
1.600-1.800	1.600	800	300	300	675	675	10	3	25	19,00	1.630x200x115	P2725
1.800-2.000	1.800	900	300	300	775	775	12	4	25	21,60	1.830x200x115	P2706
2.000-2.200	2.000	1.000	300	300	875	875	12	4	25	23,85	2.030x200x115	P2726

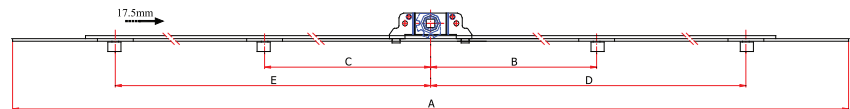

Cierre multipunto corredera (caja pequeña) 15mm

	A	B	C	D	E	F						REF.
600-800	600	-	-	175	175	106,5	8	2	50	12,55	630x200x115	P2711
800-1.000	800	-	-	275	275	106,5	8	2	50	18,00	830x200x115	P2712
1.000-1.200	1.000	94	-	375	375	131,5	10	3	50	22,00	1.030x200x115	P2713
1.200-1.400	1.200	94	-	475	475	166	10	3	50	25,6	1.230x200x115	P2714
1.400-1.600	1.400	266	266	575	575	166	10	3	25	15,00	1.430x200x115	P2716
1.600-1.800	1.600	300	300	675	675	200	10	3	25	19,15	1.630x200x115	P2717
1.800-2.000	1.800	300	300	775	775	200	12	4	25	21,70	1.830x200x115	P2718
2.000-2.200	2.000	300	300	875	875	200	12	4	25	22,00	2.030x200x115	P2719

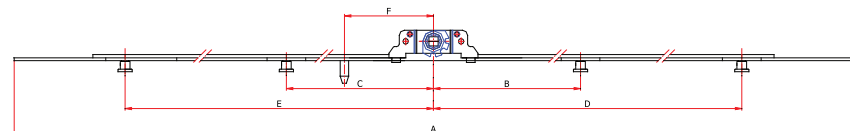

TIENDA



Pin seguridad



Häusen®

TIENDA



Pin estándar

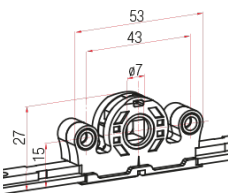
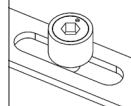

Cierre multipunto abatible 15mm

	A	B	C	D	E						REF.
210-280	210	-	-	-	50,5	2	1	10	1,28	240x205x125	P2659
280-400	280	-	-	74	74	2	2	10	1,62	310x205x125	P2660
400-600	400	-	-	135	135	4	2	10	2,07	430x205x125	P2661
600-800	600	-	-	175	175	8	3	10	2,66	630x205x125	P2662
800-1.000	800	-	-	275	275	8	3	10	3,57	830x205x125	P2663
1.000-1.200	1.000	94	-	375	375	10	3	10	4,50	1.030x205x125	P2697
1.200-1.400	1.200	94	-	475	475	10	3	10	5,37	1.230x205x125	P2664
1.400-1.600	1.400	266	266	575	575	10	3	10	6,57	1.430x175x70	P2698
1.600-1.800	1.600	300	300	675	675	10	3	10	7,60	1.630x175x70	P2699
2.000-2.200	2.000	300	300	875	875	12	4	10	9,36	2.030x200x115	P2700

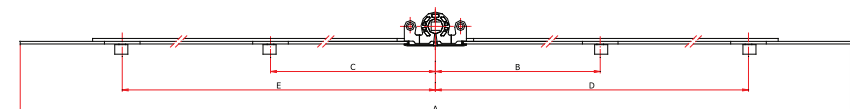

Cierre multipunto corredera 15mm

	A	B	C	D	E	F						REF.
600-800	600	-	-	175	175	106,5	8	2	50	2,66	630x200x115	P2760
800-1.000	800	-	-	275	275	106,5	8	2	50	3,57	830x200x115	P2761
1.000-1.200	1.000	94	-	375	375	131,5	10	3	50	4,50	1.030x200x115	P2762
1.200-1.400	1.200	94	-	475	475	166	10	3	50	5,37	1.230x200x115	P2715
1.400-1.600	1.400	266	266	575	575	166	10	3	25	6,57	1.430x200x115	P2763
1.600-1.800	1.600	300	300	675	675	200	10	3	25	7,60	1.630x200x115	P2764
1.800-2.000	1.800	300	300	775	775	200	12	4	25	8,40	1.830x200x115	P2765
2.000-2.200	2.000	300	300	875	875	200	12	4	25	9,36	2.030x200x115	P2766

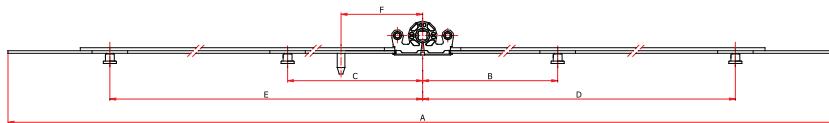

TIENDA

Häusen



Pin seguridad

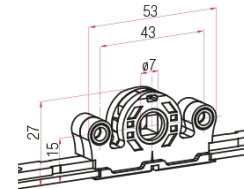
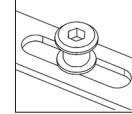

Cierre multipunto universal para 15mm

	A	A/2	B	C	D	E						REF.
210-280	210	105	-	52,7	-	15	2	1	50	1,28	240x205x125	P2404
600-800	600	300	214	214	-	15	6	2	50	2,66	630x205x125	P2405
1.000-1.200	1.000	500	414	414	-	15	6	2	50	4,50	1.030x205x125	P2406
1.400-1.600	-	-	-	-	-	15	6	3	20	5,50	1.430x200x115	P2419
1.600-1.800	-	-	-	-	-	15	10	3	20	6,70	1.630x200x115	P2449
1.800-2.000	1.800	900	814	814	122	15	12	3	20	8,40	1.830x175x70	P2409

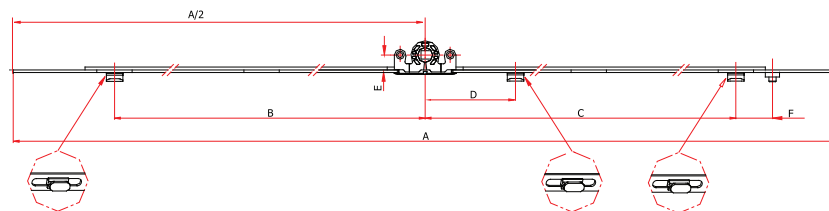

Pin Zamac

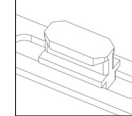

TIENDA



Cierre multipunto correderas con llave 15mm

	A	A/2	B	C	D	E						REF.
1.600-1.800	1.600	800	-	-	675	675	10	3	15	23,00	1.610x165x85	P2720
1.800-2.000	1.800	900	300	320	775	775	12	4	15	26,00	1.810x165x85	P2722
1.800-2.000	1.800	900	300	320	775	775	12	4	15	26,00	1.810x165x85	P2727
2.000-2.200	2.000	1.000	300	320	875	875	12	4	15	18,00	2.010x165x85	P2721

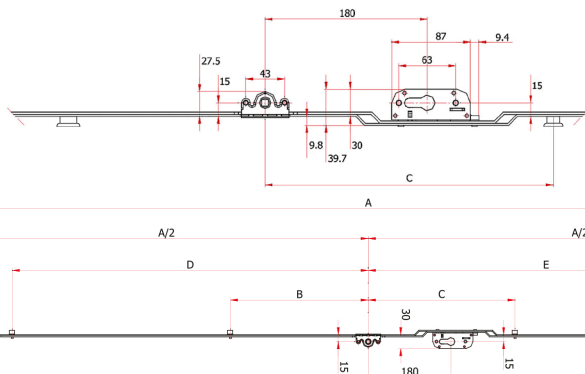

Pin Zamac

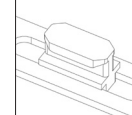

TIENDA



Cierre multipunto 22mm bulón estándar y seguridad



TIENDA

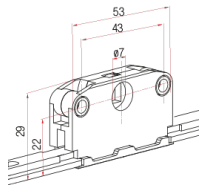

	A	B	C	D	E						REF. B.STÁNDAR	REF. B.SEGURIDAD
210-280	210	-	-	50,5	2	1	10	6,00	210x205x120	P2749	P2707	
280-400	280	-	-	74	74	2	2	10	7,37	320x205x120	P2750	P2708
400-600	400	-	-	135	135	4	2	10	9,21	430x205x120	P2751	P2709
600-800	600	-	-	175	175	8	2	10	11,58	630x205x120	P2752	P2767
800-1.000	800	-	-	275	275	8	2	10	15,22	830x205x120	P2753	P2768
1.000-1.200	1.000	94	-	375	375	10	3	10	18,67	1.030x205x120	P2754	P2769
1.200-1.400	1.200	94	-	475	475	10	3	10	22,43	1.230x205x120	P2755	P2770
1.400-1.600	1.400	266	266	575	575	10	3	10	13,66	1.430x205x120	P2756	P2771
1.600-1.800	1.600	300	300	675	675	10	3	10	15,65	1.630x205x120	P2757	P2772
1.800-2.000	1.800	300	300	775	775	12	4	10	17,50	1.830x205x120	P2758	P2773
2.000-2.200	2.000	300	300	875	875	12	4	10	19,27	2.030x205x120	P2759	P2774

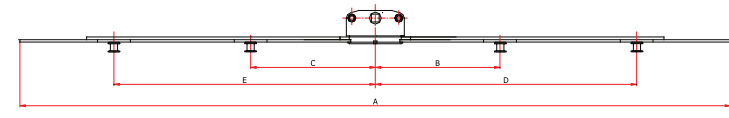
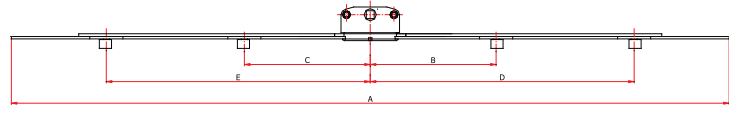

Cierre multipunto 25mm bulón estándar y seguridad



TIENDA

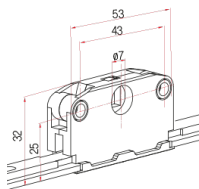

	A	B	C	D	E						REF. B.STÁNDAR	REF. B.SEGURIDAD
210-280	210	-	-	50,5	2	1	40	6,10	235x200x120	P2430	-	
280-400	280	-	-	74	74	2	2	40	7,53	315x200x120	P2431	-
400-600	400	-	-	135	135	4	2	40	9,37	425x200x120	P2432	P2851
600-800	600	-	-	175	175	8	2	40	11,74	625x200x120	P2433	P2852
800-1.000	800	-	-	275	275	8	2	40	15,38	825x200x120	P2434	P2853
1.000-1.200	1.000	94	-	375	375	10	3	40	18,38	1.025x200x120	P2435	P2854
1.200-1.400	1.200	94	-	475	475	10	3	40	22,59	1.255x200x120	P2436	P2855
1.400-1.600	1.400	266	266	575	575	10	3	20	13,74	1.450x160x120	P2437	P2856
1.600-1.800	1.600	300	300	675	675	10	3	20	15,73	1.625x160x120	P2438	P2857
1.800-2.000	1.800	300	300	775	775	12	4	20	17,58	1.825x160x120	P2439	P2858
2.000-2.200	2.000	300	300	875	875	12	4	20	19,35	2.025x160x120	P2440	P2859

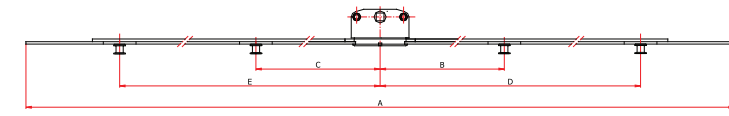
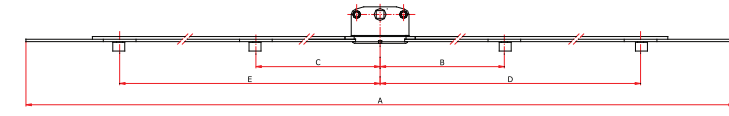

Cierre multipunto abatible 40mm



TIENDA

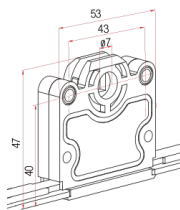

	A	A/2	B	C	D	E						REF.
1.600-1.800	1.600	-	300	300	675	675	10	3	25	12,52	1.610x210x120	P2415
1.800-2.000	1.800	-	300	300	775	775	12	4	25	13,92	1.810x210x120	P2416
2.000-2.200	2.000	-	300	300	875	875	12	4	25	15,25	2.030x210x120	P2417

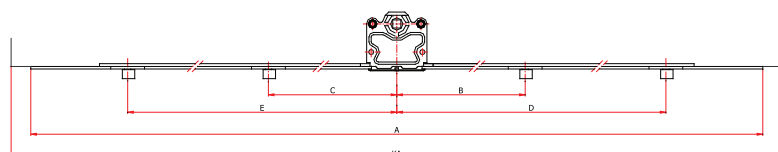

Kit guiado de corredera

	DESCRIPCIÓN	REF.
75	Kit guiado Alup. 24 cortav. caucho	94505
75	Kit guiado Alup. 24 cortav. felpudo	94654
75	Kit guiado s/Élite pta. cortav. felpudo	94071
75	Kit guiado s/P92 cortav. felpudo	92918
50	Kit guiado s/2300 Jativa cortav. caucho	94616
50	Kit guiado s/640 - Alup.21 Cortav. caucho	94638
50	Kit guiado s/Marina 70 cortav. felpudo	92974

TIENDA

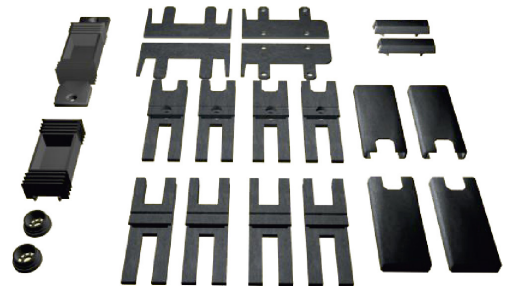

Kit superpuesto de corredera

	DESCRIPCIÓN	REF.
100	Kit superpuesto s/2300 caucho	94607
75	Kit superpuesto s/640 Alup. 21 caucho	94015
75	Kit superpuesto Alup. 24 caucho	94789
75	Kit superpuesto s/lg caucho	96364
75	Kit superpuesto s/Élite pta. caucho	96228
75	Kit superpuesto s/A300 Euro caucho	94621
75	Kit superpuesto s/Marina 70 caucho	96537
75	Kit superpuesto s/ Marina 75 caucho	92844
75	Kit superpuesto s/ lg Giralda felpudo	94017
75	Kit superpuesto P-92 felpudo	94790

TIENDA

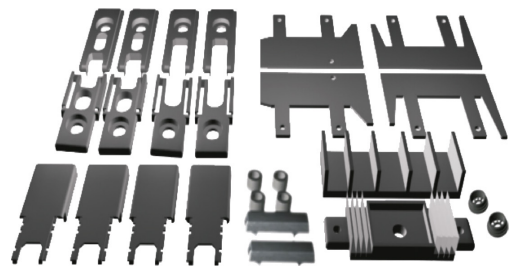

Cierre central II/iguales

	RAL	REF.
20	9016	94130
20	9005	94131

TIENDA



Pulsador con cerradura II/iguales

	REF.
10	99570

TIENDA



Uñero con cerradura II/iguales

	RAL	REF.
20	9016	98878
20	9005	99032

TIENDA





Asa con cerradura II/iguales

	RAL	REF.
20	9016	99651
20	9005	99652

TIENDA



Prolongador cerradura

		REF.
50	26mm	92703
50	36mm	98930

TIENDA



NUEVO

Cierre minimalista corredera 7mm.

					REF.
20	200 x 185 x 240	16,00	NO	9016	H6005-9016
20	200 x 185 x 240	16,00	NO	9005	H6005-9005
20	200 x 185 x 240	16,00	NO	ANOD	H6005-ANOD
20	200 x 185 x 240	16,00	NO	RAL	H6005-RAL

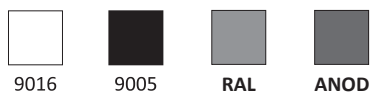



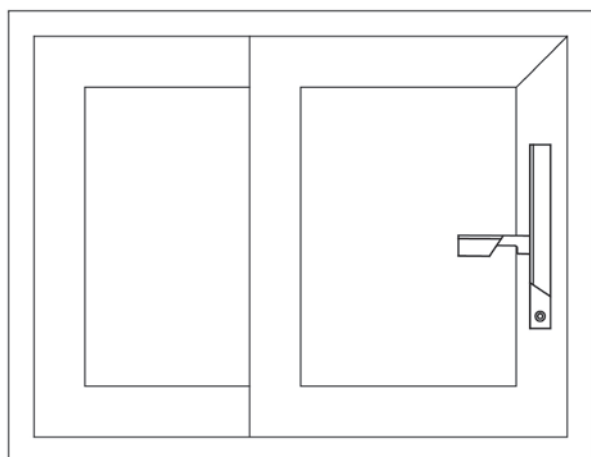
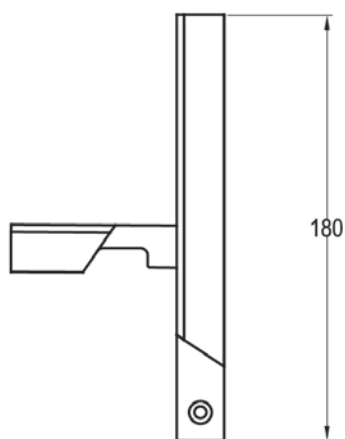
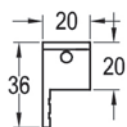

TIENDA



NUEVO

Cierre embutido multipunto S/Europa 7MM.

					REF.
20	200 x 185 x 240	15,00	NO	9016	H6003-9016
20	200 x 185 x 240	15,00	NO	9005	H6003-9005
20	200 x 185 x 240	15,00	NO	ANOD	H6003-ANOD
20	200 x 185 x 240	15,00	NO	RAL	H6003-RAL

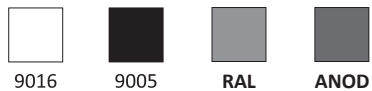

TIENDA

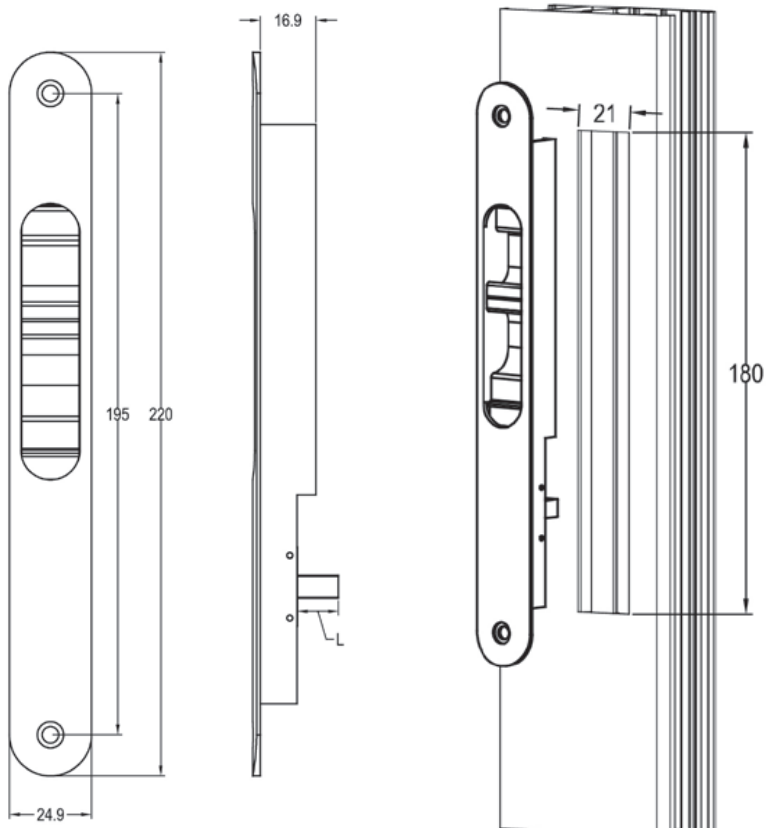

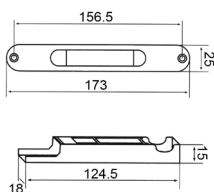

Cierre embutido sin tornillos

TIENDA



	RAL	REF.
100	9016	H6080-9016
100	9005	H6080-9005
100	B/N	H6080-BN



Cierre embutido con tornillos

TIENDA



	RAL	REF.
100	9016	92737
100	9005	92739



Cierre embutido estrecho de fundición

TIENDA



	RAL	REF.
100	9016	J5010-9016
100	9005	J5010-9005



Cierre embutido ancho de fundición

TIENDA



	RAL	REF.
100	9016	J5011-9016
100	9005	J5011-9005

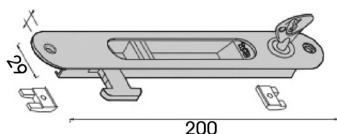

Cierre embutido simple con llave

TIENDA



	RAL	REF.
10	9016	99718
10	9005	99714
10	9006	94578

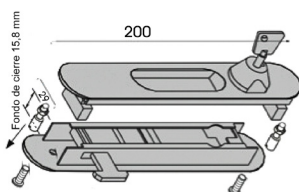

Cierre embutido doble con llave

TIENDA



	RAL	REF.
10	9016	98497
10	9005	98498

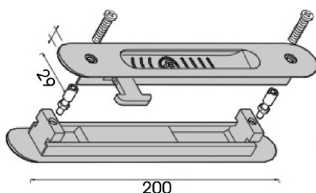

Cierre embutido doble sin llave

TIENDA



	RAL	REF.
10	9016	85248
10	9005	85249
10	9006	85250

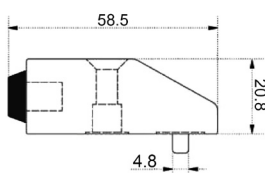

Topeco - Tope de corredera

TIENDA



	RAL	REF.
30	9016	92273
30	9005	94623

Series: Marina / Bolas G47013

Rodamiento tándem regulable

	REF.
100	94068

TIENDA

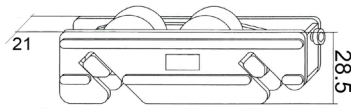

Series: Aluprom 24 / P17023BR

Rodamiento tándem regulable

	REF.
100	94084

TIENDA

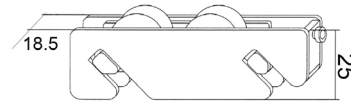

Series: Aluprom 24 / Bolas P17023

Rodamiento tándem regulable

	REF.
100	94099

TIENDA

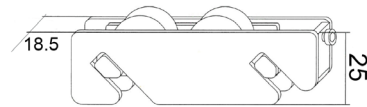

Series: Aluprom 21 / Bolas P17008

Rodamiento tándem regulable

	REF.
100	94070

TIENDA



Series: A-18 / Aguja C6

Rodamiento tándem regulable

	REF.
100	92297

TIENDA

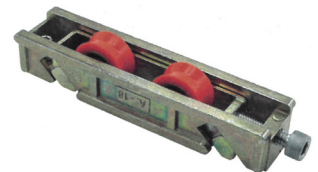

Series: A-18 / Bolas

Rodamiento tándem regulable

	REF.
100	94957

TIENDA

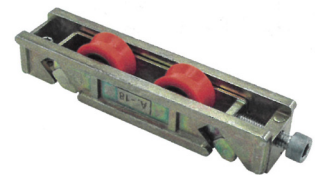

Series: 300 / RT18012

Rodamiento tándem regulable

	REF.
100	92856

TIENDA



Series: 800 / 19018DH

Rodamiento tándem regulable

	REF.
100	94089

TIENDA

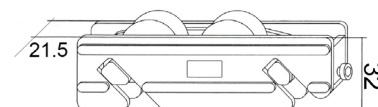

Series: Marina / G17013A.C8

Rodamiento tándem regulable



TIENDA

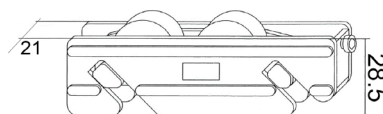

	REF.
100	94029

Series: Sopena 2300 / Alugón 3500

Rodamiento tándem regulable

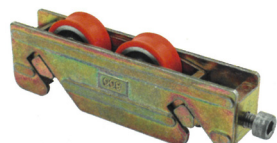

TIENDA



	REF.
100	94617

Series: P-70 / P17049BR

Rodamiento tándem regulable



TIENDA

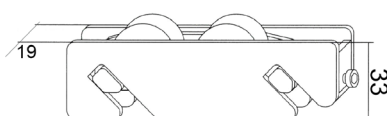

	REF.
100	94047

Series: 2300 / A400

Rodamiento fijo nylon



TIENDA

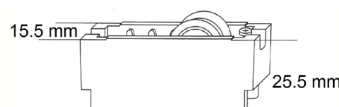

	REF.
200	92923

Series: 300

Rodamiento fijo nylon



TIENDA

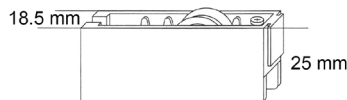

	REF.
200	96182

Series: 640 / A421

Rodamiento fijo nylon



TIENDA

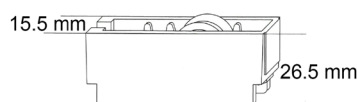

	REF.
200	94096

Series: 800

Rodamiento fijo nylon



TIENDA

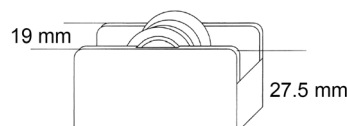

	REF.
200	94714

Series: Elite A-24

Rodamiento fijo nylon



TIENDA

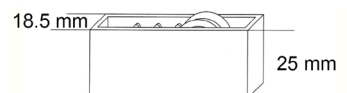

	REF.
200	94504

Series: P60 / P65

Rodamiento fijo nylon

	REF.
200	94109

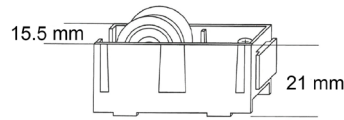

Series: Diana

Rodamiento fijo nylon

	REF.
200	85240

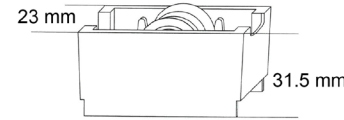

Series: Marina / G96 / 7180

Rodamiento fijo nylon

	REF.
200	94030

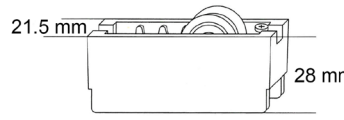

Series: Aluprom 21 / 640

Rodamiento regulable

	REF.
150	94088

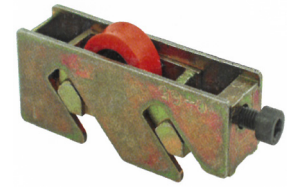
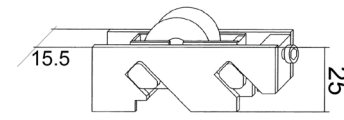

Series: P92

Rodamiento regulable

	REF.
150	94044

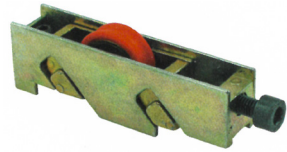
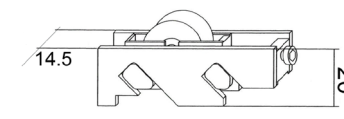

Series: 800 / 15018DH

Rodamiento regulable

	REF.
150	94028

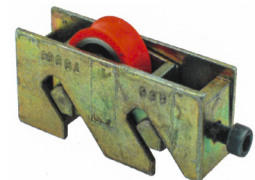
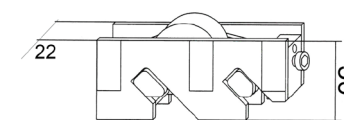

Series: A300 / 1201BR

Rodamiento regulable

	REF.
150	96275

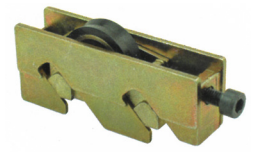
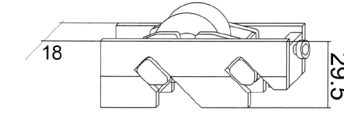

Series: 2300 / 15007BR

Rodamiento regulable

	REF.
150	94107

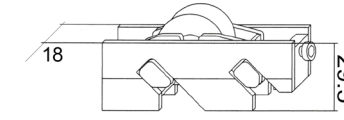

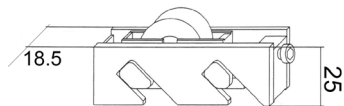
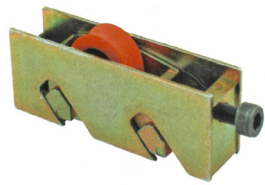

TIENDA



Series: A24

Rodamiento regulable

REF.
150 96181

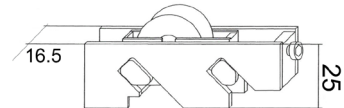
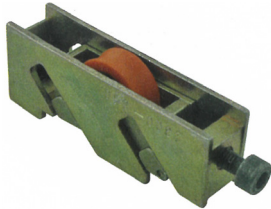

TIENDA



Series: Diana / 15037DH

Rodamiento regulable

REF.
150 94064

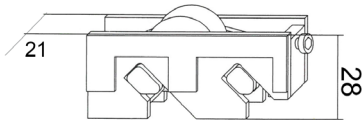
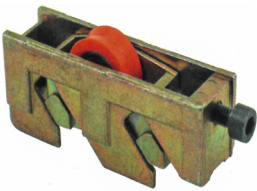

TIENDA



Series: 7180

Rodamiento regulable

REF.
150 94038

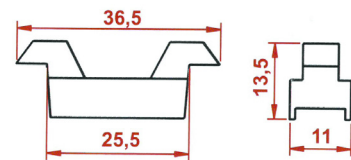
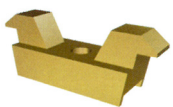

TIENDA



Series: Marina / G96

Contrachierre

REF.
500 92748

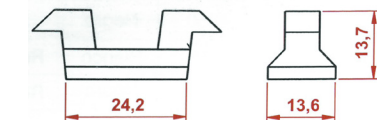
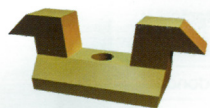

TIENDA



Series: Aluprom 24 / P92

Contrachierre

REF.
500 94020

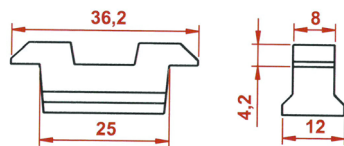
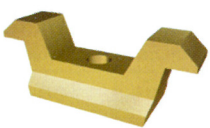

TIENDA



Series: 300 / Alugón

Contrachierre

REF.
500 94622

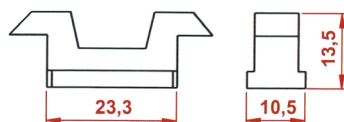
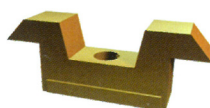

TIENDA



Series: Giralda

Contrachierre

REF.
500 94021

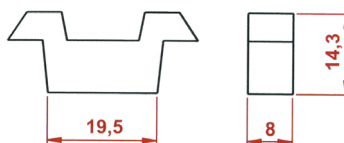
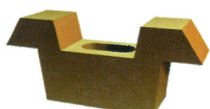

TIENDA



Series: Diana / 2300

Contrachierre

REF.
500 94022

Series: 800

Contracierre

	REF.
500	92752

TIENDA

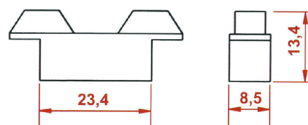

Series: 7180

Contracierre

	REF.
500	92775

TIENDA

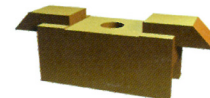

Series: 2300

Contracierre

	REF.
500	92773

TIENDA

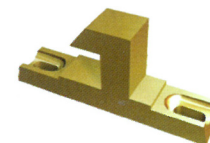
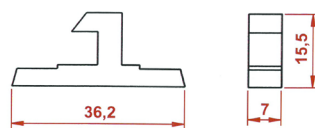

Series: 640

Contracierre

	REF.
500	92288

TIENDA

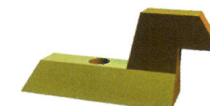
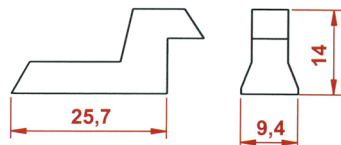

Contracierre perimetral

	REF.
500	85244

TIENDA

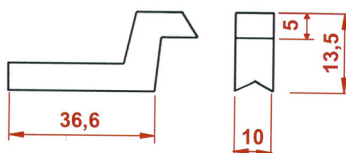

Uña de cierre perimetral

	REF.
500	94075

TIENDA

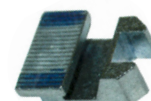
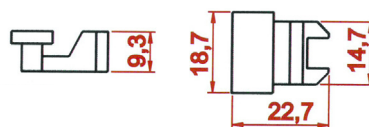

Uña cierre zk recta

	REF.
500	92743

TIENDA

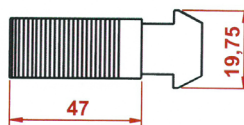

Uña cierre acero despl. 1mm

	REF.
500	H6081

TIENDA

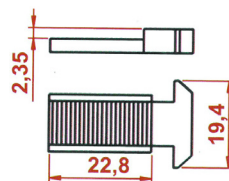

Uña cierre zk despl. 2mm

	REF.
500	92769

TIENDA

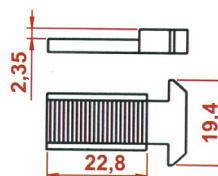

APERTURA PROYECTANTE

Häusen®

Bisagra proyectante inox ss304

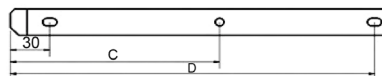
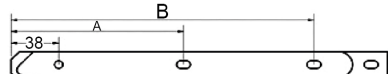
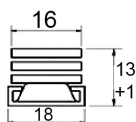
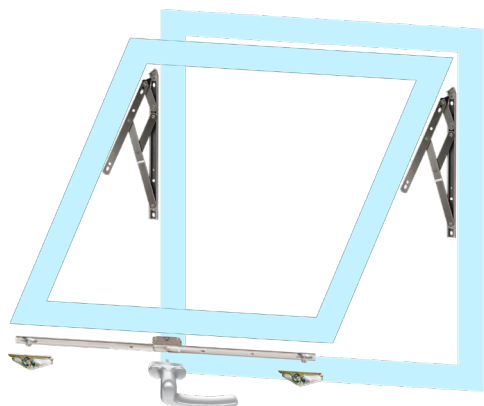

TIENDA



		POSICIÓN	LA	B	C	D	ALTO	ANCHO		APERTURA	REF.
50	8"	Der./Izq.	53	146	140	206	350	1.200	12,00 Kg	70°	J1610
50	12"	Der./Izq.	81	201	220	302	550	1.200	20,00 Kg	87°	J1611
50	16"	Der./Izq.	139	265	315	405	750	1.200	24,00 Kg	87°	J1612
50	24"	Der./Izq.	258	360	225	608	1.100	1.200	35,00 Kg	40°	J1613

Häusen®

Compás carraca PVC

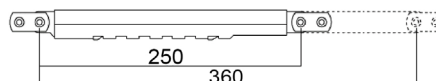

	REF.
10	96171

TIENDA



Häusen®

Compás carraca C.E.

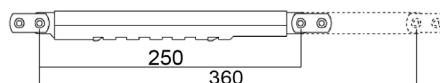
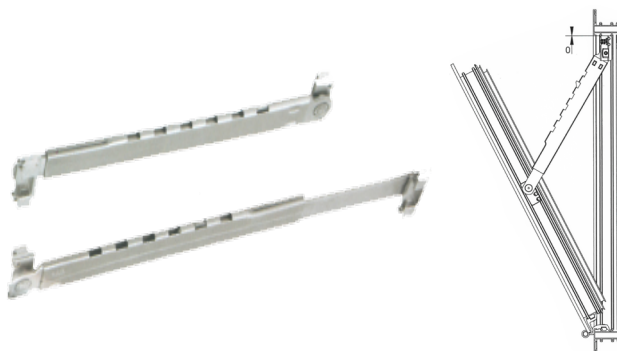

	REF.
10	J1024

TIENDA



Compás de seguridad

RAL					REF.
INOX	6	250	12,20	245x220x200	P2351-INOX

TIENDA

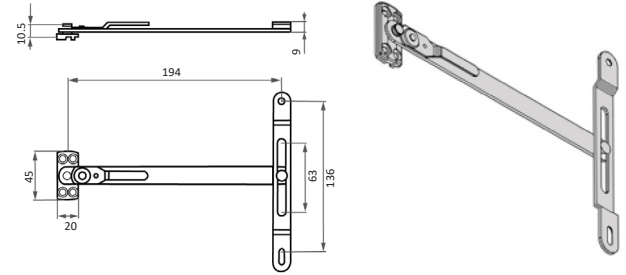

Häusen

Compás 130mm / 200mm

RAL					REF.	
9016	130mm	4	200	15,47	315x235x245	P2353-9016
8019	130mm	4	200	15,47	315x235x245	P2353-8019
9016	200mm	4	200	9,95	315x235x245	P2354-9016
8019	200mm	4	200	9,95	315x235x245	P2354-8019
8022	200mm	4	200	9,95	315x235x245	P2354-8019

TIENDA

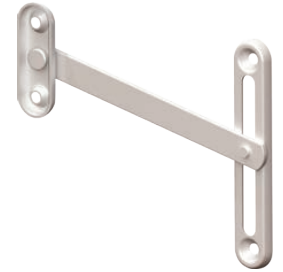

Häusen

Compás 170mm

RAL					REF.
9016	3	250	16,70	250x215x185	P2352-9016
8019	3	250	16,70	250x215x185	P2352-8019
8022	3	250	16,70	250x215x185	P2352-8022
INOX	3	250	16,70	250x215x185	P2352-INOX

TIENDA

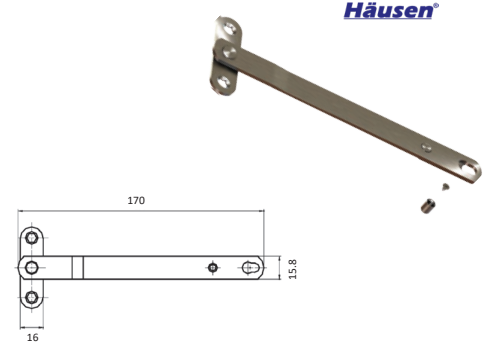

Häusen

Compás retenedor corto inox 250mm
Acero inoxidable SS304, para hojas de tamaño desde 445mm

				REF:
100	250mm	360 x 280 x 180	13,00	Z0019

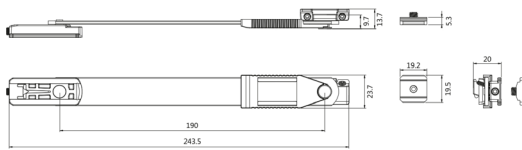

TIENDA



1.000 horas de lluvia salina certificadas

ZENIT

Compás retenedor largo inox 300mm
Acero inoxidable SS304, para hojas de tamaño desde 445mm

				REF:
100	300mm	360 x 280 x 180	13,00	Z0020

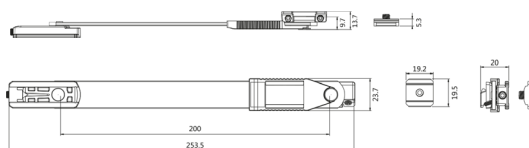

TIENDA



1.000 horas de lluvia salina certificadas

ZENIT

DETROIT

CERRADURA ANTIPÁNICO

CE

EN 1125:2008
0370
365B1322AA

CE

EN 1935:2008
0370
475112112

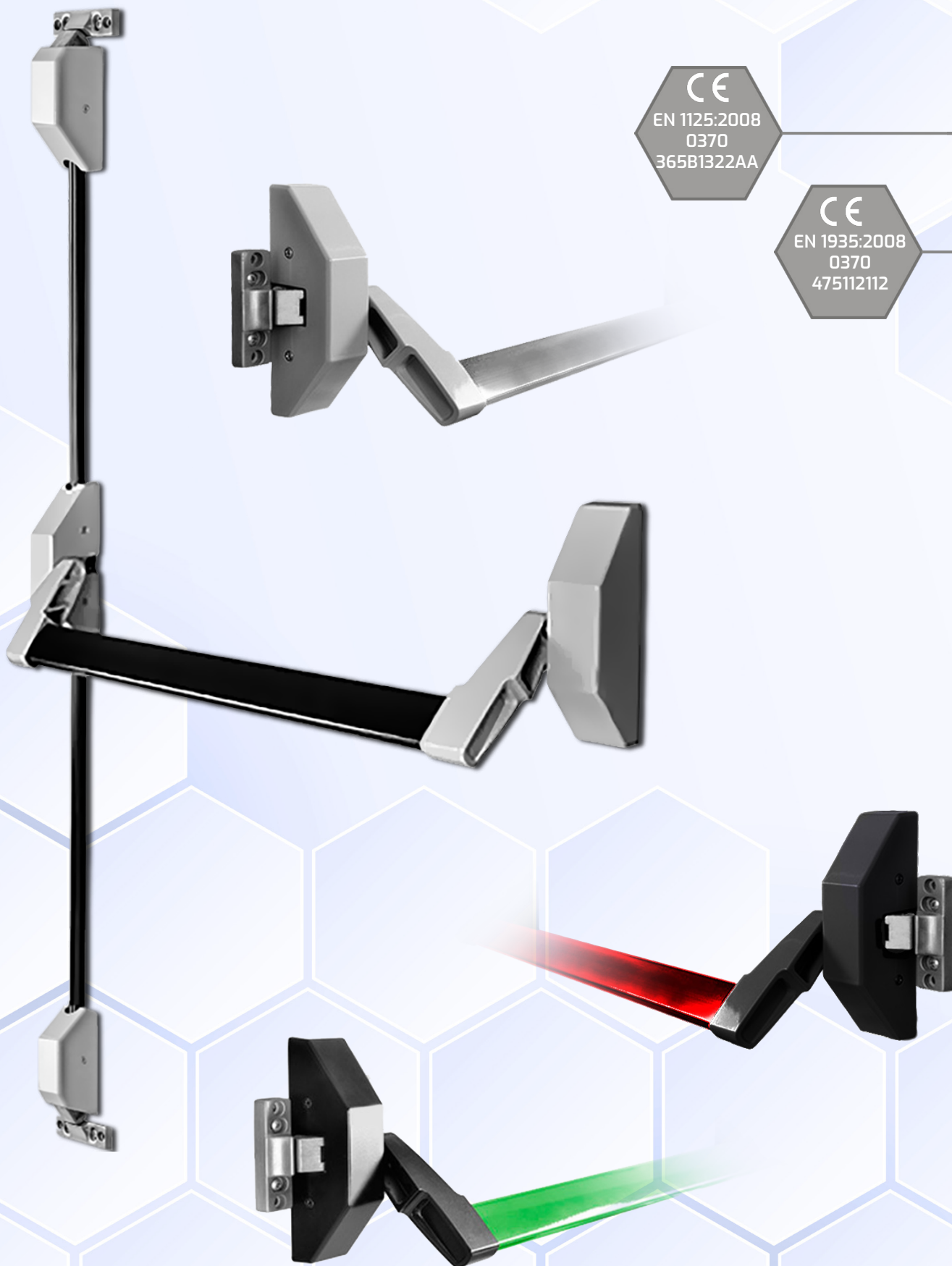



Conjunto antipánico Detroit 1 hoja p/llave

REF.
1 H8500-9005
1 H8500-ROJO
1 H8500-VERDE
1 H8500-INOX

H8500-9005 (PLATA/NEGRO)

H8500-INOX (INOX/INOX)

H8500-ROJO (NEGRO/ROJO)

H8500-VERDE (NEGRO/VERDE)

TIENDA

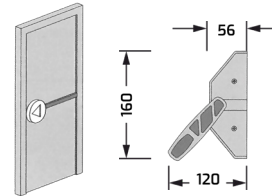
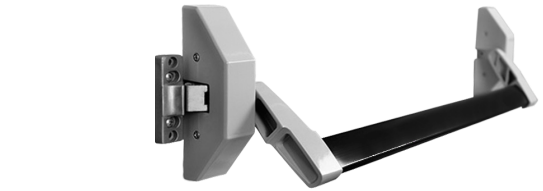

Conjunto antipánico Detroit 1 hoja s/llave

REF.
1 H8501-9005
1 H8501-ROJO
1 H8501-VERDE
1 H8501-INOX

H8500-9005 (PLATA/NEGRO)

H8500-INOX (INOX/INOX)

H8500-ROJO (NEGRO/ROJO)

H8500-VERDE (NEGRO/VERDE)

TIENDA

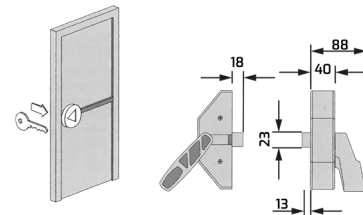

Conjunto antipánico Detroit 2ª hoja

REF.
1 H8504-9005
1 H8504-ROJO
1 H8504-VERDE
1 H8504-INOX

H8500-9005 (PLATA/NEGRO)

H8500-INOX (INOX/INOX)

H8500-ROJO (NEGRO/ROJO)

H8500-VERDE (NEGRO/VERDE)

TIENDA

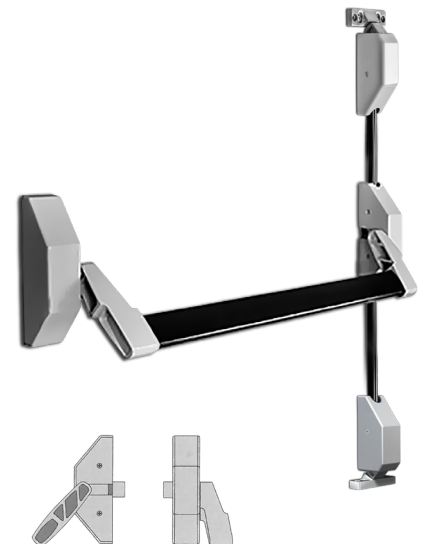
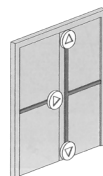



Manilla antipánico Detroit sin llave

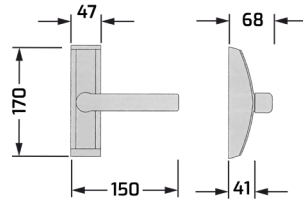

RAL		REF.
9005	1	H8502-9005
9006	1	H8502-9006

TIENDA



Manilla antipánico Detroit con llave

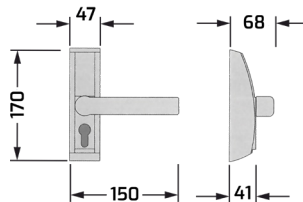

RAL		REF.
9005	1	H8503-9005
9006	1	H8503-9006

TIENDA



Sincronizador cierre Detroit

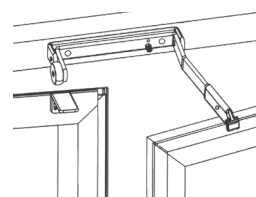
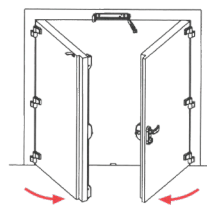
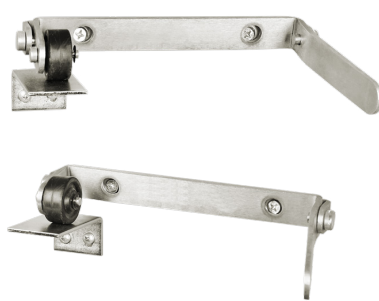

		REF.
Corto	1	H8506
Largo	1	H8507

TIENDA



Junta de expansión alta temperatura Rango de expansión 9-58mm



EXPANDE UNAS 10 VECES SU GROSOR A ALTAS TEMPERATURAS, EVITANDO ASÍ EL PASO DEL HUMO Y DE LAS LLAMAS.



GROSOR	M/ROLLO	REF.
1,5mm	15m	H8510
2mm	15m	H8512
1,5mm	20m	H8511
2mm	20m	H8513

TIENDA



Expositor antipánico Detroit

REF.

EXPOSITOR1

TIENDA



Parte delantera

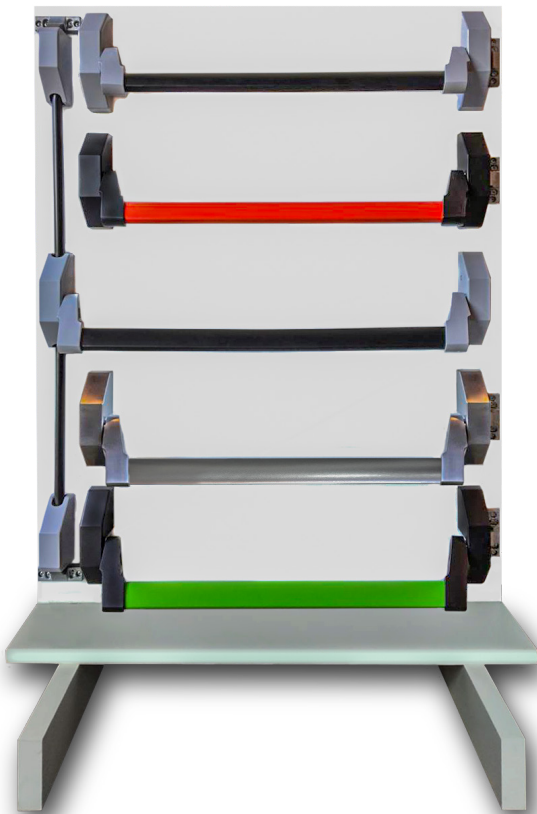

Parte trasera





Panamá - Kit antipánico

	DESCRIPCIÓN		REF.
1	Kit antipánico Panamá 1 punto cierre	-	AP8804-OLTRE
1	Kit antipánico Panamá 1 punto cierre	Plata	AP8804-PLATA
1	Kit antipánico Panamá 2 puntos cierre	-	AP8805-OLTRE
1	Kit antipánico Panamá 2 puntos cierre	Plata	APP8805-PLATA
1	Manilla ext. con llave	Negro	88896

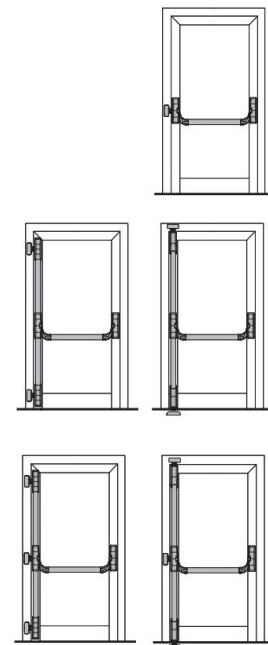
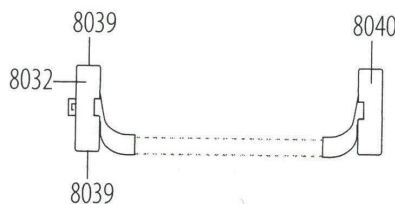

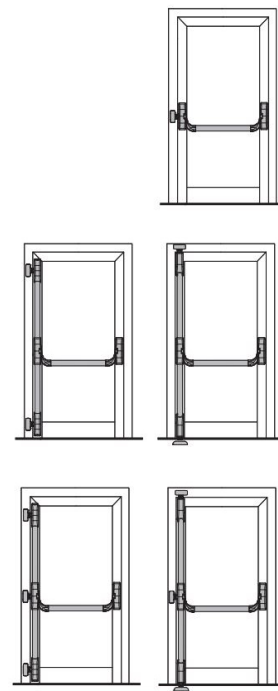
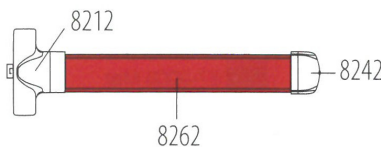
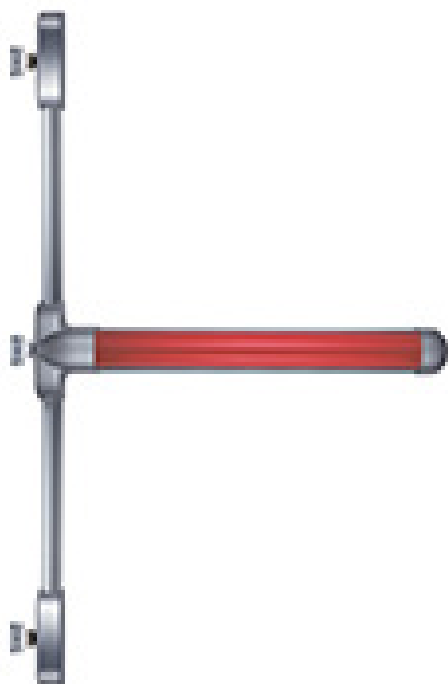

Push - Kit antipánico

	DESCRIPCIÓN		REF.
1	Kit antipánico Push 1 punto cierre	-	AP8821-PUSH
1	Kit antipánico Push 2 puntos cierre	-	AP8822-PUSH
1	Manilla ext. con llave	Negro	88896



Kit antipánico

	DESCRIPCIÓN		REF.
1	Kit antipánico 1ª hoja	-	92283
1	Kit antipánico 2ª hoja	-	92284
1	Manilla ext. con llave	Negro	92285





TIENDA



Manilla exterior con cilindro



		REF.
1	Negro	88896

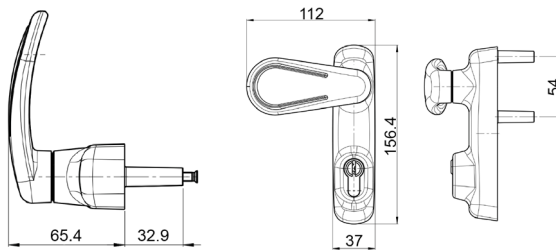



TIENDA



Sincronizador de cierre de antipánico



		REF.
5	Negro	92622

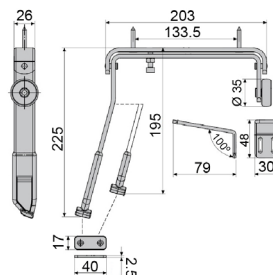

TIENDA





Video de
presentación

Häusen[®]
Accesorios para puertas y ventanas

CERRADURA AUTOMÁTICA

DOMO

PVC / ALU C-16

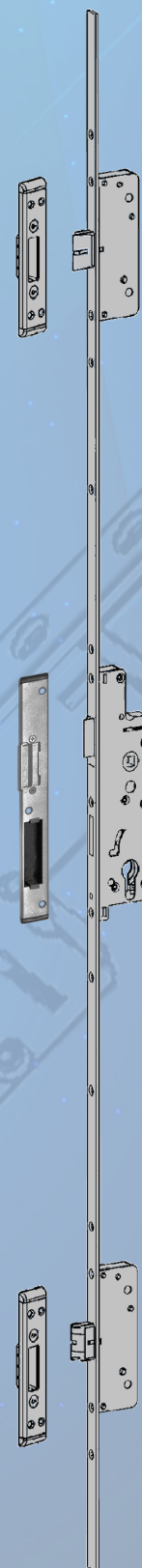

Cerradura automática "Domo"



POSICIÓN ABIERTA

POSICIÓN CERRADA

POSICIÓN BLOQUEO

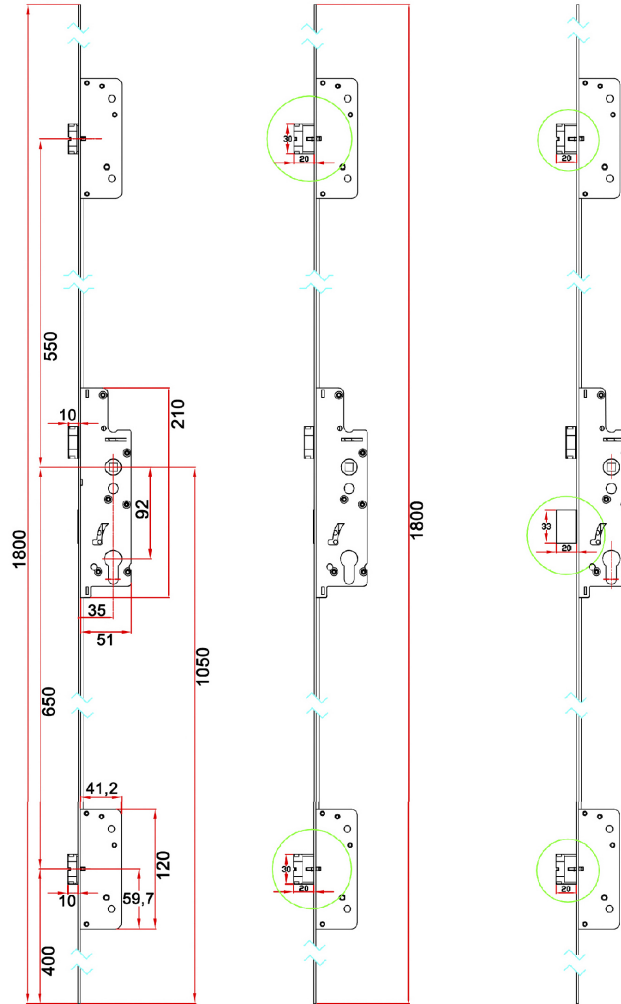

Cambiar la orientación del perno central del pestillo automático

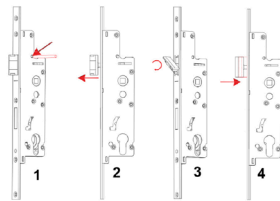

- 1- Empuje el pasador de liberación del perno con ajuste de 4,5 mm
- 2- A medida que se empuja el pasador de liberación, se soltará el perno
- 3- Gire el pestillo para que el lado curvo del pestillo se invierta
- 4- Coloque el pestillo invertido de nuevo en la unidad de bloqueo

Cambiar la orientación del perno del pestillo automático

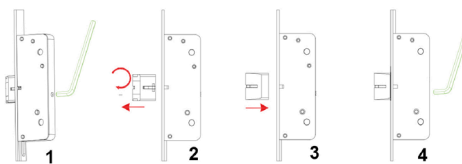

- 1- Como la cerradura automática tiene una posición de 20mm, suelte el pestillo girando el tornillo de ajuste con una llave Allen AA4
- 2- Gire el pestillo para que el lado curvo del pestillo se invierta
- 3- Coloque el pestillo invertido de nuevo en la transmisión del perno
- 4- Fije el pestillo con el tornillo de ajuste usando la llave Allen AA4

📦	DESCRIPCIÓN	EJE	🔧	REF.
10	Cerradura automática derecha	92/35mm	2.000mm	P2888
10	Cerradura automática izquierda	92/35mm	2.000mm	P2889
50	Cerradero central de PVC derecho	-	13mm	P2885
50	Cerradero central de PVC izquierdo	-	13mm	P2886
50	Cerradero de PVC superior / inferior	-	13mm	P2887

TIENDA



Cerraduras 3 puntos leva y bulones seguridad

Frente plano acero inox (agujas 25, 30 y 35)

SOLO CERRADURA	CERRADURA + 30x30 NOR.	CERRADURA + 30x40 NOR.	CERRADURA + 30x30 SEG.	CERRADURA + 30x40 SEG.
L8825	K8175	K8185	K8195	K8205
L8830	K8176	K8186	K8196	K8206
L8835	K8177	K8187	K8197	K8207

TIENDA



Frente "U" de aluminio (agujas 25, 30 y 35)

SOLO CERRADURA	CERRADURA + 30x30 NOR.	CERRADURA + 30x40 NOR.	CERRADURA + 30x30 SEG.	CERRADURA + 30x40 SEG.
L8725	K8170	K8180	K8190	K8200
L8730	K8171	K8181	K8191	K8201
L8735	K8172	K8182	K8192	K8202

Frente plano

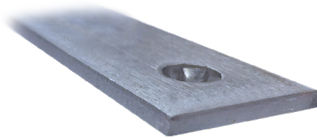

Frente "U"

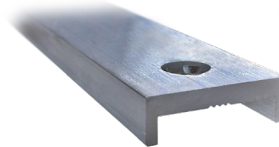

Acople de rodillo

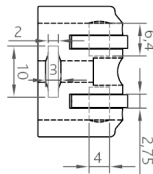

25

REF.

H7023

TIENDA



Frente plano acero inox (agujas 25, 30 y 35)

TIENDA



SOLO CERRADURA	CERRADURA + 30x30 NOR.	CERRADURA + 30x40 NOR.	CERRADURA + 30x30 SEG.	CERRADURA + 30x40 SEG.
L8625	K8150	K8155	K8160	K8165
L8630	K8151	K8156	K8161	K8166
L8635	K8152	K8157	K8162	K8167

Cerradura Performa

	MODELO	FRENTE	AGUJA	REF.
1	72350	PLANO	25	94590
1	72350	PLANO	30	94588
1	72350	PLANO	35	94589
1	72355	"U"	25	94651
1	72355	"U"	30	92851
1	72355	"U"	35	92852

TIENDA

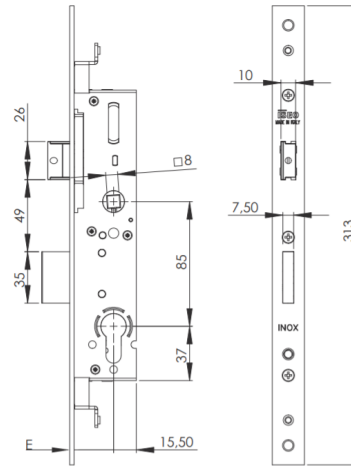

Cerradero Performa

POSICIÓN		REF.
CENTRAL	1	94591
SUP/INF	1	94592

TIENDA



Acople de rodillo para Performa

	REF.
1	94594

TIENDA



Cerradura 1 punto aluminio con conexiones C.E.

Con conexiones en los extremos

INTEREJE	AGUJA		REF.
85	25	1	P2459
85	28	1	P2460
85	35	1	P2461
92	25	1	P2456
92	28	1	P2457
92	35	1	P2458

TIENDA



Bloqueada

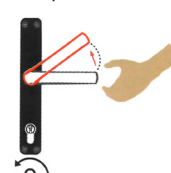

Para bloquear

Abierta

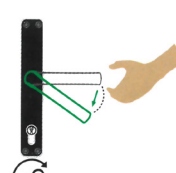

Para desbloquear

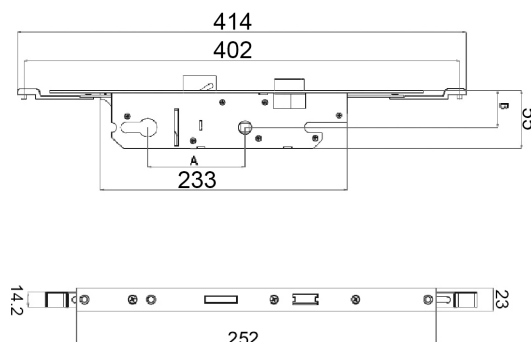

Häusen®

Cerradura aluminio con resbalón y pestillo deslizante

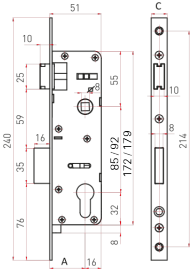
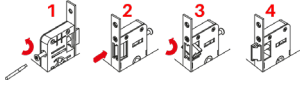

	AGUJA	FRENTE			REF.	
	85mm	20	16	40	23,00	P2450
	85mm	25	16	40	23,00	P2451
	85mm	30	16	40	23,00	P2452
	85mm	35	16	40	23,00	P2453

TIENDA



MARK

Cerradura con resbalón y pestillo deslizante

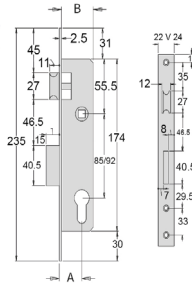
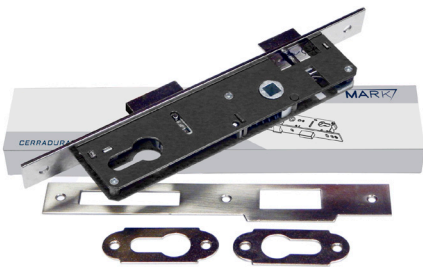

	AGUJA	FRENTE				REF.	
	85mm	25	22	30	390 x 135 x 165	14,30	M8125
	85mm	30	22	30	390 x 135 x 165	14,30	M8130
	85mm	35	22	30	390 x 135 x 165	14,30	M8135

TIENDA



MARK

Cerradura con resbalón y pestillo basculante

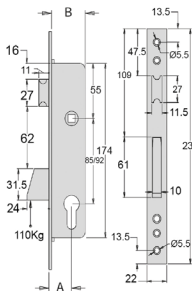

	AGUJA	FRENTE				REF.	
	85mm	25	22	30	390 x 135 x 165	16,00	M8225
	85mm	30	22	30	390 x 135 x 165	16,00	M8230
	85mm	35	22	30	390 x 135 x 165	16,00	M8235

TIENDA



MARK

Cerradura de zócalo

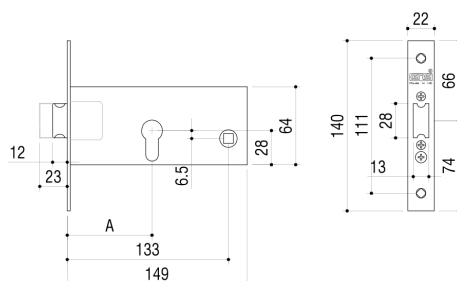



A			REF.
70mm	50	23,00	L8170

TIENDA



Cilindro níquel llave normal



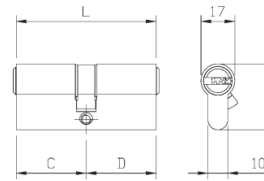

	LEVA	LL/IGUAL		REF.
30x30	15	No	10	M8200
30x40	15	No	10	M8201
30x30	15	Si	10	M8204
30x40	15	Si	10	M8205
30x50	15	No	10	M8209
30x60	15	No	10	M8210
30x70	15	No	10	M8211
40x50	15	No	10	M8212
45x50	15	No	10	M8207
50x55	15	No	10	M8208
30x30	13,25	No	10	M8223
30x40	13,25	No	10	M8224

TIENDA



Cilindro llave normal con pomo



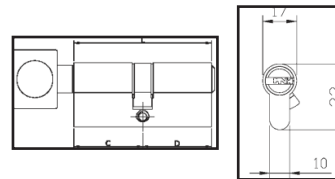

	LEVA	LL/IGUAL		REF.
40x40	15	-	10	L8106

TIENDA



Cilindro llave seguridad



	LEVA	LL/IGUAL		REF.
30x30	15	-	10	M8110
30x40	15	-	10	M8111
30x50	15	-	10	M8219
30x60	15	-	10	M8220
30x70	15	-	10	M8221
45x50	15	-	10	M8215
50x55	15	-	10	M8218

TIENDA

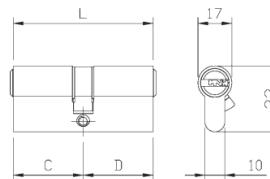

Cilindro llave seguridad con pomo



	LEVA	LL/IGUAL		REF.
40x40	15	-	10	L8114

TIENDA

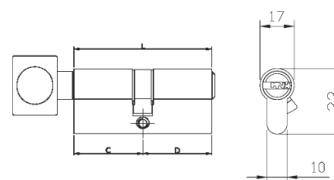



Conjuntos cerradura deslizante + cilindro



TIENDA



COMPONENTES	REF.
J4123 / 30+30	K8006
L8125 / 30+30	K8000
L8130 / 30+30	K8002
J4133 / 30+30	K8008
L8135 / 30+30	K8004
J4123 / 30+40	K8007
L8125 / 30+40	K8001
L8130 / 30+40	K8003
J4133 / 30+40	K8009
L8135 / 30+40	K8005



Conjuntos cerradura basculante + cilindro



TIENDA



COMPONENTES	REF.
L8225 / 30+30 NORMAL	K8010
L8230 / 30+30 NORMAL	K8011
L8235 / 30+30 NORMAL	K8012
L8125 / 30+40 NORMAL	K8015
L8230 / 30+40 NORMAL	K8016
L8235 / 30+40 NORMAL	K8017
L8225 / 30+30 SEGURIDAD	K8020
L8230 / 30+30 SEGURIDAD	K8021
L8235 / 30+30 SEGURIDAD	K8022
L8225 / 30+40 SEGURIDAD	K8025
L8230 / 30+40 SEGURIDAD	K8026
L8235 / 30+40 SEGURIDAD	K8027



Cerradura deslizante leva corta



TIENDA



AGUJA			REF.
23	25	23,00	J4123
33	25	23,00	J4133

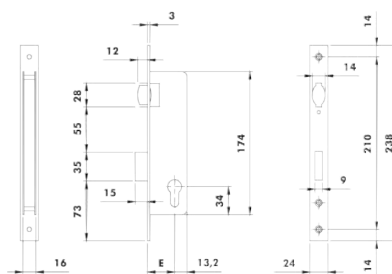

Cerradura 740/28 deslizante leva corta





TIENDA

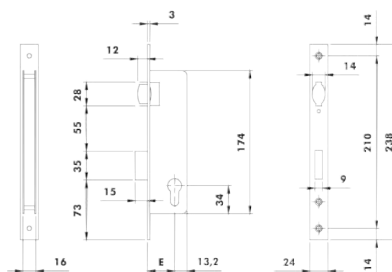

AGUJA			REF.
28	25	23,00	62304



Cerradura 741 deslizante con resbalón

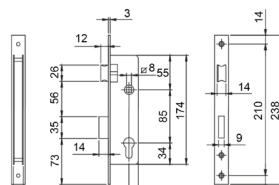

MODELO	AGUJA			REF.
741	20	No	25	85251
741	20	30x30	25	53245
741	25	No	25	53794
741	25	30x30	25	53696
741	30	No	25	62301
741	30	30x30	25	62308
741	35	No	25	62302
741	35	30x30	25	62309
741	35	30x40	25	62253



TIENDA



Cerradura 743 deslizante con rodillo

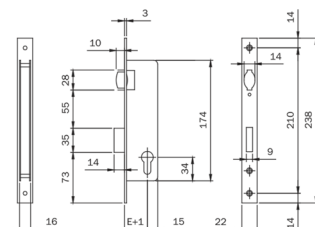

MODELO	AGUJA			REF.
743	25	No	25	53959
743	25	30x30	25	92265
743	30	No	25	53244
743	30	30x30	25	95027
743	35	No	25	94797
743	35	30x30	25	85252



TIENDA



Cerradura 745 deslizante frente níquel sin resbalón

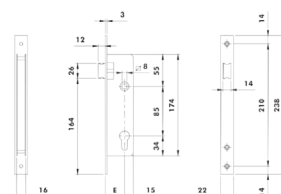

MODELO	AGUJA			REF.
745	25	No	25	62385
745	30	No	25	94727
745	35	No	25	94725



TIENDA



Cerradura 749 solo resbalón

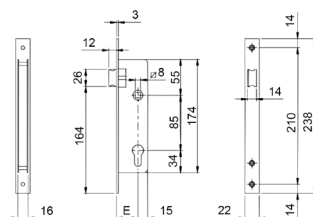

MODELO	AGUJA			REF.
749	20	No	25	30526
749	25	No	25	30527
749	25	30x10	25	62083
749	30	No	25	62177
749	30	30x10	25	62455
749	35	No	25	95028
749	35	30x10	25	85253



TIENDA



Cerradura 74157 de gancho con resbalón

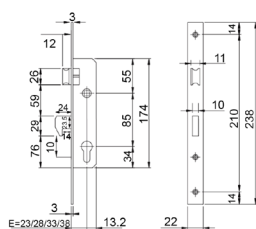

MODELO	AGUJA			REF.
74157	23	No	25	53967
74157	23	30x30	25	54112
74157	28	No	25	92921
74157	28	30x30	25	62342
74157	33	No	25	54114
74157	33	30x40	25	92289



TIENDA





Cerradura 762 solo resbalón

MODELO	AGUJA			REF.
762	15	No	10	92969

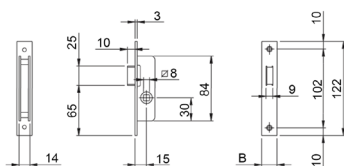
TIENDA



Cerradura 764 solo rodillo

MODELO	AGUJA			REF.
764	-	No	10	94458

TIENDA

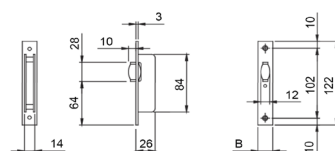

Cilindro R9 níquel anti-taladro + antibumping

	LEVA	LL/IGUAL		REF.
30x30	Larga	-	1	94801
30x40	Larga	-	1	86035
30x50	Larga	-	1	92941
30x60	Larga	-	1	86036
30x70	Larga	-	1	86037
40x40	Larga	-	1	86038
40x50	Larga	-	1	86039
50x50	Larga	-	1	86040

TIENDA



- 1 - Pernos de acero para control de la marca registrada.
- 2 - Pistones inferiores y laterales de acero.
- 3 - Protección de acero anti-taladro en el cuerpo del cilindro y del rotor.
- 4 - Barra anti-rotura de acero armonico.
- 5 - Codificación en 3 filas con pistones de acero.
- 6 - Desarrollado sobre perfiles individuales y reservados.

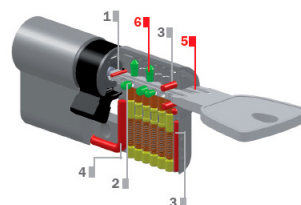

Cilindro F5 níquel llave normal leva larga

	LEVA	LL/IGUAL		REF.
30x30	Larga	No	10	62306
30x40	Larga	No	10	62307
30x50	Larga	No	10	62105
30x60	Larga	No	10	96263
30x70	Larga	No	10	62330
30x30	Larga	Si	10	54109
30x40	Larga	Si	10	62423
30x50	Larga	Si	10	62106
30x60	Larga	Si	10	62765
30x70	Larga	Si	10	94563

TIENDA

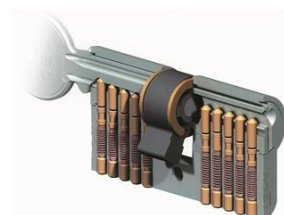

Cilindro F5 níquel llave normal leva corta

	LEVA	LL/IGUAL		REF.
30x30	Corta	No	10	62305
30x40	Corta	No	10	62329
30x50	Corta	No	10	95436
30x60	Corta	No	10	96267
30x70	Corta	No	10	92991
30x30	Corta	Si	10	99401
30x40	Corta	Si	10	99402
30x50	Corta	Si	10	96269
30x60	Corta	Si	10	92281

TIENDA



ISEO

Cilindro R6 níquel llave seguridad leva larga



	LEVA	LL/IGUAL		REF.
30x30	Larga	No	10	54113
30x40	Larga	No	10	62397
30x50	Larga	No	10	62396
30x60	Larga	No	10	95277
30x70	Larga	No	10	96307
40x60	Larga	No	10	96265
30x30	Larga	Si	10	96535
30x40	Larga	Si	10	95026
30x50	Larga	Si	10	96266
30x60	Larga	Si	10	96308
30x70	Larga	Si	10	95339
40x60	Larga	Si	10	92546

TIENDA



ISEO

Cilindro R6 níquel llave seguridad leva corta

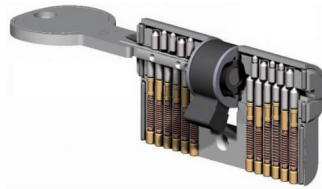

	LEVA	LL/IGUAL		REF.
30x30	Corta	No	10	95255
30x40	Corta	No	10	53294
30x50	Corta	No	10	92934
30x60	Corta	No	10	92626
30x30	Corta	Si	10	92305
30x40	Corta	Si	10	94567
30x50	Corta	Si	10	95751
30x60	Corta	Si	10	92304

TIENDA



Cerradura eléctrica

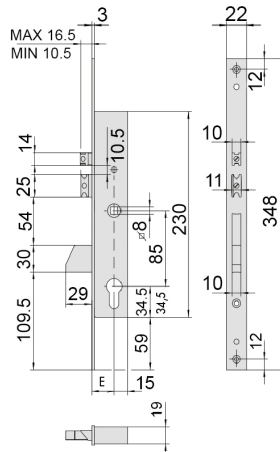
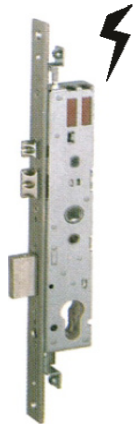

	MODELO		REF.
	16125/25	1	96542
	16125/30	1	62171
	16125/35	1	96583
ISEO	7818/25	1	95681
ISEO	7818/30	1	62382
ISEO	7818/35	1	62436

- Picaporte y palanca basculante
- Picaporte y pitón de recarga regulables de 10,5 a 16,5 mm
- Cerradero en acero inox. ref. 06462.01 (sólo en cerraduras con entrada 25 mm.). Cerraduras con entradas 30 y 35 mm. sin cerradero

TIENDA



Acople de rodillos

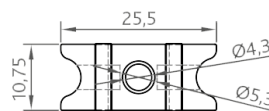
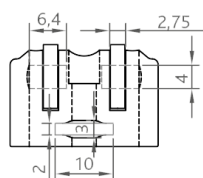



	REF.
25	H7023

TIENDA





Acople de cerradura

	LEVA		REF.
50	Corta	6mm	92627
50	Larga	6mm	92628

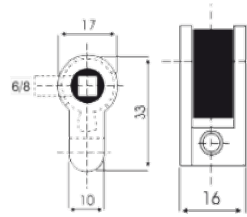
TIENDA



Muletilla



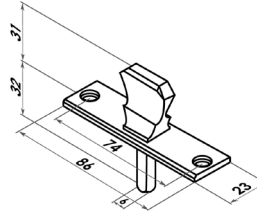

	RAL		REF.
50	9016	6mm	J1023-9016
50	9005	6mm	J1023-9005
50	9006	6mm	J1023-9006



TIENDA



Cuadrillos

				REF.
100	7mm	115mm	0,50	H7007
10	8mm	150mm	0,70	98704
10	8mm	150mm	0,70	98076

TIENDA

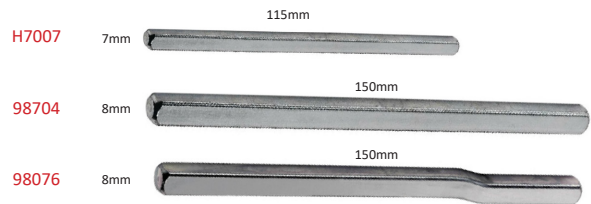

Seal - Cerradura bloqueo de ventanas C.E.

		REF:
20	Blanco	Z0028-9016
20	Negro	Z0028-9005



Lado de la manilla

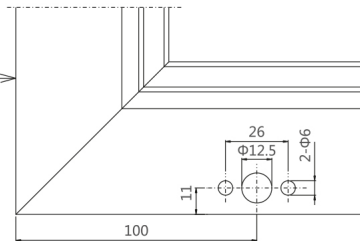

C.E.



TIENDA



Cerradero inox sup/inf 138,3mm regulable C. E.

			REF.
50	20,3mm	138,3mm	J6029



TIENDA

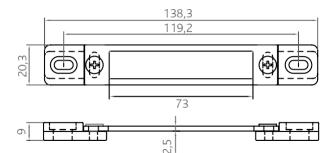

C.E.



Cerradero regulable C.E.

			REF.
50	20,3mm	191,8mm	J6028

TIENDA



C.E.

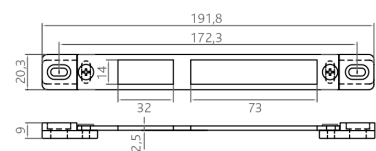

Kit de 3 cerraderos inox regulables C. E.

TIENDA

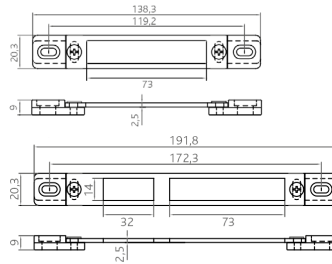

REF.
12 J6030

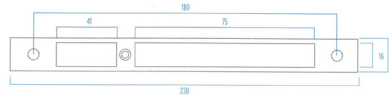
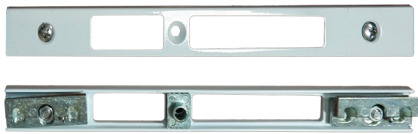

Cerradero cámara europea

TIENDA



TAMAÑO	RAL	REF.
50 Corto	9016	98876
50 Corto	9005	99097
50 Largo	9016	98877
50 Largo	9005	99031



Cerradero 40x20

TIENDA

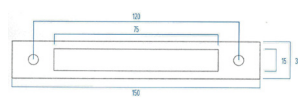

TAMAÑO	RAL	REF.
50 Corto	9016	99653
50 Corto	9005	99654
50 Largo	9016	96875
50 Largo	9005	99030



Atlas - Pasador de alta seguridad

Suave y extrafuerte, con un diseño moderno y discreto



Limitación de apertura

REF.
12 Marrón claro P9000-8003
12 Gris oscuro P9000-7016
12 Marrón P9000-8022
12 Negro P9000-9005
12 Blanco P9000-9016



TIENDA



Video demostración





ZENIT



Tecnología anti-bacterias

Cremona Yak con 2 palas.

		REF:
25	9016	Z0056-9016
25	9005	Z0056-9005
25	9006	Z0056-9006



TIENDA





ZENIT



Tecnología anti-bacterias

Cremona Yak con pala de "U".

		REF:
25	9016	Z0053-9016
25	9005	Z0053-9005
25	9006	Z0053-9006



TIENDA



ZENIT

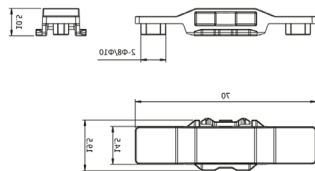

Conexión cremona Yak.

	REF:
20	Z0055

TIENDA



ZENIT

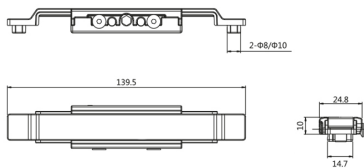



Conexión de manilla Joe.

	REF:
20	Z0000

TIENDA



Manilla Joe minimalista.



		REF:
25	9016	Z0001-9016
25	9005	Z0001-9005
25	9006	Z0001-9006



TIENDA



Manilla Joe con base.
Eje de 7mm.



		REF:
25	9016	Z0035-9016
25	9005	Z0035-9005
25	9006	Z0035-9006



TIENDA



Juego manilla Joe con escudo.

		REF:
25	9016	Z0045-9016
25	9005	Z0045-9005
25	9006	Z0045-9006



TIENDA



MANILLA MINIMALISTA KARINA

TIENDA



- P2392
BLANCO



- P2392
NEGRO



- P2392
PLATA

ARO KARINA

TIENDA



- P2394-9016



- P2394_9005



- P2394-NIQUEL

EJE CORONA CONEXIÓN KARINA

TIENDA



EJE CORONA KARINA 7X25 MM ALUC16
- P2374-ALUC16

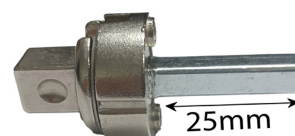

TIENDA



EJE CORONA KARINA 7X33 MM CORREDERA
- P2377-CORREDERA

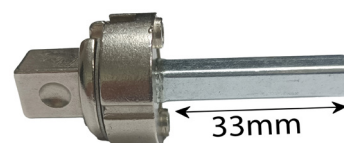

TIENDA



EJE CORONA KARINA 7X38 MM PVC
- P2379-PVC y ALUM. C.E.

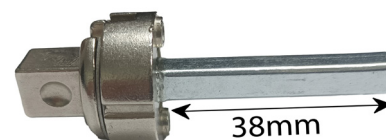

TIENDA



EJE CORONA KARINA 7X43 MM PVC
- P2349-PVC y ALUM. C.E.

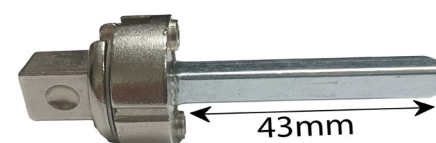

MANILLA MINIMALISTA KARINA

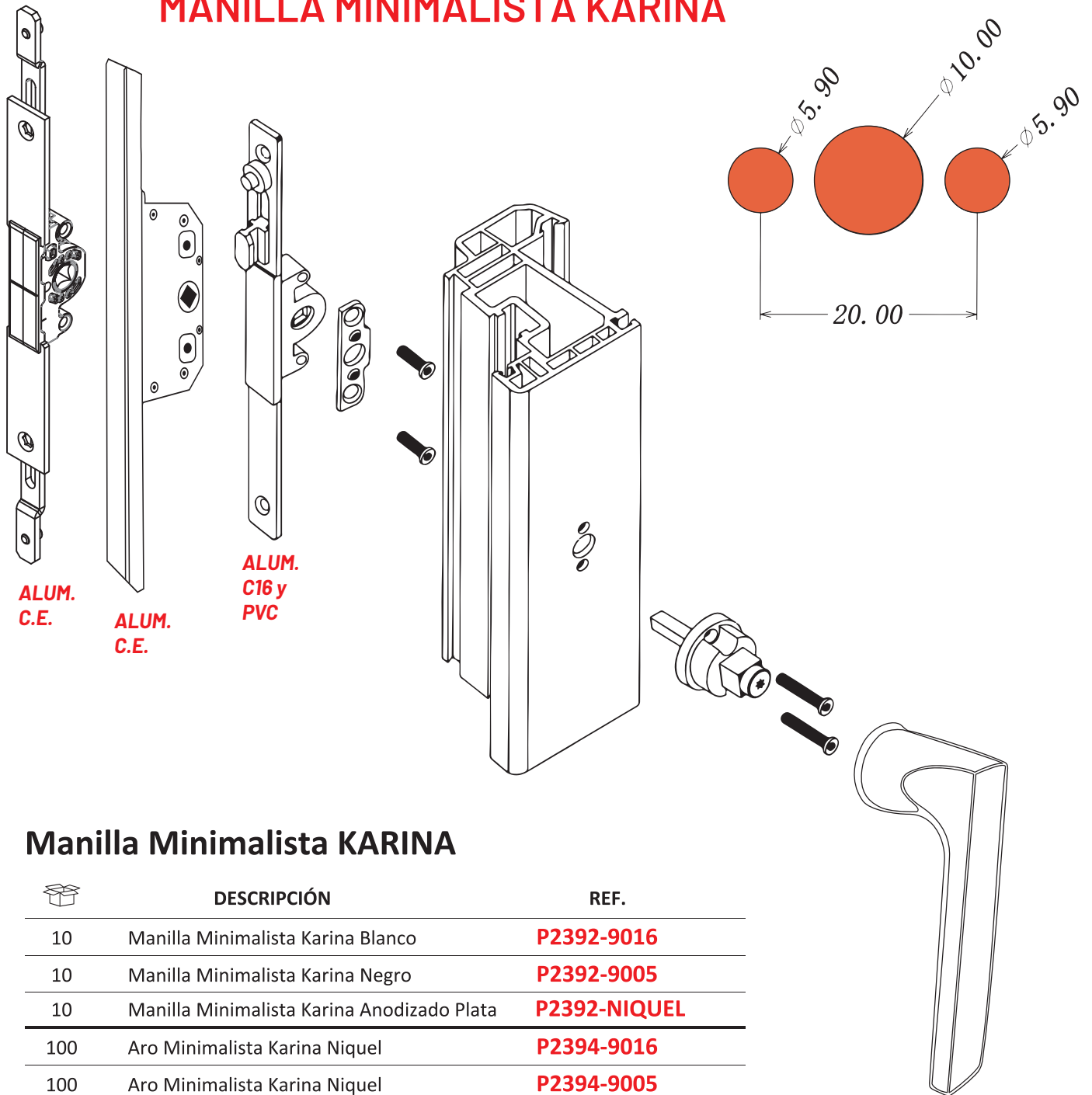

Manilla Minimalista KARINA

	DESCRIPCIÓN	REF.
10	Manilla Minimalista Karina Blanco	P2392-9016
10	Manilla Minimalista Karina Negro	P2392-9005
10	Manilla Minimalista Karina Anodizado Plata	P2392-NIQUEL
100	Aro Minimalista Karina Niquel	P2394-9016
100	Aro Minimalista Karina Niquel	P2394-9005
100	Aro Minimalista Karina Anodizado Plat a	P2394-NIQUEL
50	Eje Karina Aluminio Canal 16 (25 mm.)	P2374-ALUC16
50	Eje Karina Corredera (33 mm.)	P2377-CORREDERA
50	Eje Karina Pvc (37,5 mm.)	P2379-PVC
50	Eje Karina Pvc (43 mm.)	P2349-PVC
50	Adaptador Karina Mirror (20 mm)	P2504-PVC
50	Adaptador Karina Mirror (30 mm)	P2505-ALUC16
50	Adaptador Karina Mirror (35 mm)	P2506-CORREDERA



9016



9005



PLATA



9011
MATE



OXYDON



INOX





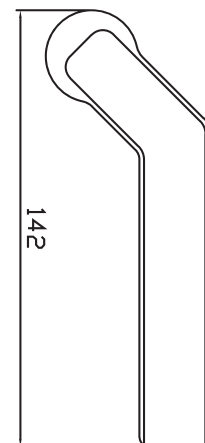
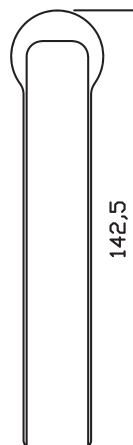
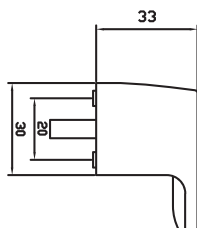
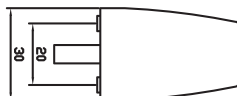

7016
TXT

MANILLA MINIMALISTA DESPLAZADA KARINA



Manilla Karina Desplazada

				ACCIÓN		REF.
50	385x185x240	9,5	NO	DER.	9016	P2371D-9016
50	385x185x240	9,5	NO	DER.	RAL	P2371D-9003
50	385x185x240	9,5	NO	DER.	9005	P2371D-9005
50	385x185x240	9,5	NO	IZQ.	9016	P2371I-9016
50	385x185x240	9,5	NO	IZQ.	RAL	P2371I-9003
50	385x185x240	9,5	NO	IZQ.	9005	P2371I-9005

TIENDA

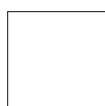

9016



9005



PLATA



9011
MATE



OXYDON



INOX



7016
TXT

ADAPTADOR MIRROR PARA PVC Y ALUM C16

1. Compatible con cualquier multipunto del mercado y medida.
2. Apto para todas las cremonas multipuntos del mercado, con todos sus diferentes ejes.
3. No necesita alterar el mecanizado inicial del cliente por su bajo espesor.
4. Su aleación especial nitrurada, le permite el efecto arandela "grover".
5. Una vez alojada la caja en el interior del perfil, se crea un triple bloqueo, formado junto con los tornillos alojados en el interior del cuerpo del eje, y los propios tornillos con sus arandelas grover.

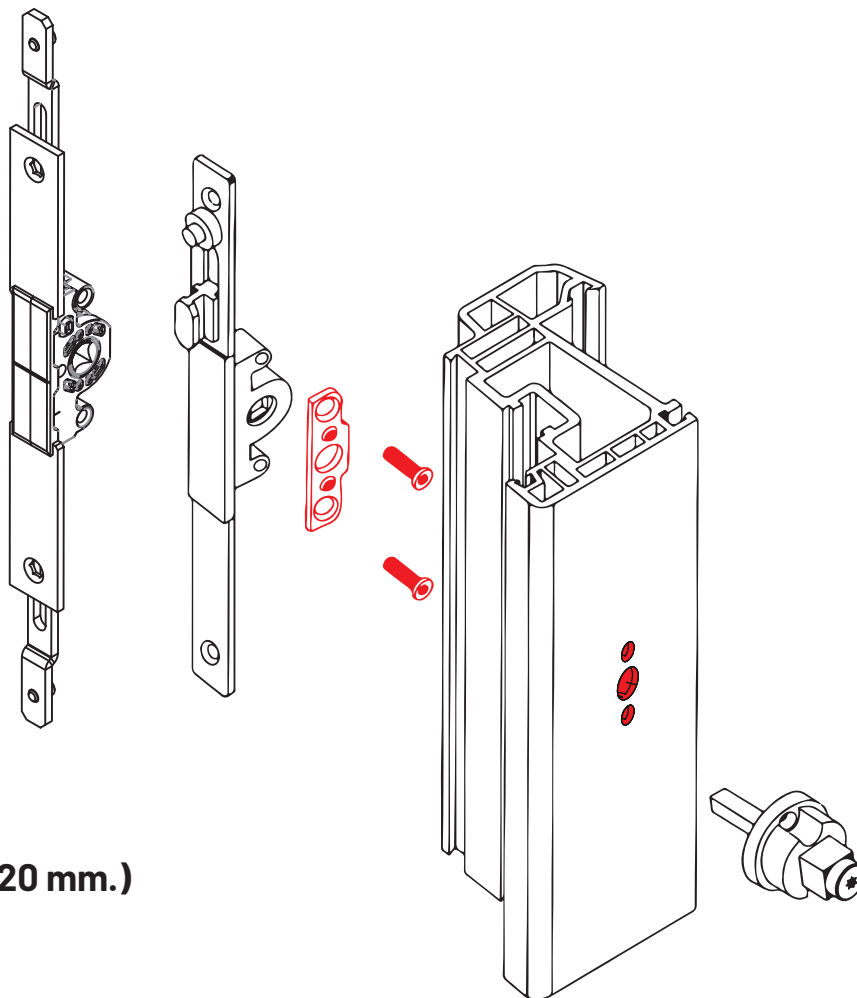

- **P2504**
(Tornillo de 4 x 20 mm.)
Aluminio C16.

- **P2505**
(Tornillo de 4 x 30 mm.)
PVC.

- **P2506**
(Tornillo de 4 x 35 mm.)
PVC.

COMPOSICIÓN SET/BOLSA



- Tornillo de 4 x 20 mm.
- Tornillo de 4 x 30 mm.
- Tornillo de 4 x 35 mm.





TIENDA



SERIE SOFIE

NUEVO

Manilla Sofie



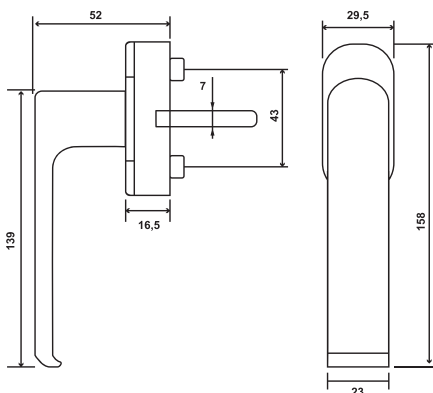

				ACCIÓN		REF.
50	385x185x240	9,5	NO	-	9016	P2363-9016
50	385x185x240	9,5	NO	-	9003	P2363-9003
50	385x185x240	9,5	NO	-	9005	P2363-9005
50	385x185x240	9,5	NO	-	9006	P2363-9006

TIENDA



NUEVO

Manilla plane Sofie

				ACCIÓN		REF.
100	385x185x240	12	NO	-	9016	P2343-9016
100	385x185x240	12	NO	-	9003	P2343-9003
100	385x185x240	12	NO	-	9005	P2343-9005



TIENDA

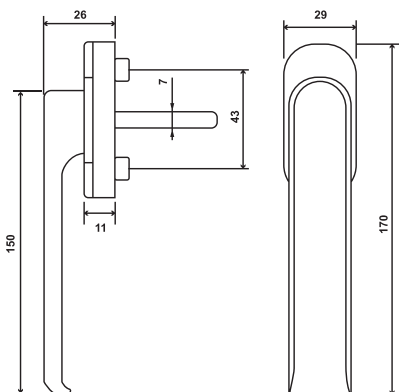

NUEVO

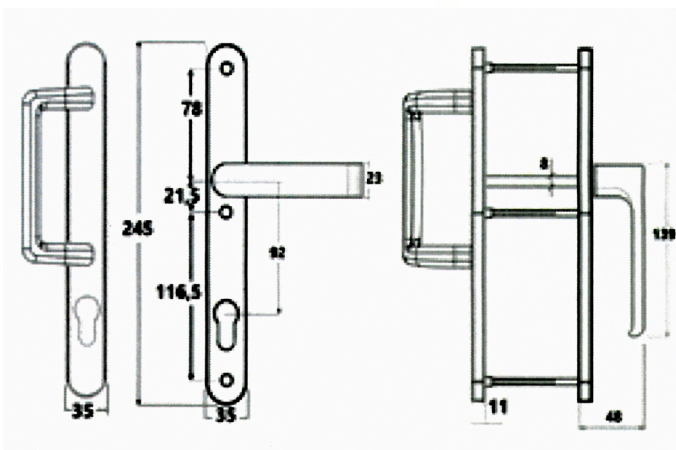

TIENDA



Manilla Sofie escudo + tirador 92/35

				INT.EJE		REF.
20	385 x 185 x 240	14,00	SI	92	9016	P2630-9016
20	385 x 185 x 240	14,00	SI	92	9005	P2630-9005
20	385 x 185 x 240	14,00	SI	92	9006	P2630-9006



Manilla Sofie escudo + tirador 92/28

TIENDA



				INT.EJE		REF.
20	385 x 185 x 240	14,00	SI	92	9016	P2636-9016
20	385 x 185 x 240	14,00	SI	92	9005	P2636-9005
20	385 x 185 x 240	14,00	SI	92	9006	P2636-9006



NUEVO

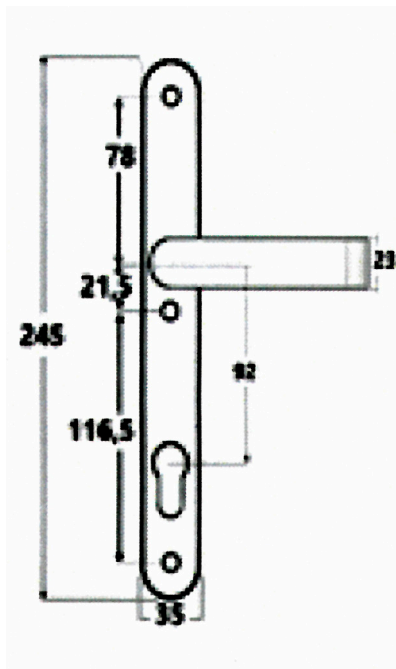

Manilla Sofie escudo + placa ciega 92/35

TIENDA



				INT.EJE		REF.
20	385 x 185 x 240	14,00	SI	92	9016	P2634-9016
20	385 x 185 x 240	14,00	SI	92	9005	P2634-9005
20	385 x 185 x 240	14,00	SI	92	9006	P2634-9006



Manilla Sofie escudo + placa ciega 92/28

TIENDA



				INT.EJE		REF.
20	385 x 185 x 240	14,00	SI	92	9016	P2629-9016
20	385 x 185 x 240	14,00	SI	92	9005	P2629-9005
20	385 x 185 x 240	14,00	SI	92	9006	P2629-9006



NUEVO

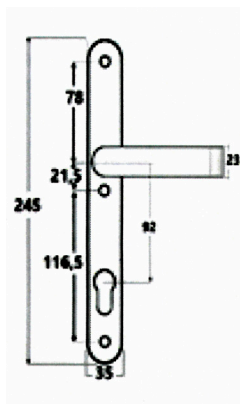

Manilla Sofie escudo + plane 92/35

				INT. EJE		REF.
20	385 x 185 x 240	14,00	SI	92	9016	P2631-9016
20	385 x 185 x 240	14,00	SI	92	9005	P2631-9005
20	385 x 185 x 240	14,00	SI	92	9006	P2631-9006



TIENDA



Manilla Sofie escudo + plane 85/35

				INT. EJE		REF.
20	385 x 185 x 240	14,00	SI	85	9016	P2633-9016
20	385 x 185 x 240	14,00	SI	85	9005	P2633-9005
20	385 x 185 x 240	14,00	SI	85	9006	P2633-9006



TIENDA



Manilla Sofie escudo + plane 92/28

				INT. EJE		REF.
20	385 x 185 x 240	14,00	SI	92	9016	P2637-9016
20	385 x 185 x 240	14,00	SI	92	9005	P2637-9005
20	385 x 185 x 240	14,00	SI	92	9006	P2637-9006



TIENDA



Manilla Sofie escudo + plane 85/28

				INT. EJE		REF.
20	385 x 185 x 240	14,00	SI	85	9016	P2638-9016
20	385 x 185 x 240	14,00	SI	85	9005	P2638-9005
20	385 x 185 x 240	14,00	SI	85	9006	P2638-9006



TIENDA



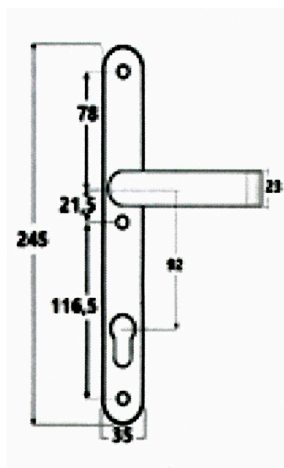

Manilla Sofie escudo doble 92/35

				INT. EJE		REF.
20	385 x 185 x 240	14,00	SI	92/35	9016	P2632-9016
20	385 x 185 x 240	14,00	SI	92/35	9005	P2632-9005
20	385 x 185 x 240	14,00	SI	92/35	9006	P2632-9006



TIENDA



Manilla Sofie escudo doble 85/35

				INT. EJE		REF.
20	385 x 185 x 240	14,00	SI	85	9016	P2635-9016
20	385 x 185 x 240	14,00	SI	85	9005	P2635-9005
20	385 x 185 x 240	14,00	SI	85	9006	P2635-9006



TIENDA



Manilla Sofie escudo doble 92/28

				INT. EJE		REF.
20	385 x 185 x 240	14,00	SI	92	9016	P2639-9016
20	385 x 185 x 240	14,00	SI	92	9005	P2639-9016
20	385 x 185 x 240	14,00	SI	92	9006	P2639-9016



TIENDA



Manilla Sofie escudo doble 85/28

				INT. EJE		REF.
20	385 x 185 x 240	14,00	SI	85	9016	P2640-9016
20	385 x 185 x 240	14,00	SI	85	9005	P2640-9016
20	385 x 185 x 240	14,00	SI	85	9006	P2640-9016



TIENDA



Häusen®



TIENDA

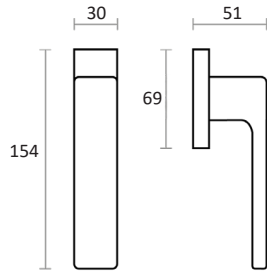

Manilla Spartan oscilo-batiente.

RAL				REF.
9016	2	1	-	P2355-9016
9005	2	1	-	P2355-9005
INOX	2	1	-	P2355-INOX



Häusen®



TIENDA

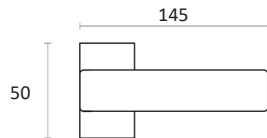

Juego manilla recuperable Spartan.

RAL				REF.
9016	2	1	-	P2356-9016
9005	2	1	-	P2356-9005
INOX	2	1	-	P2356-INOX



Häusen®



TIENDA

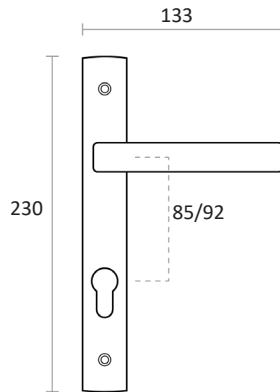

Juego manilla Spartan - escudo.

RAL			INTEREJE	REF.
9016	2	1	85X32	P2357-9016
9005	2	1	85X32	P2357-9005
INOX	2	1	85X32	P2357-INOX
9016	2	1	92X32	P2361-9016
9005	2	1	92X32	P2361-9005
INOX	2	1	92X32	P2361-INOX



Häusen®

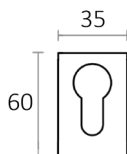

TIENDA



Cubrecilindros Spartan.

RAL				REF.
9016	2	1	-	P2360-9016
9005	2	1	-	P2360-9005
INOX	2	1	-	P2360-INOX

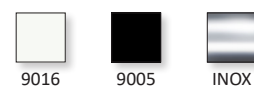

Manillón Spartan oscilo-paralela.



RAL				REF.
9016	2	1	-	P2362-9016
9005	2	1	-	P2362-9005
INOX	2	1	-	P2362-INOX

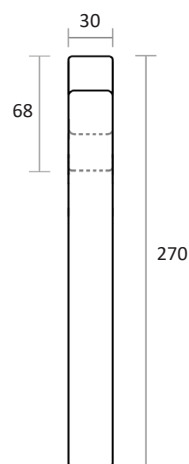

TIENDA



Manillón Spartan corredera-elevable.



RAL				REF.
9016	2	1	-	P2359-9016
9005	2	1	-	P2359-9005
INOX	2	1	-	P2359-INOX

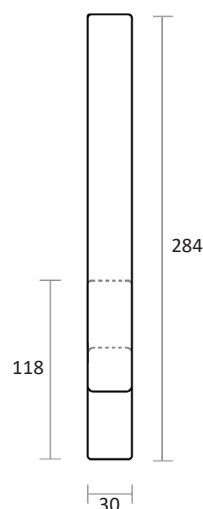

TIENDA





Uñero Spartan.

RAL				REF.
9016	2	1	-	P2358-9016
9005	2	1	-	P2358-9005
INOX	2	1	-	P2358-INOX

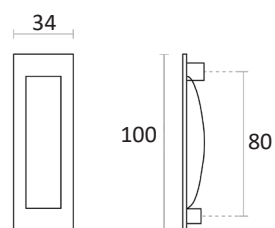
TIENDA



Cubrecilindros Spartan especial elevable.

RAL				REF.
9016	1	1	-	P2369-9016
9005	1	1	-	P2369-9005
INOX	1	1	-	P2369-INOX

TIENDA

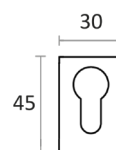

Häusen®

TIENDA

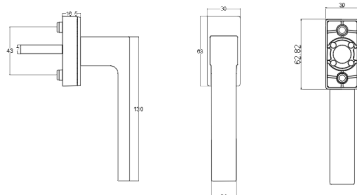

Manilla Corvair oscilo-batiente

					REF.
50	385 x 200 x 260	9,50	2	9016	P2380-9016
50	385 x 200 x 260	9,50	2	9006	P2380-9006
50	385 x 200 x 260	9,50	2	9005	P2380-9005
50	385 x 200 x 260	9,50	2	8022	P2380-8022



Häusen®

Manilla Corvair oscilo-batiente con llave



TIENDA



					REF.
50	590 x 388 x 250	13,18	2	9016	P2381-9016
50	590 x 388 x 250	13,18	2	9006	P2381-9006
50	590 x 388 x 250	13,18	2	9005	P2381-9005
50	590 x 388 x 250	13,18	2	8022	P2381-8022



Häusen®

Manilla Corvair acodada



IZQUIERDA

DERECHA

TIENDA



				MANO		REF.
50	580 x 380 x 220	17,87	2	Izqu.	9016	P2388-9016
50	580 x 380 x 220	17,87	2	Izqu.	9006	P2388-9006
50	580 x 380 x 220	17,87	2	Izqu.	9005	P2388-9005
50	580 x 380 x 220	17,87	2	Izqu.	8022	P2388-8022
50	580 x 380 x 220	17,87	2	Decha.	9016	P2389-9016
50	580 x 380 x 220	17,87	2	Decha.	9006	P2389-9006
50	580 x 380 x 220	17,87	2	Decha.	9005	P2389-9005
50	580 x 380 x 220	17,87	2	Decha.	8022	P2389-8022



Häusen®

Manilla Corvair oscilo-paralela

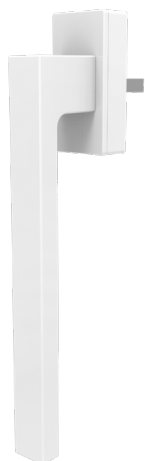





TIENDA



					REF.
20	385 x 295 x 215	8,65	2	9016	P2382-9016
20	385 x 295 x 215	8,65	2	9006	P2382-9006
20	385 x 295 x 215	8,65	2	9005	P2382-9005
20	385 x 295 x 215	8,65	2	8022	P2382-8022



Manilla Corvair con escudo

				INTEREJE		REF.
40	580 x 388 x 265	13,08	2	92mm	9016	P2384-9016
40	580 x 388 x 265	13,08	2	92mm	9006	P2384-9006
40	580 x 388 x 265	13,08	2	92mm	9005	P2384-9005
40	580 x 388 x 265	13,08	2	92mm	8022	P2384-8022
20	585 x 388 x 245	13,08	2	85mm	9016	P2385-9016
20	585 x 388 x 245	13,08	2	85mm	9006	P2385-9006
20	585 x 388 x 245	13,08	2	85mm	9005	P2385-9005
20	585 x 388 x 245	13,08	2	85mm	8022	P2385-8022

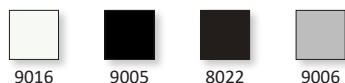





TIENDA



6 MUELLES DE PRESIÓN

Manilla Corvair con escudo y asa

					REF.
20	290 x 580 x 260	15,05	2	9016	P2386-9016
20	290 x 580 x 260	15,05	2	9006	P2386-9006
20	290 x 580 x 260	15,05	2	9005	P2386-9005
20	290 x 580 x 260	15,05	2	8022	P2386-8022

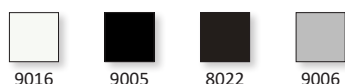



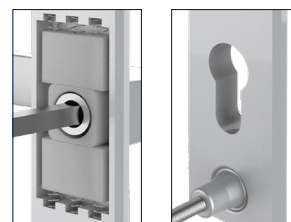

TIENDA



6 MUELLES DE PRESIÓN Y ESCUDO MACIZO



Manilla Corvair recuperable

					REF.
20	590 x 388 x 270	15,55	6	9016	P2383-9016
20	590 x 388 x 270	15,55	6	9006	P2383-9006
20	590 x 388 x 270	15,55	6	9005	P2383-9005
20	590 x 388 x 270	15,55	6	8022	P2383-8022

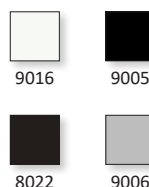





TIENDA

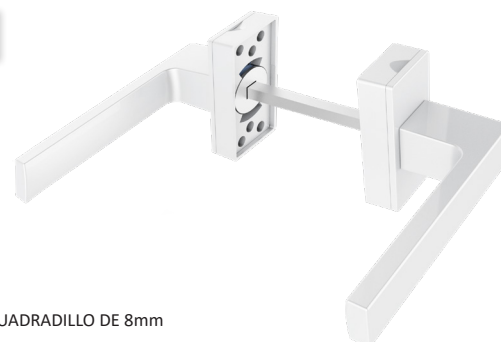

CON CUADRADILLO DE 8mm



Bocallave Corvair

					REF.
600	238 x 590 x 388	19,54	2	9016	P2387-9016
600	238 x 590 x 388	19,54	2	9006	P2387-9006
600	238 x 590 x 388	19,54	2	9005	P2387-9005
600	238 x 590 x 388	19,54	2	8022	P2387-8022

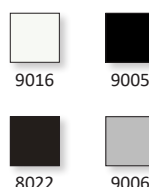

TIENDA



Häusen

Manilla Costa. Eje cuadradillo de 7mm.

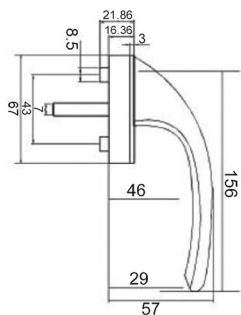

RAL				REF.
9016	2	10	3,40	P2302-9016
8022	2	10	3,40	P2302-8022
9005	2	10	3,40	P2302-9005
ELOXAL	2	10	3,40	P2302-ELOXAL
CROMO	2	10	3,40	P2302-CROMO
INOX	2	10	3,40	P2302-INOX



TIENDA



Häusen

Manilla Costa Exit. Eje cuadradillo de 7mm.

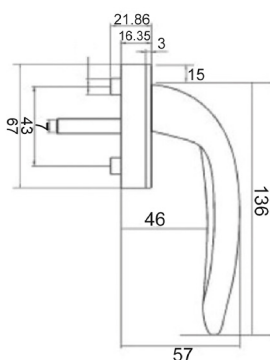

RAL				REF.
9016	2	40	19,00	P2340-9016
8019	2	40	19,00	P2340-8019
8022	2	40	19,00	P2340-8022
9005	2	40	19,00	P2340-9005
ELOXAL	2	40	19,00	P2340-ELOXAL
CROMO	2	40	19,00	P2340-CROMO

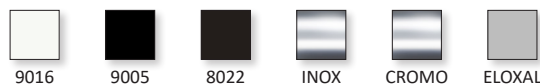

TIENDA



Häusen

Manilla Costa Exit - escudo. Eje cuadradillo de 8mm.

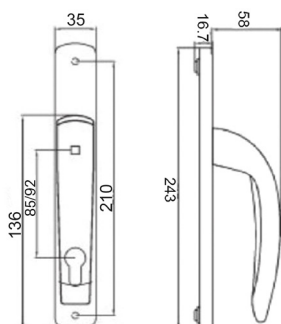

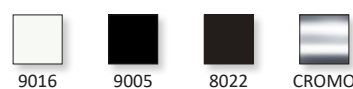

RAL				INTEREJE	REF.
9016	2	40	19,00	85x32	P2345-9016
8022	2	40	19,00	85x32	P2345-8022
9005	2	40	19,00	85x32	P2345-9005
CROMO	2	40	19,00	85x32	P2345-CROMO
9016	2	40	19,00	92x32	P2334-9016
8022	2	40	19,00	92x32	P2334-8022
9005	2	40	19,00	92x32	P2334-9005
CROMO	2	40	19,00	92x32	P2334-CROMO



TIENDA



Asa Capri doble con acción para multipunto

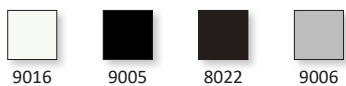

	ACCIÓN			REF.
50	Si	No	9016	P2230-9016
50	Si	No	9005	P2230-9005
50	Si	No	8022	P2230-8022
50	Si	No	9006	P2230-9006



TIENDA



Asa Capri doble sin acción para multipunto

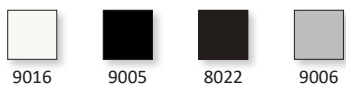

	ACCIÓN			REF.
50	No	No	9016	P2231-9016
50	No	No	9005	P2231-9005
50	No	No	8022	P2231-8022
50	No	No	9006	P2231-9006



TIENDA



Asa + uñero Capri con acción para multipunto

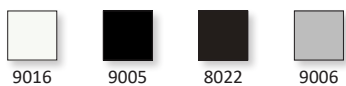

	ACCIÓN			REF.
50	Si	No	9016	P2232-9016
50	Si	No	9005	P2232-9005
50	Si	No	8022	P2232-8022
50	Si	No	9006	P2232-9006



TIENDA



Asa + uñero Capri sin acción para multipunto

	ACCIÓN			REF.
50	No	No	9016	P2233-9016
50	No	No	9005	P2233-9005
50	No	No	8022	P2233-8022
50	No	No	9006	P2233-9006

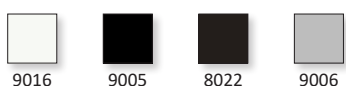

TIENDA





Häusen®

Asa bocallave Capri doble con acción para cerradura



TIENDA



	ACCIÓN			REF.
50	Si	Si	9016	P2234-9016
50	Si	Si	9005	P2234-9005
50	Si	Si	8022	P2234-8022
50	Si	Si	9006	P2234-9006





Häusen®

Asa bocallave Capri doble con acción para cerradura solo interior



TIENDA



	ACCIÓN			REF.
50	Si	Si	9016	P2235-9016
50	Si	Si	9005	P2235-9005
50	Si	Si	8022	P2235-8022
50	Si	Si	9006	P2235-9006





Häusen®

Asa escudo Capri doble con acción para cerradura solo interior



TIENDA



	ACCIÓN			REF.
50	Si	No	9016	P2236-9016
50	Si	No	9005	P2236-9005
50	Si	No	8022	P2236-8022
50	Si	No	9006	P2236-9006





Häusen®

Asa escudo Capri doble sin acción



TIENDA





	ACCIÓN			REF.
50	No	No	9016	P2237-9016
50	No	No	9005	P2237-9005
50	No	No	8022	P2237-8022
50	No	No	9006	P2237-9006



Asa bocallave + uñero largo Capri con acción para cerradura

Häusen®

	ACCIÓN			REF.
50	Si	Si	9016	P2238-9016
50	Si	Si	9005	P2238-9005
50	Si	Si	8022	P2238-8022
50	Si	Si	9006	P2238-9006

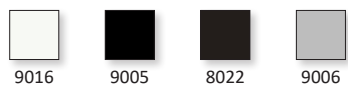



TIENDA



Asa escudo + uñero largo Capri con acción

Häusen®

	ACCIÓN			REF.
50	Si	No	9016	P2239-9016
50	Si	No	9005	P2239-9005
50	Si	No	8022	P2239-8022
50	Si	No	9006	P2239-9006

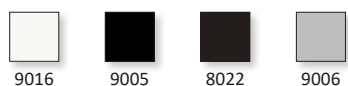



TIENDA



Asa escudo + uñero largo Capri sin acción

Häusen®

	ACCIÓN			REF.
50	Si	No	9016	P2240-9016
50	Si	No	9005	P2240-9005
50	Si	No	8022	P2240-8022
50	Si	No	9006	P2240-9006

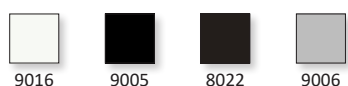



TIENDA



Uñero largo Capri doble

Häusen®

	ACCIÓN			REF.
50	No	No	9016	P2241-9016
50	No	No	9005	P2241-9005
50	No	No	8022	P2241-8022
50	No	No	9006	P2241-9006

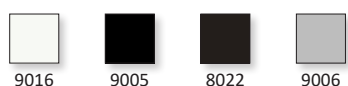

TIENDA



Häusen®

TIENDA



Manilla Danubio

Eje cuadradillo de 7mm

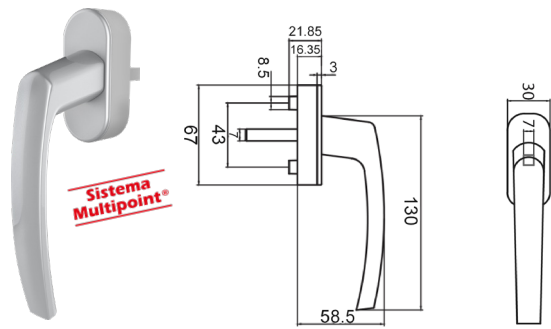

RAL				REF.
9016	2	100	19,00	P2320-9016
8019	2	100	19,00	P2320-8019
8022	2	100	19,00	P2320-8022
9005	2	100	19,00	P2320-9005
ORO	2	100	19,00	P2320-ORO
BRONCE	2	100	19,00	P2320-BRONCE
CROMO	2	100	19,00	P2320-CROMO



Häusen®

TIENDA



Manilla Danubio con llave

Eje cuadradillo de 7mm

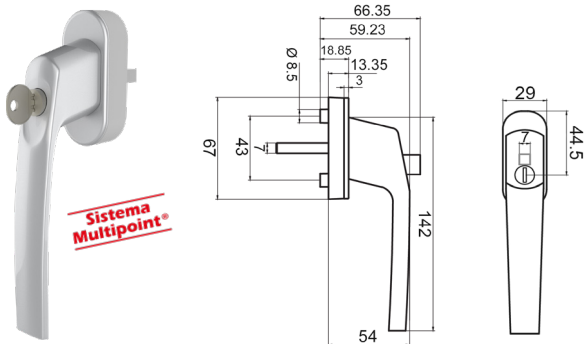

RAL				REF.
9016	2	50	11,75	P2304-9016
8022	2	50	11,75	P2304-8022
9005	2	50	11,75	P2304-9005
BRONCE	2	50	11,75	P2304-BRONCE
CROMO	2	50	11,75	P2304-CROMO



Häusen®

TIENDA



Manilla Danubio Slide



		MANO		REF.
50	2	Izquierda	9016	P2348I-9016
50	2	Izquierda	9005	P2348I-9005
50	2	Derecha	9016	P2348D-9016
50	2	Derecha	9005	P2348D-9005



Häusen®

TIENDA



Manilla Danubio doble

Eje cuadradillo de 7mm

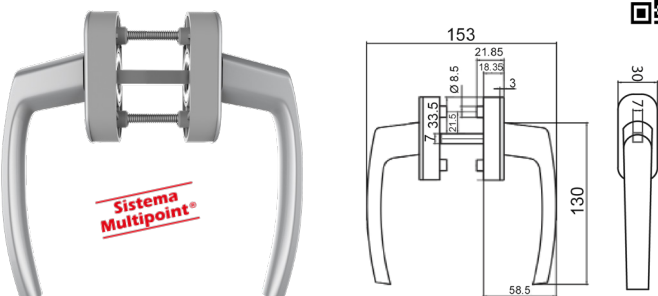



RAL				REF.
9016	2	50	19,15	P2325-9016
8019	2	50	19,15	P2325-8019
8022	2	50	19,15	P2325-8022
9005	2	50	19,15	P2325-9005
ORO	2	50	19,15	P2325-ORO
BRONCE	2	50	19,15	P2325-BRONCE
CROMO	2	50	19,15	P2325-CROMO



Manilla Danubio doble con llave

Eje cuadradillo de 7mm

RAL				REF.
9016	2	25	19,15	P2326-9016
8022	2	25	19,15	P2326-8022
9005	2	25	19,15	P2326-9005



9016 9005 8022

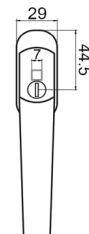
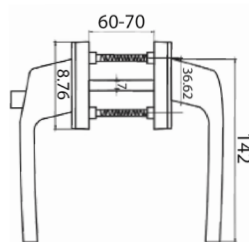





TIENDA



Häusen®

Manilla Gran Danubio

Eje cuadradillo de 7mm

RAL					REF.
9016	2	50	24,75	590x400x280	P2322-9016
8022	2	50	24,75	590x400x280	P2322-8022
9005	2	50	24,75	590x400x280	P2322-9005
9006	2	50	24,75	590x400x280	P2322-9006
CROMO	2	50	24,75	590x400x280	P2322-CROMO

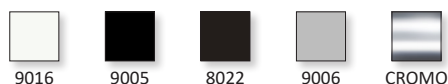

9016 9005 8022 9006 CROMO

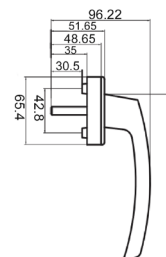
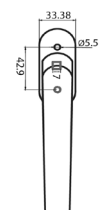





TIENDA



Häusen®

Manilla Gran Danubio doble

Eje cuadradillo de 7mm

RAL					REF.
9016	2	25	25,20	590x400x280	P2323-9016
8022	2	25	25,20	590x400x280	P2323-8022
9005	2	25	25,20	590x400x280	P2323-9005



9016 9005 8022

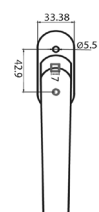
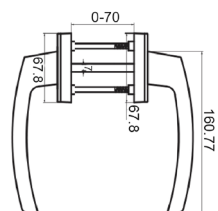



TIENDA



Häusen®

Manilla Danubio con escudo

Eje cuadradillo de 7mm

RAL			INTEREJE	REF.
9016	2	40	85x26	P2346-9016
9005	2	40	85x26	P2346-9005
CROMO	2	40	85x26	P2346-CROMO
9016	2	40	92X26	P2306-9016
8022	2	40	92x26	P2306-8022
9005	2	40	92X26	P2306-9005
CROMO	2	40	92X26	P2306-CROMO



9016 9005 8022 CROMO

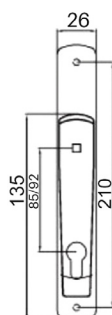

TIENDA

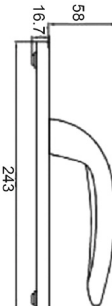

Häusen®

Häusen®

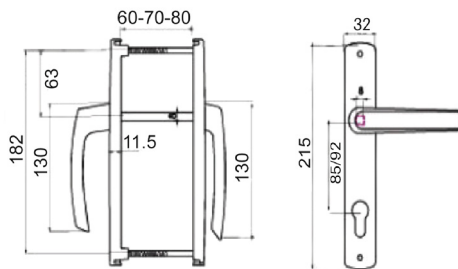

TIENDA



Manilla Danubio escudo/plana

Eje cuadradillo de 7mm

RAL			INTEREJE	REF.
9016	2	40	85x32	P2347-9016
9005	2	40	85x32	P2347-9005
CROMO	2	40	85x32	P2347-CROMO
9016	2	40	92X32	P2329-9016
8019	2	40	92X32	P2329-8019
8022	2	40	92X32	P2329-8022
9005	2	40	92X32	P2329-9005

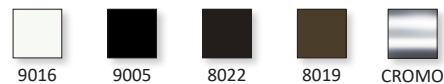

Häusen®

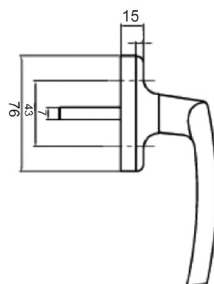

TIENDA



Manilla desplazada Tiber

Eje cuadradillo de 7mm

RAL			MANO	REF.
9016	2	40	Derecha	P2336D-9016
8022	2	40	Derecha	P2336D-8022
9005	2	40	Derecha	P2336D-9005
9016	2	40	Izquierda	P2336I-9016
8022	2	40	Izquierda	P2336I-8022
9005	2	40	Izquierda	P2336I-9005



Häusen®

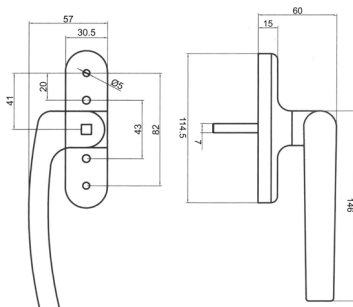

TIENDA



Manilla desplazada Tiber RF

Eje cuadradillo de 7mm

RAL			MANO	REF.
9016	4	40	Derecha	P2341D-9016
8022	4	40	Derecha	P2341D-8022
9005	4	40	Derecha	P2341D-9005
9016	4	40	Izquierda	P2341I-9016
8022	4	40	Izquierda	P2341I-8022
9005	4	40	Izquierda	P2341I-9005



Häusen®

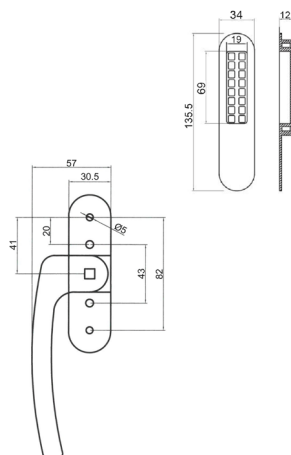

TIENDA



Manilla desplazada Tiber RF + uñero

Eje cuadradillo de 7mm



RAL			MANO	REF.
9016	4	40	Derecha	P2342D-9016
8022	4	40	Derecha	P2342D-8022
9005	4	40	Derecha	P2342D-9005
9016	4	40	Izquierda	P2342I-9016
8022	4	40	Izquierda	P2342I-8022
9005	4	40	Izquierda	P2342I-9005



Manilla desplazada Támesis

Eje cuadradillo de 7mm

Häusen®

RAL			MANO	REF.
9016	2	50	Derecha	J2310D-9016
9005	2	50	Derecha	J2310D-9005
9016	2	50	Izquierda	J2310I-9016
9005	2	50	Izquierda	J2310I-9005



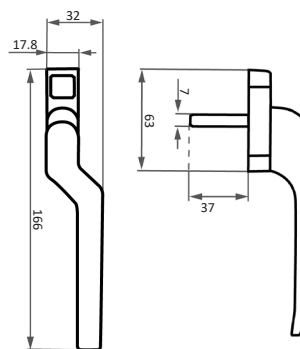

TIENDA



Cierre presión Murano

Häusen®

RAL				MANO	REF.
9016	2	25	30,3	Derecha	J1011D-9016
8019	2	25	30,3	Derecha	J1011D-8019
9016	2	25	30,3	Izquierda	J1011I-9016
8019	2	25	30,3	Izquierda	J1011I-8019



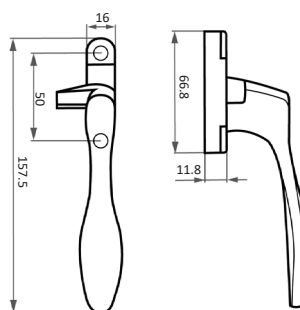

TIENDA



Cierre presión Venecia

Häusen®

RAL			MANO	REF.
9016	4	12	Derecha	H3500D-9016
9005	4	12	Derecha	H3500D-9005
9016	4	12	Izquierda	H3500I-9016
9005	4	12	Izquierda	H3500I-9005





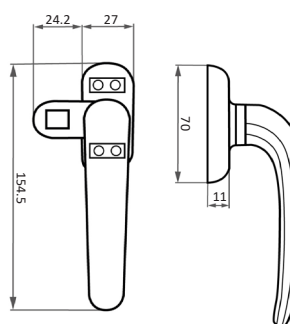

TIENDA



Manilla oculta Plane

Eje cuadradillo de 7mm, profundidad 8mm y 14mm

Häusen®

RAL						REF.
9016	2	8mm	50	10,00	390x290x210	J1027-9016
8022	2	8mm	50	10,00	390x290x210	J1027-8022
9005	2	8mm	50	10,00	390x290x210	J1027-9005
9006	2	8mm	50	10,00	390x290x210	J1027-9006
9016	2	14mm	50	10,00	390x290x210	P2321-9016
8022	2	14mm	50	10,00	390x290x210	P2321-8022
9005	2	14mm	50	10,00	390x290x210	P2321-9005

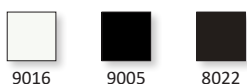

TIENDA

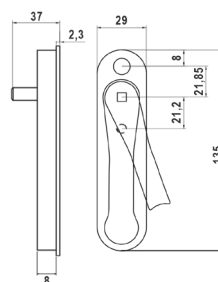

Häusen®

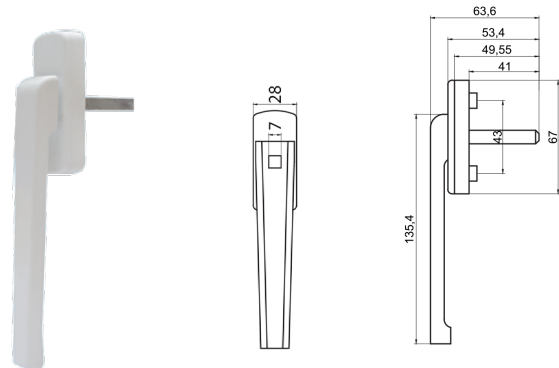

TIENDA



Manilla plana Low

Eje cuadradillo de 7mm

RAL				REF.
9016	2	50	16,00	P2318-9016
8019	2	50	16,00	P2318-8019
8022	2	50	16,00	P2318-8022
9005	2	50	16,00	P2318-9005



Häusen®

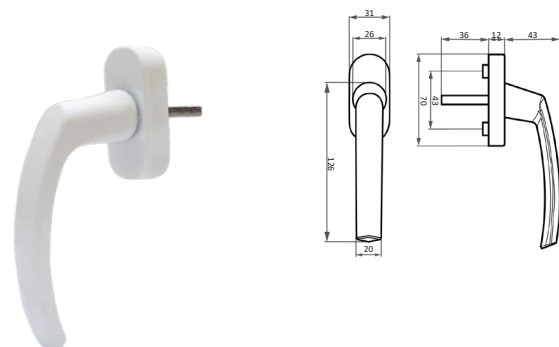

TIENDA



Manilla de PVC Sena

Eje cuadradillo de 7mm

RAL				REF.
9016	4	40	-	P2301-9016
8022	4	40	-	P2301-8022
9005	4	40	-	P2301-9005



Häusen®

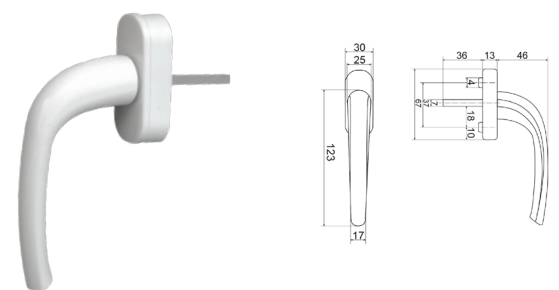

TIENDA



Manilla de aluminio Ebro

Eje cuadradillo de 7mm

RAL				REF.
9016	2	100	15,30	P2303-9016
8019	2	100	15,30	P2303-8019
8022	2	100	15,30	P2303-8022
9005	2	100	15,30	P2303-9005
INOX	2	100	15,30	P2303-INOX



Häusen®

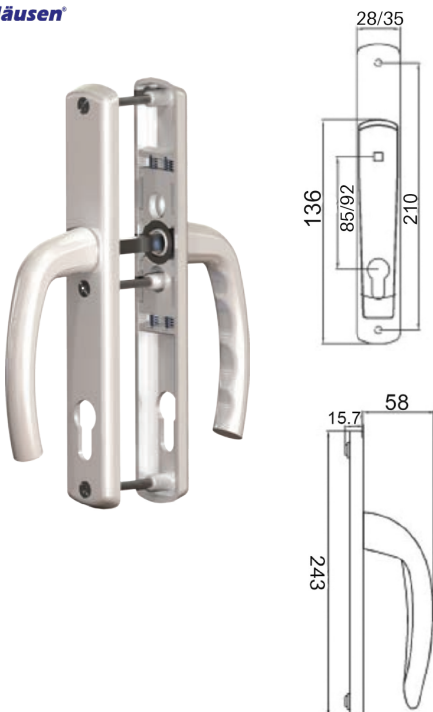

TIENDA



Juego manilla de escudo largo Báltico



Eje cuadradillo de 8mm

RAL				REF.
9016	2	40	19,00	P2312-9016
8019	2	40	19,00	P2312-8019
8022	2	40	19,00	P2312-8022
9005	2	40	19,00	P2312-9005
9006	2	40	19,00	P2312-9006
9016	2	40	19,00	P2317-9016
8019	2	40	19,00	P2317-8019
8022	2	40	19,00	P2317-8022
9005	2	40	19,00	P2317-9005
9016	2	40	19,00	P2309-9016
8019	2	40	19,00	P2309-8019
8022	2	40	19,00	P2309-8022
9006	2	40	19,00	P2309-9006
9005	2	40	19,00	P2309-9005
9016	2	40	19,00	P2308-9016
8019	2	40	19,00	P2308-8019
8022	2	40	19,00	P2308-8022
9005	2	40	19,00	P2308-9005
INOX	2	40	19,00	P2908-INOX

Juego manilla de escudo largo Báltico/muletilla

Eje cuadradillo de 8mm

Häusen®

RAL				REF.
9016	2	40	16,00	P2313-9016
8019	2	40	16,00	P2313-8019
8022	2	40	16,00	P2313-8022

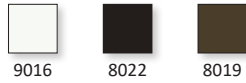

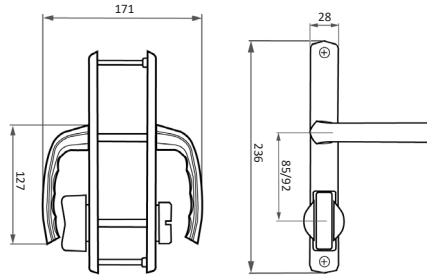

TIENDA



Juego manilla Mediterraneo + pomo

Eje cuadradillo de 8mm

Häusen®

RAL				INTEREJE	REF.
9016	2	40	19,00	85x32	P2368-9016
8019	2	40	19,00	85x32	P2368-8019
8022	2	40	19,00	85x32	P2368-8022
9016	2	40	19,00	92x32	P2330-9016
8019	2	40	19,00	92x32	P2330-8019
8022	2	40	19,00	92x32	P2330-8022



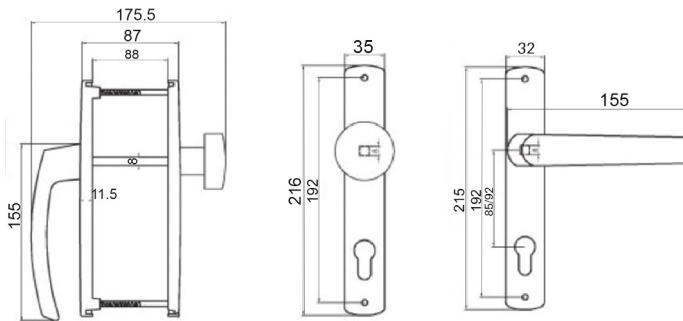

TIENDA



Juego manilla escudo largo Adriático

Häusen®

RAL				INTEREJE	REF.
9016	2	40	19,00	85x32	P2366-9016
8019	2	40	19,00	85x32	P2366-8019
8022	2	40	19,00	85x32	P2366-8022
9005	2	40	19,00	85x32	P2366-9005
9016	2	40	19,00	92x32	P2328-9016
8019	2	40	19,00	92x32	P2328-8019
8022	2	40	19,00	92x32	P2328-8022
9005	2	40	19,00	92x32	P2328-9005

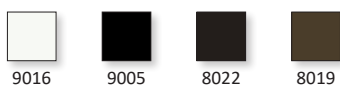

TIENDA

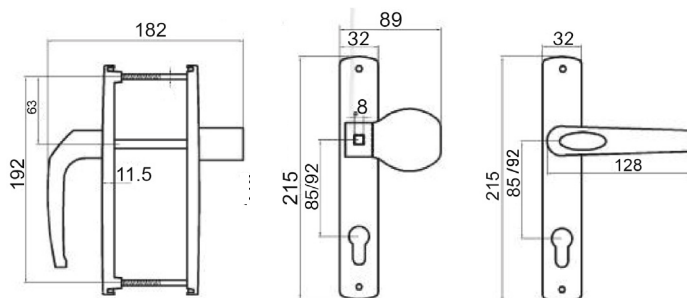

Häusen

Juego manilla escudo largo Caribe



TIENDA



RAL				INTEREJE	REF.
9016	2	40	19,00	85x32	P2367-9016
8022	2	40	19,00	85x32	P2367-8022
9016	2	40	19,00	85x32	P2332-9016
8022	2	40	19,00	92x32	P2332-8022

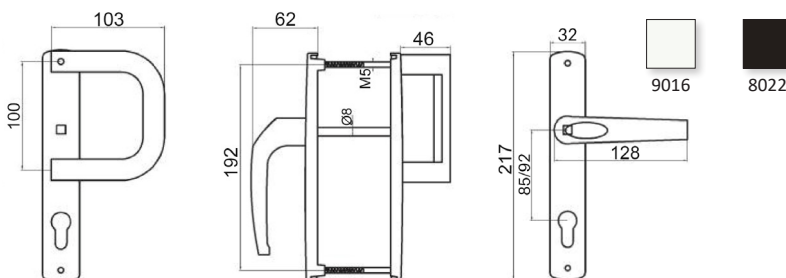

Manilla escudo largo Serpis (con y sin bocallave)



TIENDA



RAL				BOCALLAVE	INTEREJE	REF.
9016	2	---	---	Si	85mm	H6085-9016
9005	2	---	---	Si	85mm	H6085-9005
9016	2	---	---	Si	92mm	H6092-9016
9005	2	---	---	Si	92mm	H6092-9005
9016	2	---	---	No	---	H6090-9016
9005	2	---	---	No	---	H6090-9005



Escudo largo Serpis (con y sin bocallave)



TIENDA



RAL				BOCALLAVE	INTEREJE	REF.
9016	2	---	---	Si	85mm	H6185-9016
9005	2	---	---	Si	85mm	H6185-9005
9016	2	---	---	Si	92mm	H6192-9016
9005	2	---	---	Si	92mm	H6192-9005
9016	2	---	---	No	---	H6190-9016
9005	2	---	---	No	---	H6190-9005



Juego manilla Cronos con escudo



TIENDA

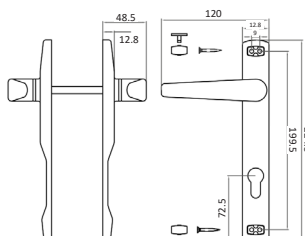

RAL.				REF.
9016	4	12	8,40	J1030-9016
9005	4	12	8,40	J1030-9005



fapim

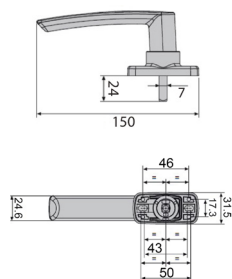

TIENDA



Eos - Manilla

	RAL			REF.
20	9016	2	4,50	92275
20	9005	2	4,50	94611
20	9006	2	4,50	85223
20	INOX	2	4,50	94732



fapim

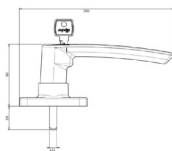

TIENDA



Eos - Manilla c/llave

	RAL			REF.
20	9016	2	4,50	30579
20	9005	2	4,50	94748
20	9006	2	4,50	30580

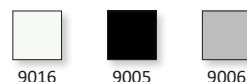

fapim



CUERPO GEA

TIENDA

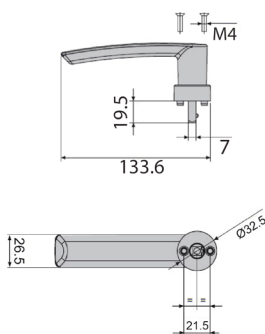

Iris - Manilla sin base

	RAL			REF.
10	9016	2	2,00	92924
10	9005	2	2,00	94608
10	9006	2	2,00	85224
10	INOX	2	2,00	92870



fapim

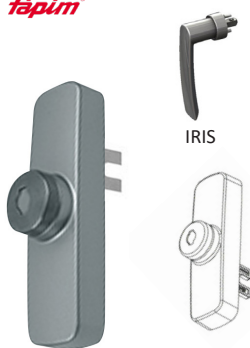

IRIS

TIENDA

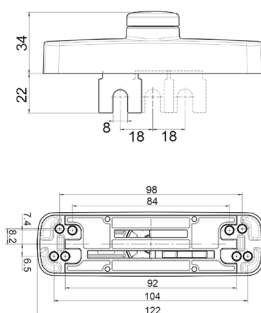

Gea - Base de 1 pala

	RAL			REF.
10	9016	2	3,20	85225
10	9005	2	3,20	85226
10	9006	2	3,20	85228
10	INOX	2	3,20	85227



fapim



IRIS

TIENDA

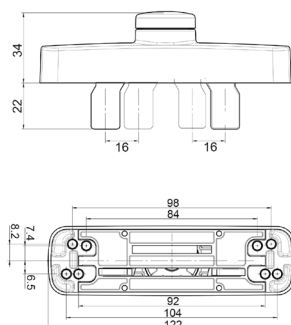



Gea - Base de 2 palas

	RAL			REF.
10	9016	2	3,40	85229
10	9005	2	3,40	85230
10	9006	2	3,40	85232
10	INOX	2	3,40	85231



Gea - Cremona de 2 palas

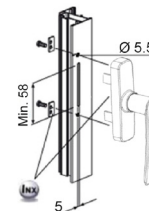
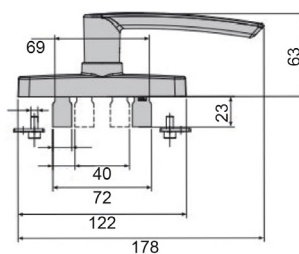
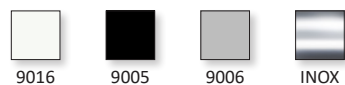

	RAL			REF.
50	9016	2	15,40	94570
50	9005	2	15,40	94650
50	9006	2	15,40	92272
50	INOX	2	15,40	94740



fapim



Gea - Cremona de 2 palas c/llave

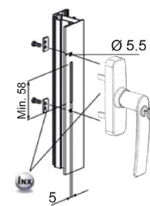
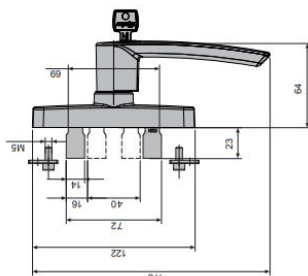

	RAL			REF.
10	9016	2	4,50	85271
10	9005	2	4,50	92976
10	9006	2	4,50	85272
10	ESPECIAL	2	4,50	85273



fapim



Gea - Cremona de 1 pala

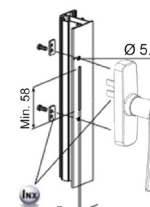
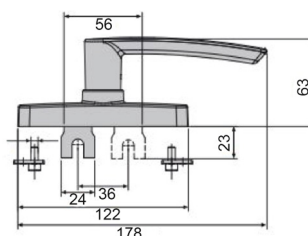
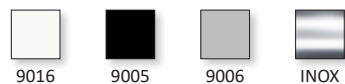

	RAL			REF.
10	9016	2	3,00	94571
10	9005	2	3,00	94573
10	9006	2	3,00	94574
10	INOX	2	3,00	94572



fapim



Gea - Cremona de 1 pala c/llave

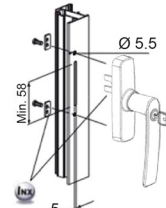
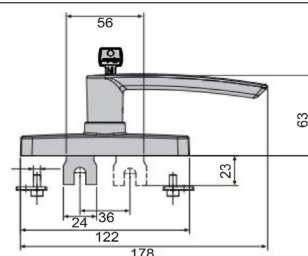
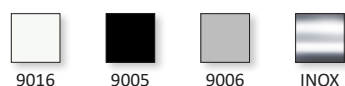

	RAL			REF.
10	9016	2	4,50	94747
10	9005	2	4,50	92911
10	9006	2	4,50	30524
10	INOX	2	4,50	86028



fapim



Hera - Juego manilla recuperable

	RAL			REF.
10	9016	2	5,70	94580
10	9005	2	5,70	94706
10	9006	2	5,70	94754
10	INOX	2	5,70	94708

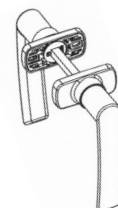
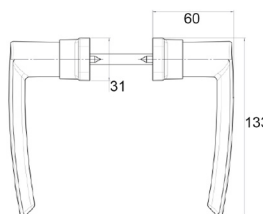
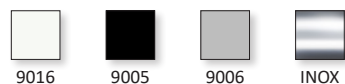

fapim



fapim

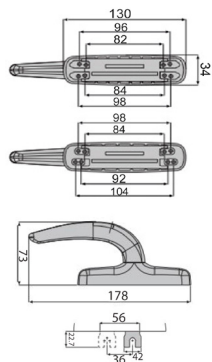
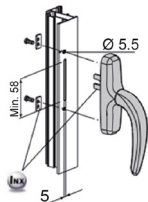

Nefer Midi - Cremona de 1 pala

	RAL			REF.
50	9016	2	14,40	95217
50	9005	2	14,40	95216
50	9006	2	14,40	95747
50	INOX	2	14,40	95951

TIENDA



fapim

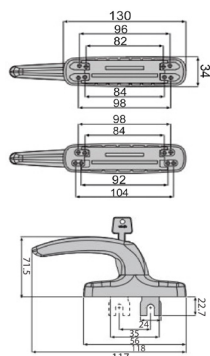
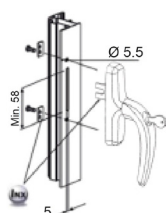

Nefer Midi - Cremona de 1 pala c/llave

	RAL			REF.
10	9016	2	3,40	88770
10	9005	2	3,40	88349
10	9006	2	3,40	99355
10	INOX	2	3,40	95796
10	ORO	2	3,40	98494

TIENDA



fapim

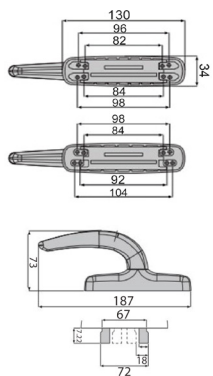
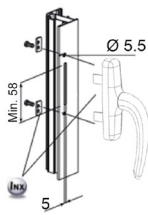

Nefer Midi - Cremona de 2 palas

	RAL			REF.
10	9016	2	14,00	95218
10	9005	2	14,00	95219
10	9006	2	14,50	94503
10	INOX	2	14,00	92564

TIENDA



fapim

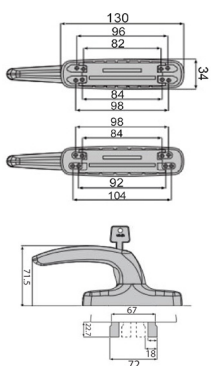
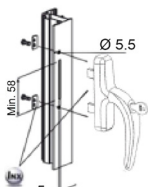

Nefer Midi - Cremona de 2 palas c/llave

	RAL			REF.
10	9016	2	3,70	99021
10	9005	2	3,70	98251
10	9006	2	3,70	99303
10	INOX	2	3,70	98455

TIENDA



fapim

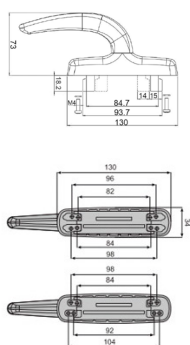
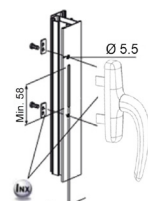



Ramses - Cremona apertura exterior de 2 palas

	RAL			REF.
10	9016	2	6,00	88064
10	9006	2	6,00	98110
10	INOX	2	6,00	98673

TIENDA



Ramses - Cremona apertura exterior de 2 palas c/llave

	RAL			REF.
10	9016	2	6,00	92335
10	9005	2	6,00	98335
10	9006	2	6,00	85279

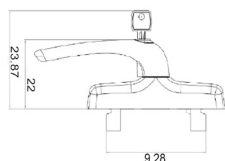
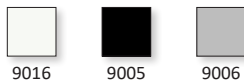

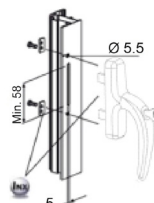
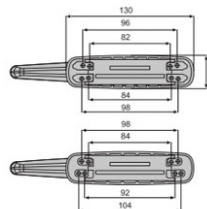

TIENDA



fapim

Osiride - Manilla

	RAL			REF.
50	9016	2	14,00	88855
50	9005	2	14,00	88800
50	9006	2	14,00	88960
50	INOX	2	14,00	99228



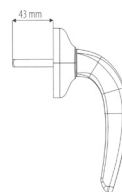
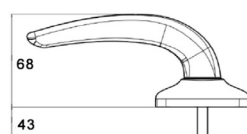

TIENDA

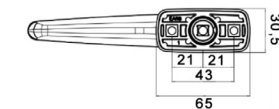

fapim



Osiride - Manilla c/llave

	RAL			REF.
10	9016	2	3,60	98123
10	9005	2	3,60	88799
10	9006	2	3,60	88796
10	INOX	2	3,60	94281

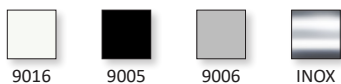

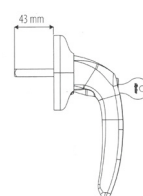
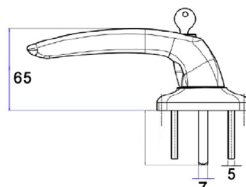

TIENDA

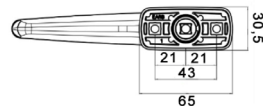

fapim



Horus - Juego manilla

	RAL			REF.
10	9016	2	5,60	88906
10	9005	2	5,60	88167
10	9006	2	5,60	88923
10	INOX	2	5,60	99229
10	ORO	2	5,60	88257

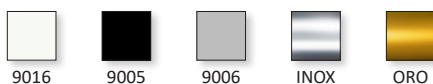

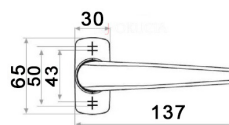
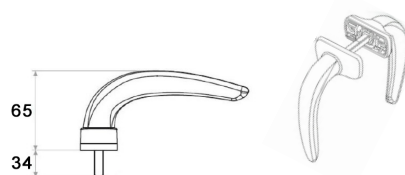

TIENDA



fapim

Horus - Manilla fina

	RAL			REF.
20	9016	2	-	88907
20	9005	2	-	88707
20	9006	2	-	99340
20	INOX	2	-	95907
20	ORO	2	-	98037

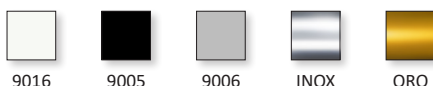

TIENDA

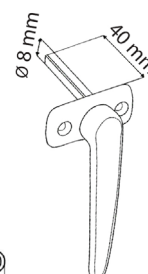
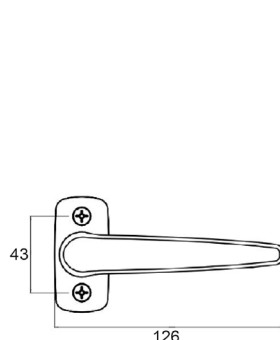

fapim

fapim

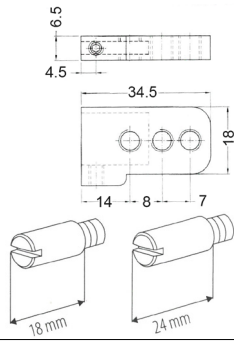

Prolongador de pala de cremona ap. exterior

TIENDA



	RAL		Kg	REF.
20	-	-	0,20	J1200
20	-	-	0,20	J1201
100	-	-	0,50	98172

fapim

78040

78881

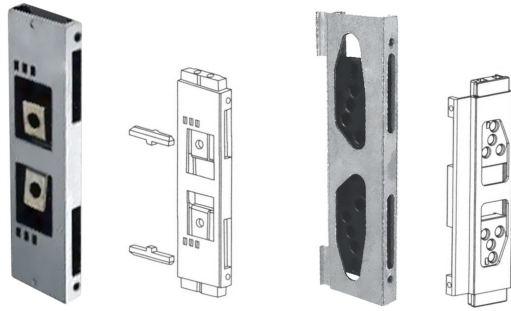

TIENDA



Mecanismo de apertura exterior

DESCRIPCIÓN		Kg	REF.
Kit fijación 40x20	50	1,00	78040
Kit fijación C.E.	50	1,00	78881

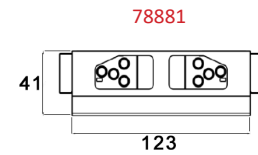
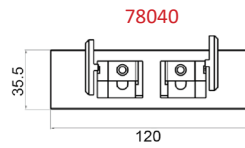

fapim

TIENDA



Cubrecilindro seguridad forma de pera

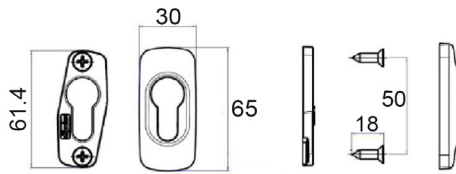
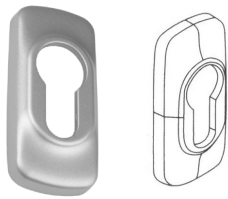

	RAL		Kg	REF.
20	9016	2	1,40	88808
20	9005	2	1,40	88165
20	9006	2	1,40	99481
20	INOX	2	1,40	95906

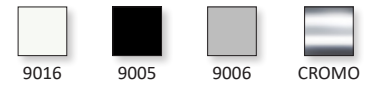

Häusen®

Bocallave ovalado

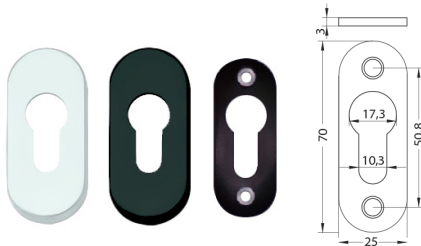

TIENDA



RAL			Kg		REF.
9016	2	100	2,25	290x250x160	H7100-9016
9005	2	100	2,25	290x250x160	H7100-9005



Häusen®

Bocallave Colibrí



9016 9005 8019

TIENDA





RAL			Kg		REF.
9016	2	100	3,85	70x116x37	P4201-9016
9005	2	100	3,85	70x116x37	P4201-9005
8019	2	100	3,85	70x116x37	P4201-8019
8022	2	100	3,85	70x116x37	P4201-8022
ORO	2	100	3,85	70x116x37	P4201-ORO
CROMO	2	100	3,85	70x116x37	P4201-CROMO

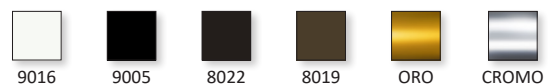

8022 ORO CROMO



Uñero tirador PVC

RAL			REF.
9016	2	100	P2305-9016
8022	2	100	P2305-8022
9005	2	100	P2305-9005
8019	2	100	P2305-8019
9006	2	100	P2305-9006



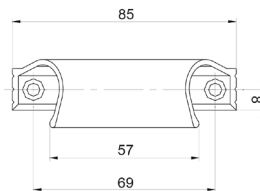

TIENDA



Häusen®



Tirador Roa



	RAL		REF.
10	9016	2	78782
10	9005	2	78547
10	8019	2	99797



TIENDA



Tirador Lerma



	RAL		REF.
20	9016	2	98257
20	9005	2	96306
20	9006	2	99768



TIENDA



Asa aluminio

	RAL		REF.
100	9016	2	P2307-9016
100	8022	2	P2307-8022
100	8019	2	P2307-8019



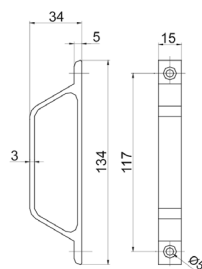

TIENDA



Häusen®



Asa recta

	RAL		REF.
12	9016	2	98518
12	9005	2	98519



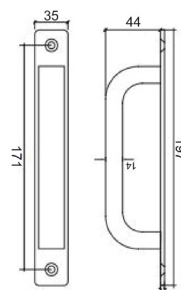

TIENDA



Häusen®



Asa desplazada

	RAL		REF.
12	9016	2	99062
12	9005	2	99608



TIENDA

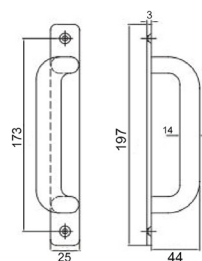

Häusen®



TIENDA



Apolo - Tubo tirador inox Ø40mm.

	RAL	Ø		REF.
10	9016	40mm	2.000mm	99126
10	9005	40mm	2.500mm	99127



Apolo - Soporte final inf/sup.

	RAL	Ø	REF.
10	9016	40 / 50	95031
10	9005	40 / 50	92126



Ø50mm

Ø40mm

TIENDA



Apolo - Soporte intermedio



	RAL	REF.
12	9016	94769
12	9005	92984
12	INOX	92688

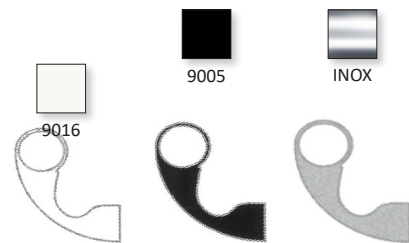

TIENDA



Apolo - Tapón embellecedor



	RAL	Ø	REF.
8	9016	40	94770
8	9005	40	92985
8	INOX	40	94268

TIENDA



Apolo - Tuerca



	RAL	REF.
1	9016	85263
1	9005	85264
1	INOX	94269

TIENDA



Tirador simple

	RAL	REF.
1	INOX	98823

TIENDA

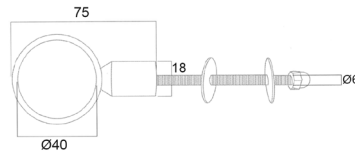

Tirador simple pasante

	RAL	REF.
1	INOX	92983

TIENDA

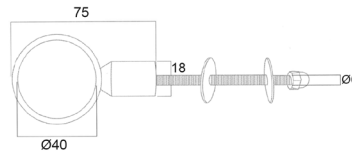

Tirador simple desplazado

	RAL	REF.
1	INOX	92615

TIENDA

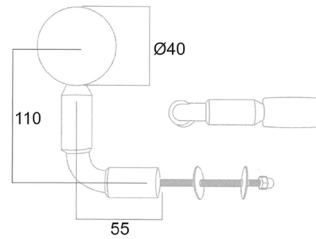

Tirador doble

	RAL	REF.
1	INOX	98824

TIENDA

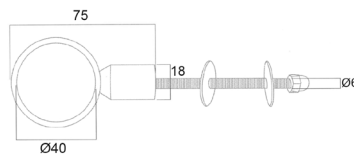

Tirador doble pasante

	RAL	REF.
1	INOX	95924

TIENDA

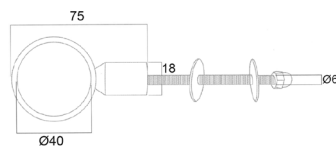

Tirador doble desplazado

	RAL	REF.
1	INOX	92982

TIENDA

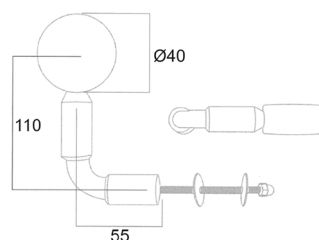

Tirador Taurus



9016



9005



9006



INOX

DESCRIPCIÓN		RAL	REF.
Tirador Taurus simple	1	9016	96254
Tirador Taurus simple	1	9005	96255
Tirador Taurus simple	1	9006	96256
Tirador Taurus simple	1	INOX	94127
Tirador Taurus doble	1	9016	92270
Tirador Taurus doble	1	9005	92271
Tirador Taurus doble	1	9006	94775
Tirador Taurus doble	1	INOX	92979

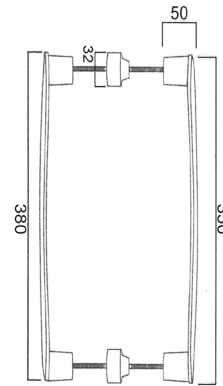

TIENDA



Tirador Austral



9016



9005



NIQUEL

MANO		RAL	REF.
Izquierda	1	9016	98703
Izquierda	1	9005	98807
Izquierda	1	NIQUEL	98806
Derecha	1	9016	98681
Derecha	1	9005	98940
Derecha	1	NIQUEL	99081
Doble	1 Juego	9016	98324
Doble	1 Juego	9005	98325
Doble	1 Juego	NIQUEL	98326

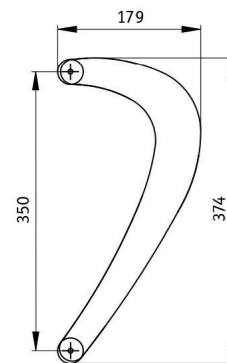

TIENDA



PARA MAS INFORMACIÓN DESCARGUE
EL CATÁLOGO ESPECIAL DE:

TIRADORES INOX

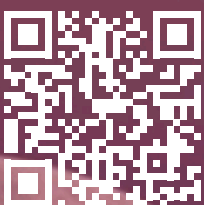



Väalar



Vostok



Eyre



Cenot



Vänern



Leman



Yulia



Krystal



Baikal



Kremen

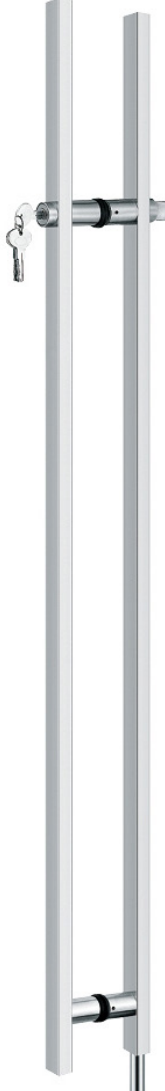

Reindeer



Caspio



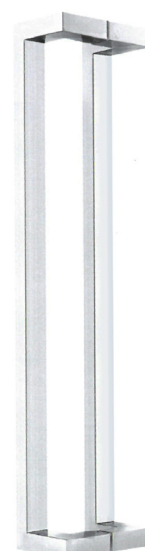

Ládoga



Onega





Rejilla panel sándwich

			REF.
800 x 200 x 10	1	1	79016
800 x 200 x 18	1	1	88801

TIENDA





Rejilla metálica cuadrada

COLOR			REF.
Blanco	15 x 15	1	23049
Blanco	20 x 20	1	46146

TIENDA





Rejilla metálica doble

COLOR	CARAS			REF.
Blanco	1	800 x 200	1	78104
Blanco	2	800 x 200	1	78113

TIENDA





Rejilla deslizante

			RAL	€	REF.
1	275mm	22mm	9010	38,18 €	H5100-9010
1	275mm	22mm	9005	38,18 €	H5100-9005
1	375mm	22mm	9010	43,26 €	H5101-9010
1	375mm	22mm	9005	43,26 €	H5101-9005
1	475mm	22mm	9010	47,81 €	H5102-9010
1	475mm	22mm	9005	47,81 €	H5102-9005
1	700mm	22mm	9010	58,53 €	H5103-9010
1	700mm	22mm	9005	58,53 €	H5103-9005

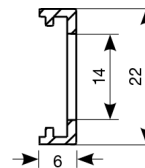
TIENDA



Rejilla basculante

			RAL	€	REF.
1	275mm	23mm	9010	37,47 €	H5111-9010
1	275mm	23mm	9005	37,47 €	H5111-9005
1	375mm	23mm	9010	42,59 €	H5112-9010
1	375mm	23mm	9005	42,59 €	H5112-9005
1	475mm	23mm	9010	47,49 €	H5113-9010
1	475mm	23mm	9005	47,49 €	H5113-9005
1	700mm	23mm	9010	58,34 €	H5114-9010
1	700mm	23mm	9005	58,34 €	H5114-9005

TIENDA

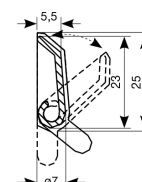
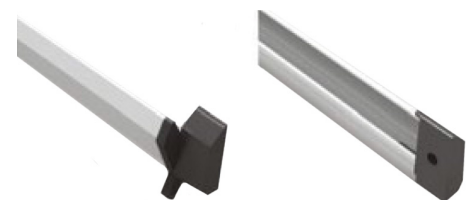



Apertura telescópica



Apertura por husillo

CON ZÓCALO – Luz Hueco obra = Luz zócalo

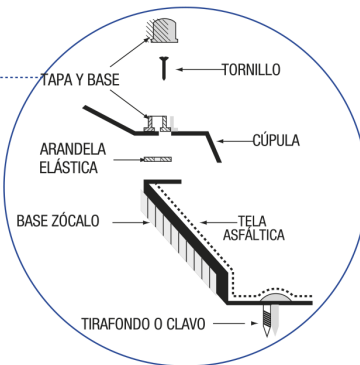
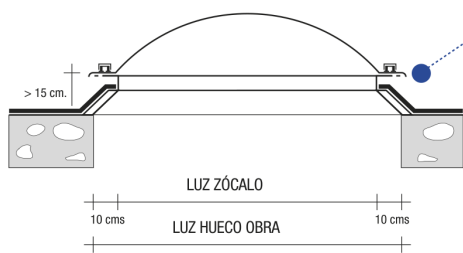

Esquema de Montaje de cúpula sobre base-zócalo.

MONTAJE DEL ZÓCALO

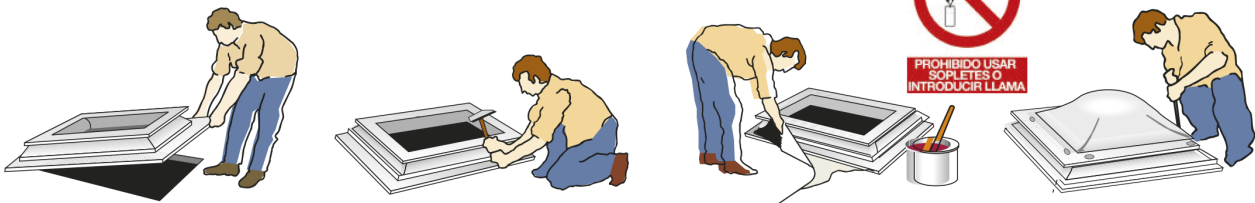

Claraboyas cuadradas

MEDIDA	FIJA	TELESCÓPICA	POR HUSILLO
40 x 40	Consultar	-	Consultar
50 x 50	Consultar	-	Consultar
60 x 60	Consultar	Consultar	Consultar
70 x 70	Consultar	Consultar	Consultar
80 x 80	Consultar	Consultar	Consultar
90 x 90	Consultar	Consultar	Consultar
100 x 100	Consultar	Consultar	Consultar
120 x 120	Consultar	Consultar	Consultar
140 x 140	Consultar	Consultar	Consultar
150 x 150	Consultar	Consultar	Consultar
160 x 160	Consultar		Consultar
180 x 180	Consultar	-	Consultar
200 x 200	Consultar	-	Consultar

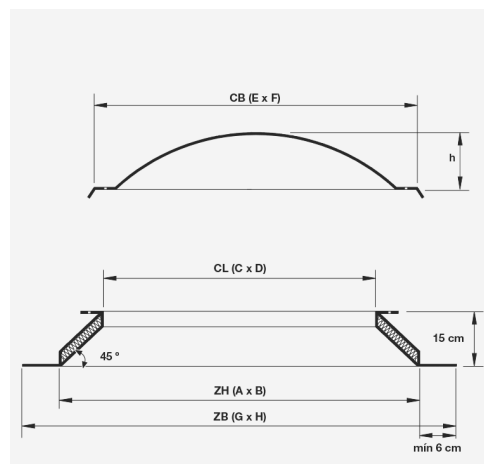
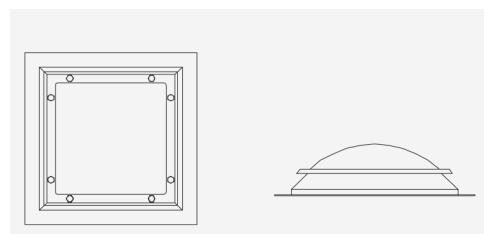

Claraboyas rectangulares

MEDIDA	FIJA	TELESCÓPICA	POR HUSILLO
50 X 100	Consultar	Consultar	Consultar
60 X 90	Consultar	Consultar	Consultar
60 X 100	Consultar	Consultar	Consultar
60 X 120	Consultar	Consultar	Consultar
70 X 100	Consultar	Consultar	Consultar
80 X 100	Consultar	Consultar	Consultar
80 X 120	Consultar	Consultar	Consultar
90 X 120	Consultar	Consultar	Consultar
100 X 150	Consultar	Consultar	Consultar
100 X 200	Consultar	Consultar	Consultar
150 X 200	Consultar	-	Consultar
160 X 240	Consultar	-	Consultar
200 X 300	Consultar	-	Consultar

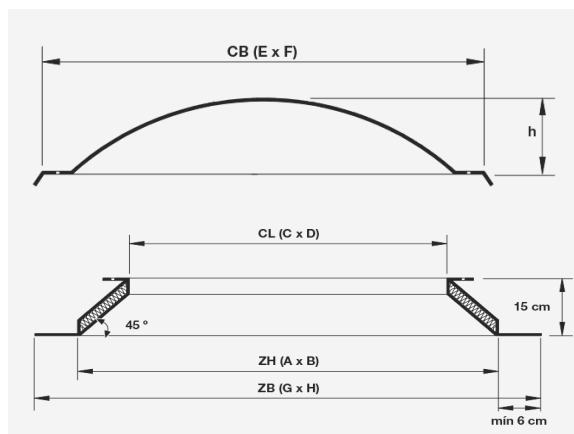
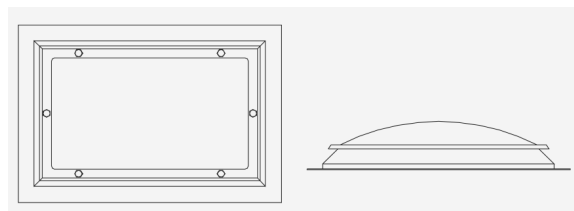

Apertura pivotante/proyectante

5/7	5/9	6/11	7/9	7/11	7/14	9/9	9/11	11/11	11/14	13/9	13/14
54 X 78	54 X 98	65 X 118	74 X 98	74 X 118	74 X 140	94 X 98	94 X 118	114 X 118	114 X 140	134 X 98	134 X 140
Consultar	Consultar	Consultar	Consultar	Consultar	Consultar	Consultar	Consultar	Consultar	Consultar	Consultar	Consultar



Tapajuntas estándar

5/7	5/9	6/11	7/9	7/11	7/14	9/9	9/11	11/11	11/14	13/9	13/14
54 X 78	54 X 98	65 X 118	74 X 98	74 X 118	74 X 140	94 X 98	94 X 118	114 X 118	114 X 140	134 X 98	134 X 140
Consultar	Consultar	Consultar	Consultar	Consultar	Consultar	Consultar	Consultar	Consultar	Consultar	Consultar	Consultar



Cortinilla de oscuridad total

5/7	5/9	6/11	7/9	7/11	7/14	9/9	9/11	11/11	11/14	13/9	13/14
54 X 78	54 X 98	65 X 118	74 X 98	74 X 118	74 X 140	94 X 98	94 X 118	114 X 118	114 X 140	134 X 98	134 X 140
Consultar	Consultar	Consultar	Consultar	Consultar	Consultar	Consultar	Consultar	Consultar	Consultar	Consultar	Consultar

Diseños disponibles:



Cortinilla de oscuridad total

Línea decorativa

5/7	5/9	6/11	7/9	7/11	7/14	9/9	9/11	11/11	11/14	13/9	13/14
54 X 78	54 X 98	65 X 118	74 X 98	74 X 118	74 X 140	94 X 98	94 X 118	114 X 118	114 X 140	134 X 98	134 X 140
Consultar	Consultar	Consultar	Consultar	Consultar	Consultar	Consultar	Consultar	Consultar	Consultar	Consultar	Consultar

Diseños disponibles:

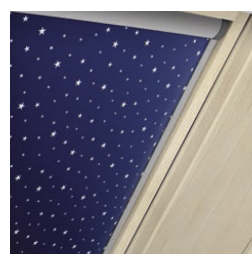

Persianas de ventanas de techo

5/7	5/9	6/11	7/9	7/11	7/14	9/9	9/11	11/11	11/14	13/9	13/14
54 X 78	54 X 98	65 X 118	74 X 98	74 X 118	74 X 140	94 X 98	94 X 118	114 X 118	114 X 140	134 X 98	134 X 140
Consultar	Consultar	Consultar	Consultar	Consultar	Consultar	Consultar	Consultar	Consultar	Consultar	Consultar	Consultar



Escalera escamoteable de madera de 3 tramos

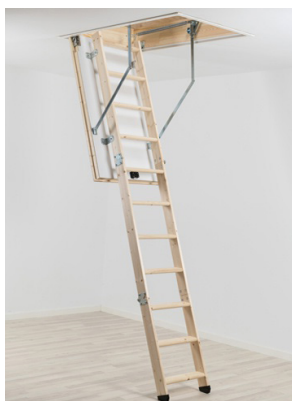

MEDIDA HUECO	MEDIDA EXTERIOR	ALTURA DE SUELO A TECHO
112 X 60	110 X 58	262 CM
120 X 50	118 X 48	285 CM
120 X 60	118 X 58	285 CM
120 X 70	118 X 68	285 CM

VARILLA PASAMOS EN UN LATERAL (COLOR ROJO)

Escalera escamoteable de madera de 2 tramos



MEDIDA HUECO	MEDIDA EXTERIOR	ALTURA DE SUELO A TECHO
120 X 60	118 X 58	220 - 235 CM
140 X 70	138 X 68	220 - 235 CM

VARILLA PASAMOS EN UN LATERAL

Escalera escamoteable metálica lacada de 3 tramos



MEDIDA HUECO	MEDIDA EXTERIOR	ALTURA DE SUELO A TECHO
120 X 60	119 X 59	220 - 280 CM
140 X 70	119 X 69	220 - 280 CM

Escalera escamoteable galvanizada de 4 tramos



MEDIDA HUECO	MEDIDA EXTERIOR	ALTURA DE SUELO A TECHO
100 X 70	99 X 69	271 - 300 CM
130 X 70	129 X 69	271 - 350 CM

OL90N - Sistema de apertura a distancia

	DESCRIPCIÓN		RAL	REF.
1	Compás OL90N	-	9016	93182
1	Compás OL90N	-	9005	93255
1	Compás OL90N	-	9006	93121
1	Guarnición OL90N	-	9016	93183
1	Guarnición OL90N	-	9005	93254
1	Guarnición OL90N	-	9006	93120
1	Varilla zincada 300mm OL90N	300mm	9006	93122
1	Perfil 3.000mm OL90N	3.000mm	9016	93123
1	Perfil 3.000mm OL90N	3.000mm	9005	93256
1	Perfil 3.000mm OL90N	3.000mm	9006	93284
1	Grapa mando OL90N	-	9006	93124

TIENDA



Compass - Mecanismo manual de apertura a distancia

TIENDA



	RAL	REF.
1	9016	98450
1	9005	98047



Fijación simple y rápida utilizando tornillos autoroscantes que permiten su aplicación también sobre cerramientos ya montados o en sustitución de viejos golpetes

Base de dimensión reducida para aplicarlo más cómodamente

Sistema de bloqueo metálico para garantizar un cierre muy resistente

Solución específica de la cuerda de maniobra para utilizarla sobre todas las abatibles. Incluso en condiciones de espacios reducidos, sin necesidad de otros accesorios complementarios.

Dimensiones reducidas para mejorar la estética.

Cuerda de maniobra muy robusta que garantiza una larga duración.

Botón de enganche/desenganche para una maniobra segura y cómoda.

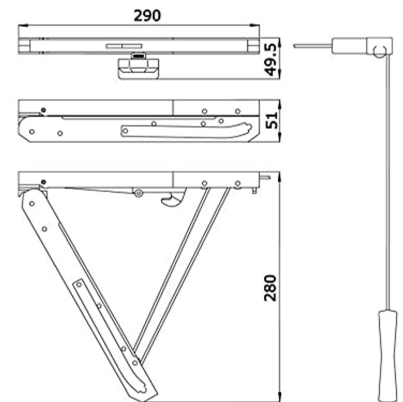

Apertura de 220mm para mejorar la ventilación.

Amplia ranura de regulación que permite aplicarlo tanto sobre los perfiles enrasados, como sobre los perfiles con resalte.

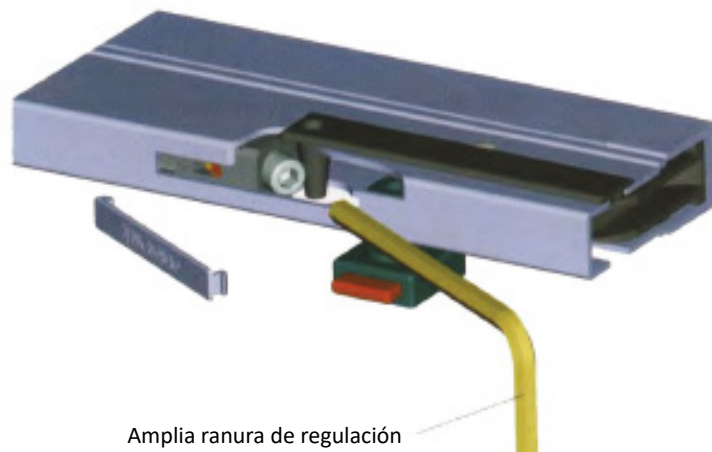

Amplia ranura de regulación que permite aplicarlo tanto sobre los perfiles enrasados, como sobre los perfiles con resalte.

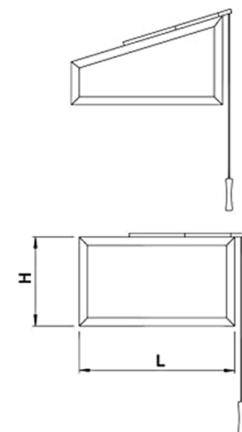

L	H
400 - 1500	350 - 1600
Max 80 Kg	

Motor de apertura de cadena

	RAL	REF.
1	9016	H9000-9016
1	9005	H9000-9005
1	9006	H9000-9006

TIENDA

Características

- Posicionado mediante microprocesador
- Fuerza de empuje y tracción de 300 N
- Alimentado con 230v AC ó 24v DC
- Longitud de carrera de fácil ajuste entre 110, 200, 300, 400 mm.
- Final de carrera electrónico tanto en la entrada como en la salida de la cadena
- Opción de conexionado en paralelo de varios motores sin controlador adicional
- Montaje y desmontaje sencillo del motor sin tornillos

Versión estándar

El motor se suministra incluidos los accesorios precisos para apertura exterior, interior, pivotante y lucernarios. Colores estándar:

Campo de aplicación

- Apto para apertura interior y exterior
- Ventanas pivotantes
- Lucernarios

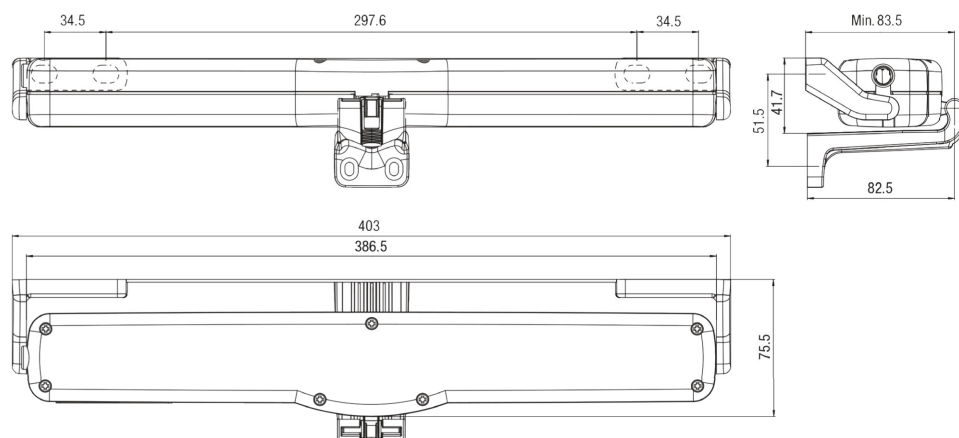

BlickDomi

My SmartWindow

NOVEDOSO Y ECONÓMICO SISTEMA DE CONTROL PARA PERSIANAS Y MOTORES DE CADENA

BlickDomi es un complemento de la ventana y queda perfectamente integrado en esta. Su pulsador táctil capacitivo se instala sobre el marco del cerramiento a la altura deseada por el cliente para facilitar su uso.

El dispositivo se conecta a la red eléctrica y se enlaza con la red Wi-Fi de la vivienda de forma rápida y sencilla.

Al tener el pulsador integrado en el marco se elimina el costoso pulsador integrado en la pared, evitando además el tener que realizar las molestas obras necesarias para su instalación.

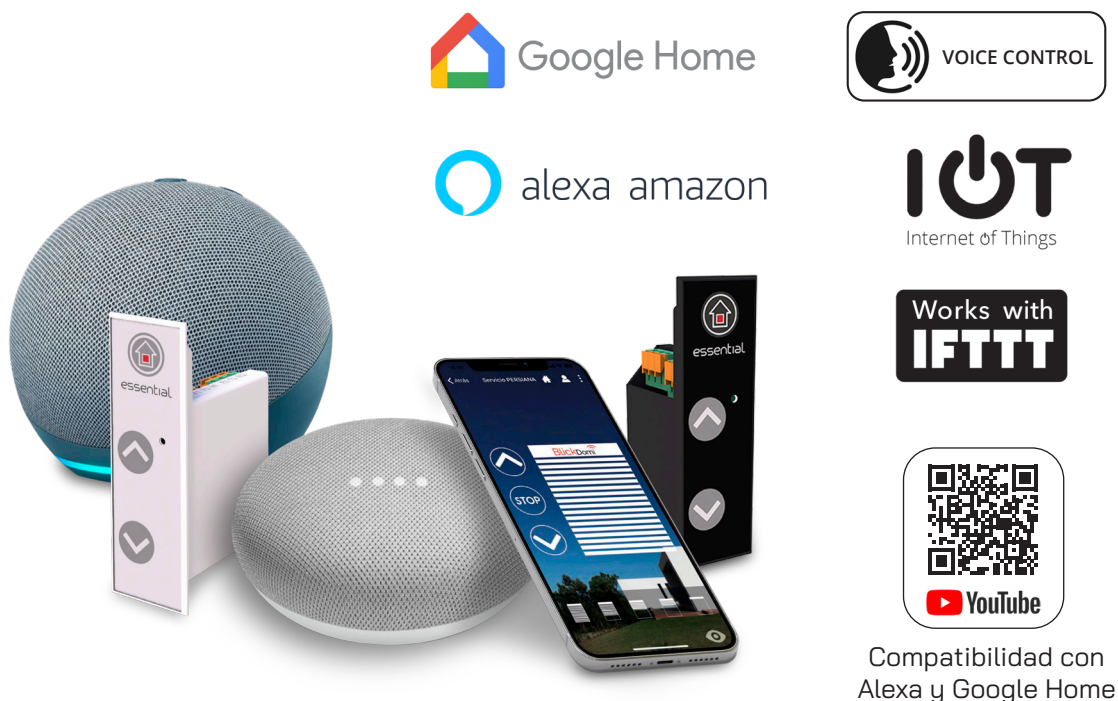

Compatibilidad con Alexa y Google Home

BlickDomi es un dispositivo muy fácil de instalar.

Recomendable para:

- Ventanas de PVC y Aluminio.
- Sistemas correderas, oscilo-batientes y practicables.
- Tipologías de ventanas, balconeras y puertas.

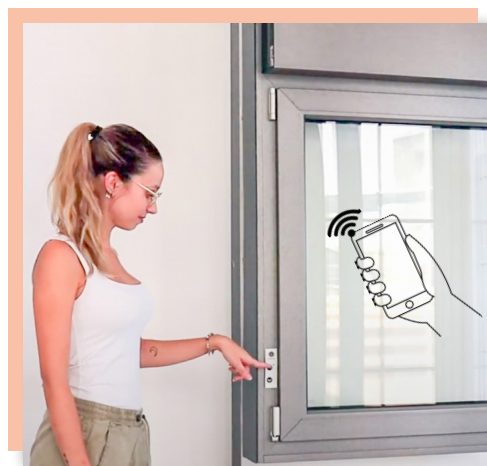

CONNECT-1 es la **evolución** del accionamiento de persiana.

Integra un pulsador capacitivo en el marco de la ventana que nos permite el **uso tradicional** del sistema, además dispone de una APP para su control mediante el **smartphone** tanto en el interior de la vivienda como desde cualquier lugar, gracias a su conexión **Wifi**.

CONNECT-1 comunica **directamente** al usuario con sus persianas, sin necesidad de ningún dispositivo puente extra.



Control de los accionamientos

- Subida y bajada de persianas.
- Detección de obstáculos
- Twin digital de la persiana en tiempo real.

Conexión y tecnología

- Conexión remota vía la Wi-fi del hogar.
- Tecnología IoT y recetas IFTTT para facilitar la interacción con otros sistemas.
- Provisto de actualizaciones vía OTA.



Interacción

- Pulsador capacitivo encastrado en marco.
- APP para IOS y Android.
- Compatible con Alexa y Google Home.

TIENDA



Blickdomi smart windows Connect 1

COLOR				REF.
BLANCO	-	1	0,70	H9027
NEGRO	-	1	0,70	H9026

CONNECT-2 nos permite **accionar** los automatismos de la ventana, así como **conocer** el entorno que rodea a esta

Sus sensores ambientales nos facilitan **decidir** sobre las necesidades de apertura y renovación de aire en la estancia y la capacidad para detectar posibles intrusiones, nos brinda una **tranquilidad** extra en nuestro hogar.

Todo esto sin la necesidad de dispositivos externos al cerramiento, evitando costes innecesarios y molestos aparatos.

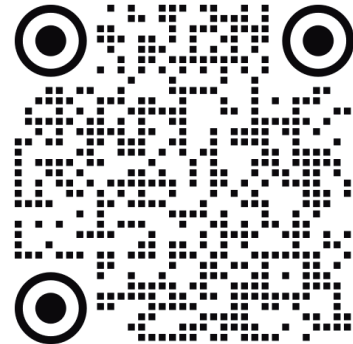

Control de los accionamientos

- Subida y bajada de persianas.
- Apertura de hoja.

Conexión y tecnología

- Conexión remota vía la Wi-fi del hogar.
- Tecnología IoT y recetas IFTTT para facilitar la interacción con otros sistemas.

Seguridad

- Sensor de forzado y apertura.
- Alarma de intento de intrusión.

Salud y Confort

- Sensor de temperatura, humedad, CO₂ y gases VOC.
- Alarma de calidad del aire.

Interacción



- Pulsador capacitivo encastrado en marco.
- APP para IOS y Android.



TIENDA



Blickdomi smart windows Connect 2

COLOR				REF.
BLANCO	-	1	0,75	H9029
NEGRO	-	1	0,75	H9028

Pulsador conmutador de pared para empotrar (con cable)

	CANALES	REF.
1	1	H9003

TIENDA



Pulsador de pared inalámbrico de 1 canal

	CANALES	REF.
1	1	H9004

TIENDA



Pulsador de pared inalámbrico con temporizador hasta 5 canales

	CANALES	REF.
1	5	H9005

TIENDA



Mando emisor de 1 canal

	CANALES	REF.
1	1	H9006

TIENDA



Mando emisor de hasta 15 canales

	CANALES	REF.
1	15	H9007

TIENDA



Mini mando emisor de bolsillo de 1 canal

	CANALES	REF.
1	1	H9008

TIENDA



Receptor inalámbrico con entrada para pulsador

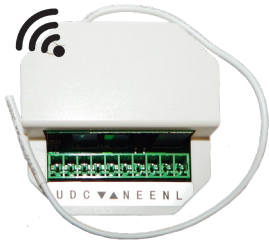

	REF.
1	H9001

Módulo teleruptor para 2 motores

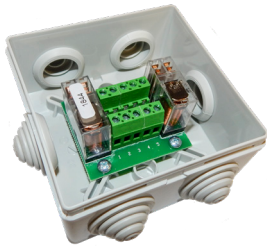

	REF.
1	H9002

Mapa de 1 ventana sin sistema inalámbrico

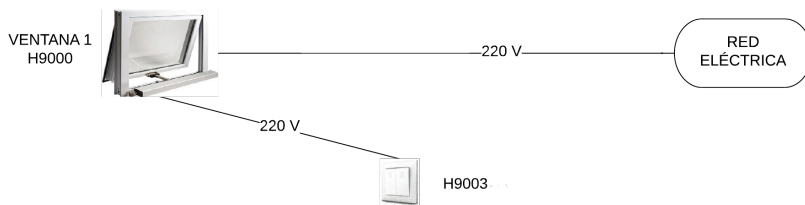

OPCIONES DE EMISORES:

* OPCION 1: H9003 (1 CANAL, POR CABLE) "1 UNIDAD"

Mapa de 1 ventana en 1 canal

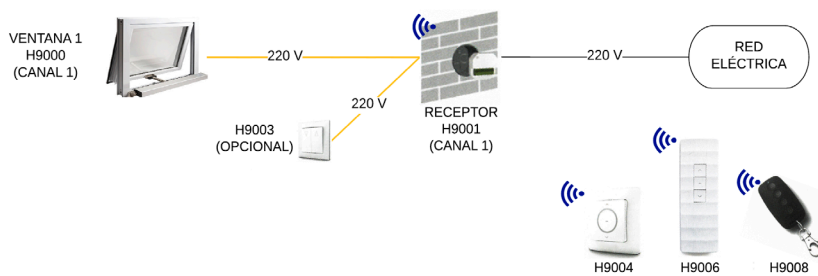

EL RECEPTOR SOLO PUEDE ALIMENTAR A 1 MOTOR.

AÑADIENDO UN TELERUPTOR AUMENTARÍAMOS LA CAPACIDAD HASTA UN MÁXIMO DE 2 MOTORES.

OPCIONES DE EMISORES:

* OPCION 1: H9003 (1 CANAL, POR CABLE) "1 UNIDAD"

* OPCION 2: H9004 (1 CANAL, INALAMBRICO) "1 UNIDAD"

* OPCION 3: H9006 (1 CANAL, INALAMBRICO) "1 UNIDAD"

* OPCION 4: H9008 (1 CANAL, INALAMBRICO) "1 UNIDAD"

Mapa de 2 ventanas en 1 canal

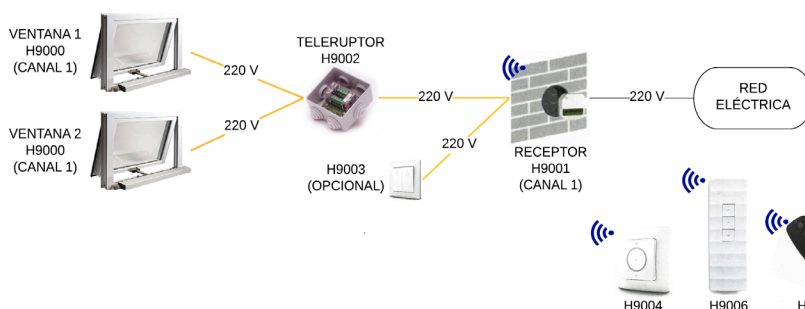

EL RECEPTOR SOLO PUEDE ALIMENTAR A 1 MOTOR.

AÑADIENDO EL TELERUPTOR HEMOS AUMENTADO LA CAPACIDAD HASTA UN MÁXIMO DE 2 MOTORES.

OPCIONES DE EMISORES:

* OPCION 1: H9003 (1 CANAL, POR CABLE) "1 UNIDAD"

* OPCION 2: H9004 (1 CANAL, INALAMBRICO) "1 UNIDAD"

* OPCION 3: H9006 (1 CANAL, INALAMBRICO) "1 UNIDAD"

* OPCION 4: H9008 (1 CANAL, INALAMBRICO) "1 UNIDAD"

Mapa de 6 ventanas en 3 canales

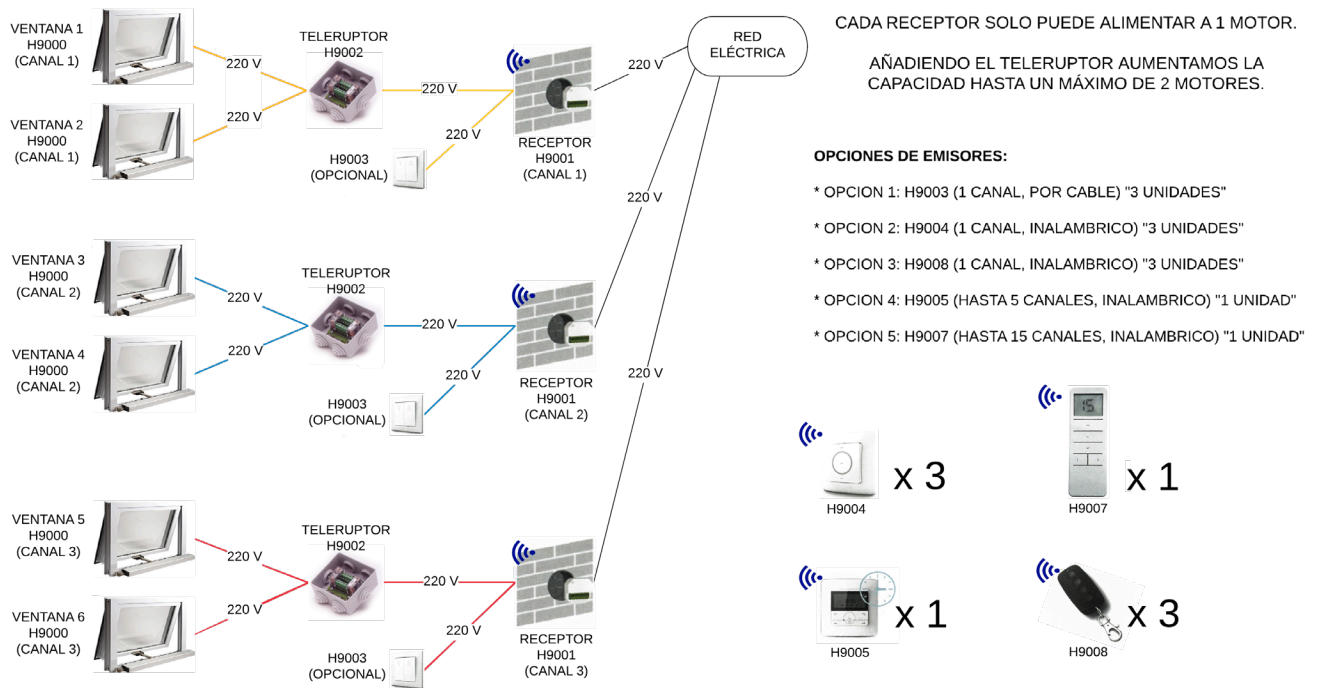

Mapa mixto

Inalámbrico y por cable con distintos canales

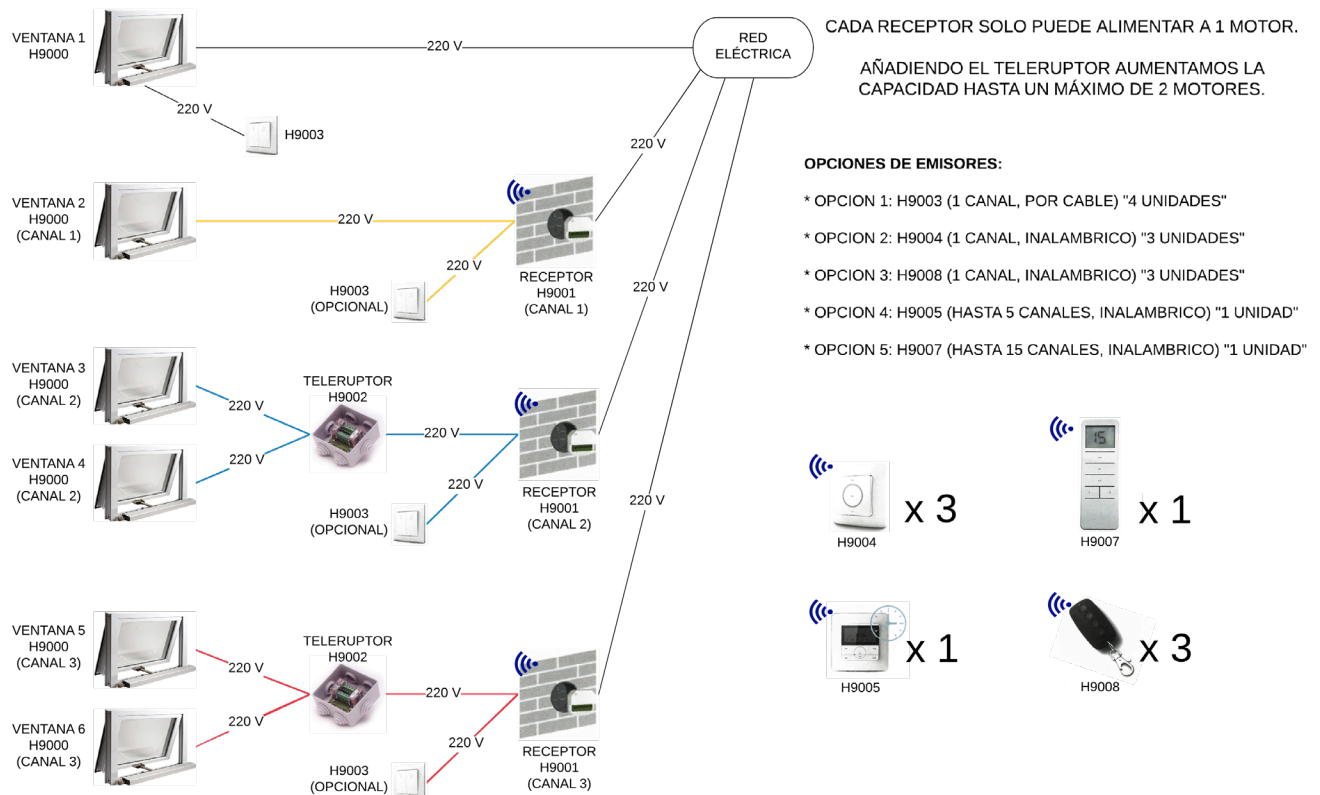

Puertas blindadas

- 1 Marco de acero:**
De 100 mm fabricado en chapa de acero galvanizado de 1,5 mm.
- 2 Hoja:**
Fabricada en chapa de acero de 1 mm, inyectada con espuma de poliuretano de alta densidad.
- 3 Cerradura:**
De 1, 3 o 5 puntos, con escudo de seguridad antitaladro y cilindro europeo con llaves de puntos y posibilidad de cerradura adicional para el servicio.
- 4 Bisagras:**
3 o 4 bisagras de seguridad antipalanca.
- 5 Junta de estanqueidad:**
Perimetral de caucho.
- 6 Manilla:**
Circular de acero inoxidable.
- 7 Pomo:**
En acero inoxidable.
- 8 Cortavientos (opcional):**
Escamoteable embutido en la parte inferior de la hoja.



Atenas



Bizancio



Pompeya



Tebas



Megara



Alejandria



Corinto



Cartago



Babilonia



Roma

Puertas blindadas minimalistas



- 1 Marco de acero:**
De 100 mm fabricado en chapa de acero galvanizado de 1,5 mm.
- 2 Hoja:**
Fabricada en chapa de acero de 1 mm, inyectada con espuma de poliuretano de alta densidad.
- 3 Cerradura:**
De 1, 3 o 5 puntos, con escudo de seguridad antitaladro y cilindro europeo con llaves de puntos y posibilidad de cerradura adicional para el servicio.
- 4 Bisagras:**
3 o 4 bisagras de seguridad antipalanca.
- 5 Junta de estanqueidad:**
Perimetral de caucho.
- 6 Manilla:**
Cuadrado de acero inoxidable.
- 7 Pomo:**
En acero inoxidable.
- 8 Cortavientos (opcional):**
Escamoteable embutido en la parte inferior de la hoja.



Éfeso



Siracusa



Tarraco



Hispania



Galia



Dalmacia



Antioquia



Corduba



Tracia



Lucentum

Laterales y dinteles

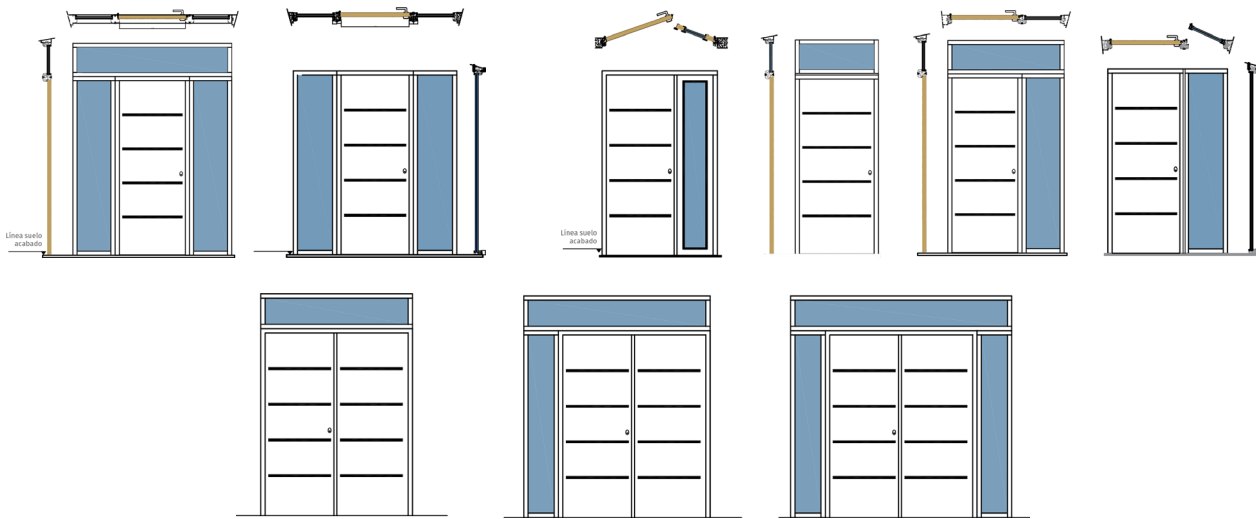

DIN-1



DIN-2



DIN-3



DIN-4

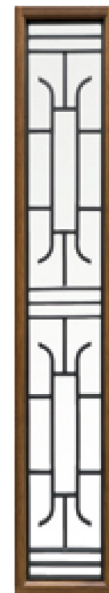

DIN-5



DIN-6



DIN-7



DIN-8



DIN-9



DIN-10

FUNCIÓN AUTOMÁTICA (A)

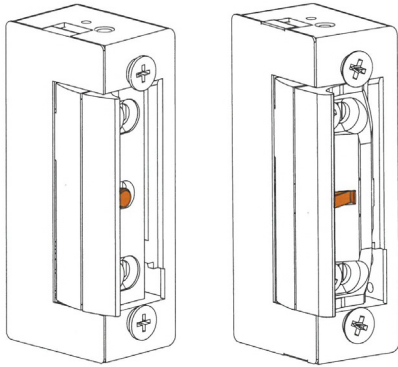

El funcionamiento automático permite que la puerta quede abierta hasta que se produce el acceso. Esta función la hace posible un bulón en el frontal del mecanismo que cuando recibe la electricidad activa la función automática.

DESBLOQUEO (D)

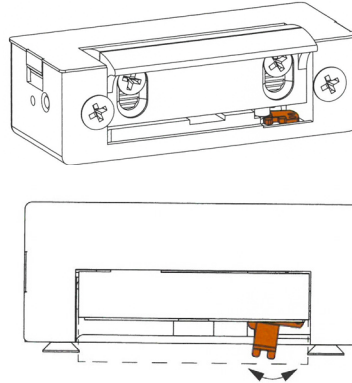

El sistema de palanca de desbloqueo permite dejar el abrepuertas desbloqueado permanentemente. Volviendo a activarla recupera su funcionamiento normal. Esta opción es ideal para portales donde se quiere dejar la puerta abierta durante periodos prolongados de tiempo.

FLEX (F)

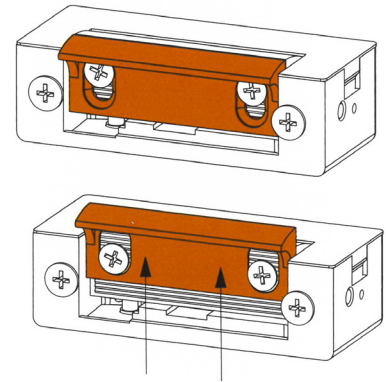

La versión con aleta Flex consiste en un pestillo que gracias a su posibilidad de desplazamiento permite ajustarse al picaporte de la cerradura.



PERFIL RECORTADO CLÁSICO



**PERFIL SIN RECORTAR
NUEVA SERIE MULTIVOLTAJE**

Abrepuertas eléctrico serie estrecha ADF 220V ac

TIENDA



- PESTILLO RADIAL
- SIMÉTRICO
- REVERSIBLE
- REDUCIDAS DIMENSIONES

	TAMAÑO	REF.
1	CORTO	99729
1	LARGO	99460

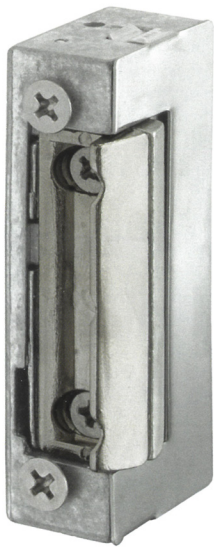
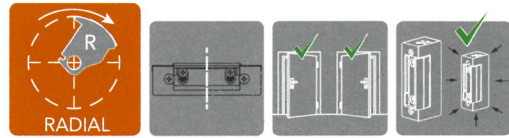

(A) AUTOMÁTICO
(D) DESBLOQUEO
(F) FLEX

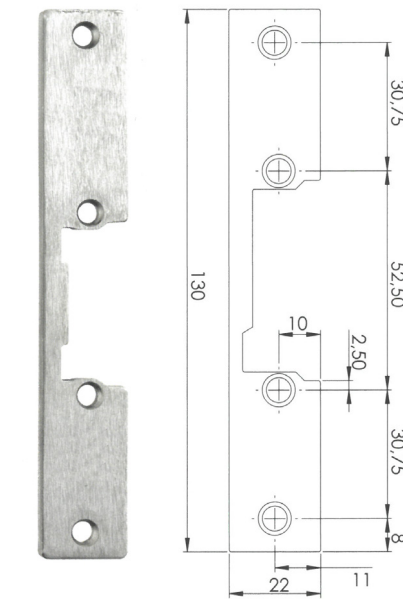

FRETE CORTO

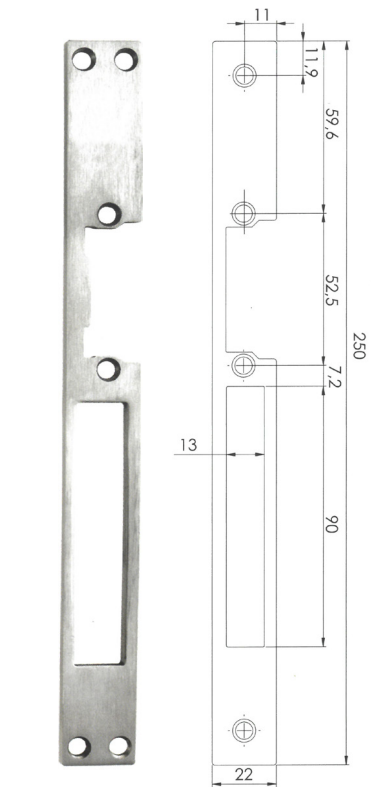

FRETE LARGO

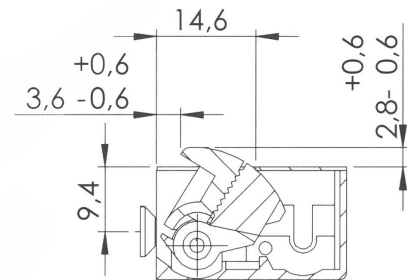
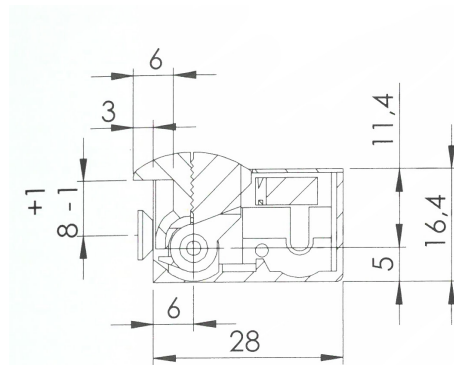
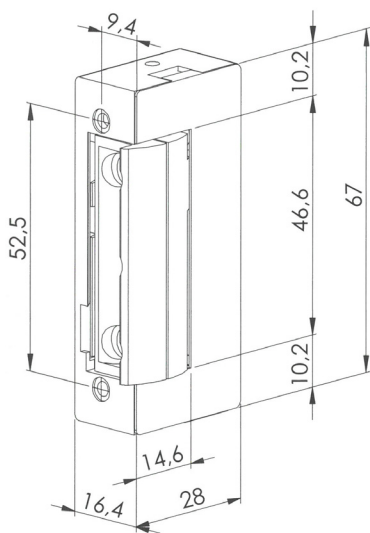

Abrepuertas eléctrico serie estrecha multivoltaje ADF 12-24V dc / 220V ac

Nueva serie estrecha multivoltaje sin corte de perfil

TAMAÑO	REF.
1 CORTO	92986
1 LARGO	94626

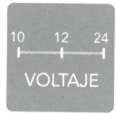

- NUEVO SISTEMA CON RAMPA DE GUIADO DEL PICAPORTE
- TAPA CON SISTEMA ANTIGRIPADO
- MULTIVOLTAJE
- FUNCIONAMIENTO EN AC Y DC
- REDUCIDAS DIMENSIONES
- PESTILLO RADIAL
- SIMÉTRICO
- REVERSIBLE
- CERTIFICACIÓN UNE EN 14846

TIENDA

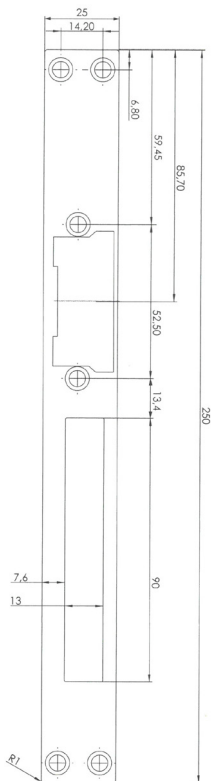

FRENTE LARGO

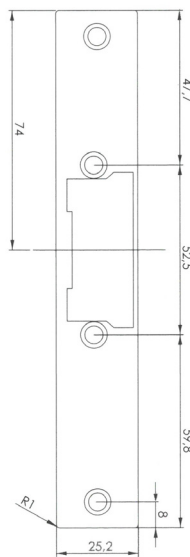

FRENTE CORTO

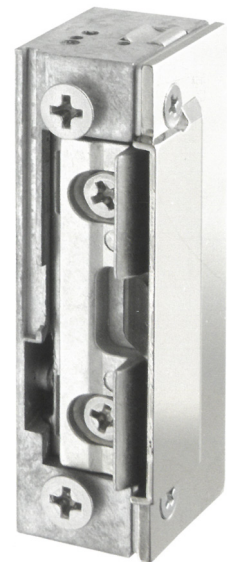

(A) AUTOMÁTICO
(D) DESBLOQUEO
(F) FLEX

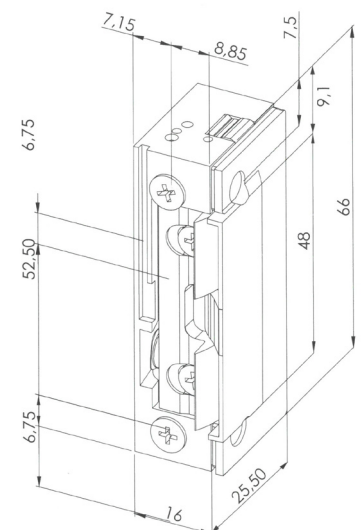
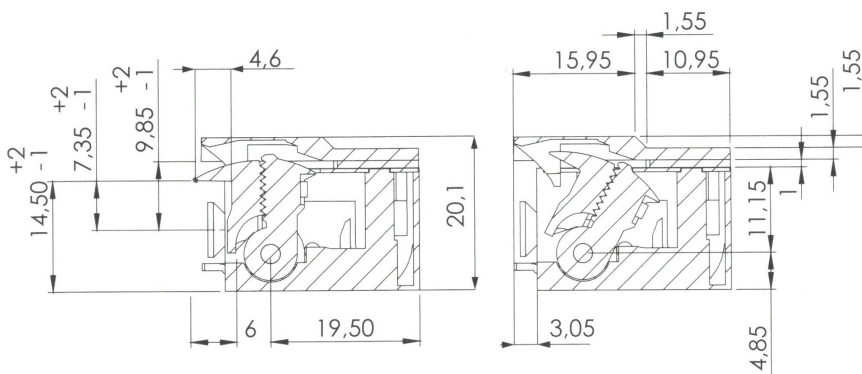

Kit abrepuertas eléctrico con mando a distancia



85
USUARIOS



	DESCRIPCIÓN	REF.
1	Kit mando + receptor 433MHz	92061
1	Mando a distancia 433Hz	92063

- ALCANCE HASTA 50 METROS EN ESPACIO ABIERTO
- APERTURA MEDIANTE MANDO A DISTANCIA
- 85 USUARIOS
- RECEPTOR INTEGRADO
- DOBLE CANAL PARA DOS PUERTAS

TIENDA



ESQUEMA DE MONTAJE

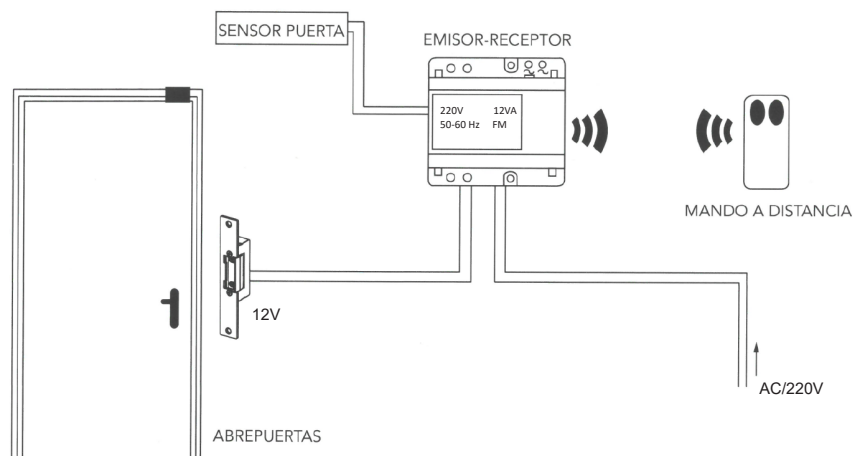
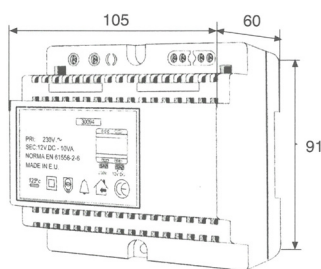

Pasacables metálico flexible para puertas

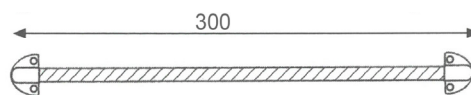

	REF.
1 300mm	85241

TIENDA



Juego contactos eléctricos 2 puntos para puertas

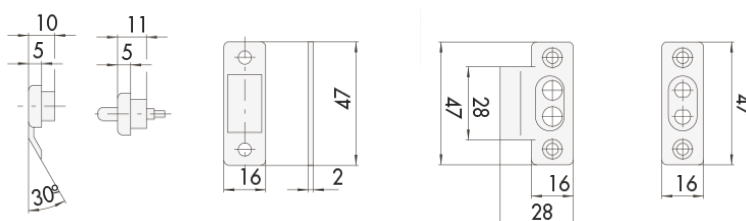

	REF.
10 Negro	95110

TIENDA



12RL - Cierrapuertas aéreo

	FUERZA		REF.
1	3 - 4	9016	25124
1	3 - 4	9005	25715
1	3 - 4	9006	25127

TIENDA

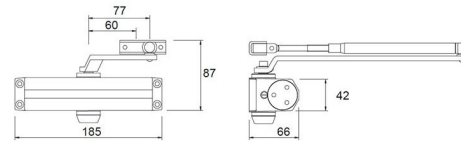

Justor

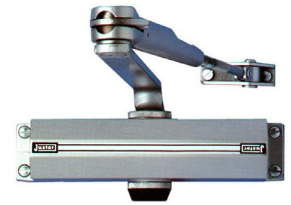

13PR - Cierrapuertas aéreo

	FUERZA		REF.
1	2 - 4	9016	25128
1	2 - 4	9005	25714
1	2 - 4	9006	25130

TIENDA

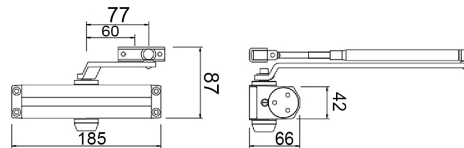

Justor

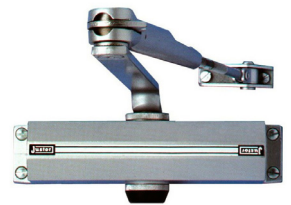

14PR - Cierrapuertas aéreo

	FUERZA		REF.
1	1 - 4	9016	87535
1	1 - 4	9005	80154
1	1 - 4	9006	80099

TIENDA

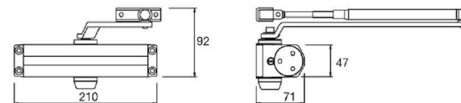

Justor

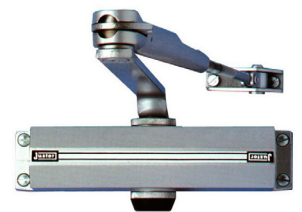

TS4000 - Cierrapuertas aéreo

	FUERZA		REF.
1	1 - 6	9016	K78206
1	1 - 6	9005	K78207

TIENDA

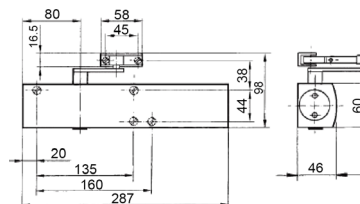

GEZE



TS5000 - Cierrapuertas aéreo

	FUERZA		REF.
1	3 - 5	9016	K78210
1	3 - 5	9005	K78211
1	3 - 5	9006	K78216

TIENDA

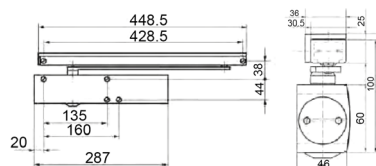

GEZE



TS93 - Cierrapuertas aéreo

	FUERZA		REF.
1	2 - 5	9006	K78299

TIENDA

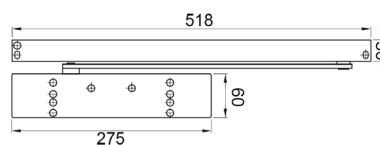

DORMA



GEZE

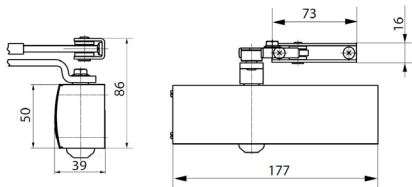

TS1500 - Cierrapuertas aéreo

TIENDA



	FUERZA		REF.
1	3 - 4	9016	K78200
1	3 - 4	9005	K78201
1	3 - 4	9006	K78212

GEZE

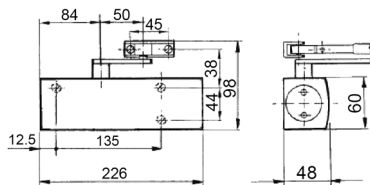

TS2000 - Cierrapuertas aéreo

TIENDA



	FUERZA		REF.
1	2 - 4	9016	K78204
1	2 - 4	9005	K78205
1	2 - 4	9006	K78214

GEZE

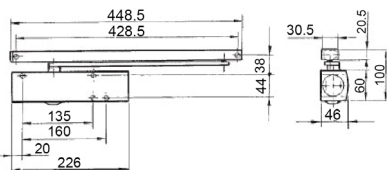

TS3000 - Cierrapuertas aéreo

TIENDA



	FUERZA		REF.
1	1 - 4	9016	K78208
1	1 - 4	9005	K78209
1	1 - 4	9006	K78215

GEZE

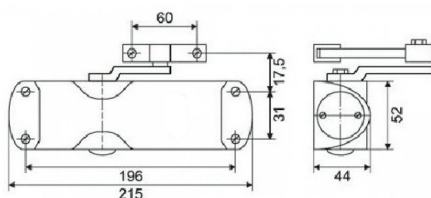

TS1000 - Cierrapuertas aéreo

TIENDA



	FUERZA		REF.
1	2 - 3	9016	90812
1	2 - 3	9005	90811
1	2 - 3	9006	90810

GEZE

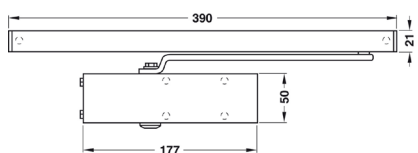

TS1500 - Cierrapuertas aéreo

TIENDA



	FUERZA		REF.
1	1 - 3	9016	K78202
1	1 - 3	9005	K78203
1	1 - 3	9006	K78213

DORMA

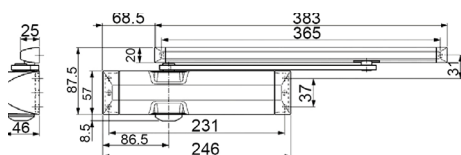

TS90 - Cierrapuertas aéreo

TIENDA



	FUERZA		REF.
1	3 - 4	9016	92529
1	3 - 4	9005	92528
1	3 - 4	9006	92530

TS71 - Cierrapuertas aéreo

	FUERZA		REF.
1	2 - 4	9016	92594
1	2 - 4	9005	92595
1	2 - 4	9006	92596

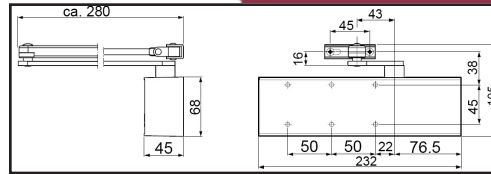

TIENDA



TS68 - Cierrapuertas aéreo

	RETENCIÓN	FUERZA		REF.
1	No	2 - 4	9016	96160
1	No	2 - 4	9005	96159
1	No	2 - 4	9006	94774
1	Si	2 - 4	9016	92525
1	Si	2 - 4	9005	92526
1	Si	2 - 4	9006	92527

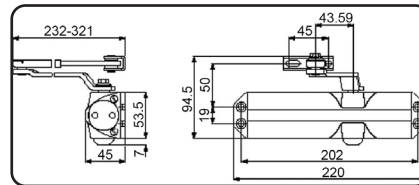

TIENDA



Boxer - Cierrapuertas oculto

	FUERZA		REF.
1	3 - 4	-	90831

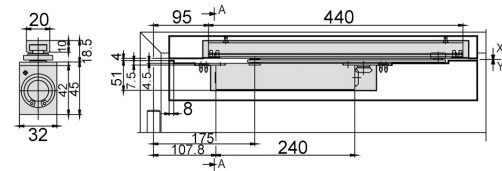

TIENDA



Boxer - Guía vaivén

	REF.
1	90834

TIENDA



TS550 - Cierrapuertas de suelo

	FUERZA		REF.
1	3 - 6	-	95910

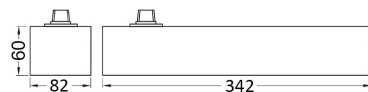

TIENDA



TS500 - Cierrapuertas de suelo

	RETENCIÓN	FUERZA	REF.
1	No	1 - 4	90954
1	Si	1 - 4	90955

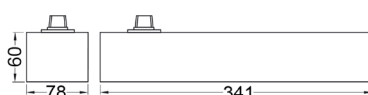

TIENDA



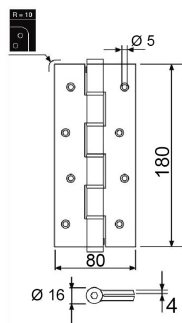

Bisagra de muelle

TIENDA



		REF.
2	9016	80819
2	9005	87128

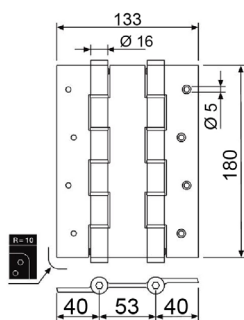

Bisagra vaivén de doble acción

TIENDA



		REF.
2	9016	87171
2	9005	87172
2	ORO	92855
2	BRONCE	87024

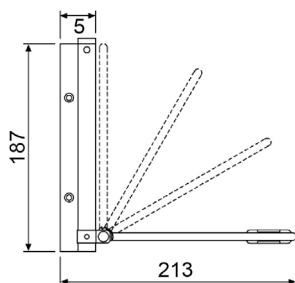

Muelle de brazo

TIENDA



		REF.
1	9016	90233
1	9005	94000
1	ORO	93386
1	CROMO	94001

Freno retenedor de puerta

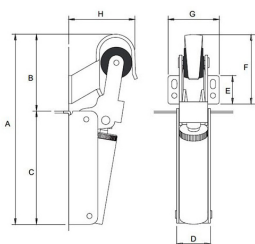

TIENDA



		REF.
1	9016	87302
1	9005	80928
1	9006	25747
1	BRONCE	80919
1	ORO	87301

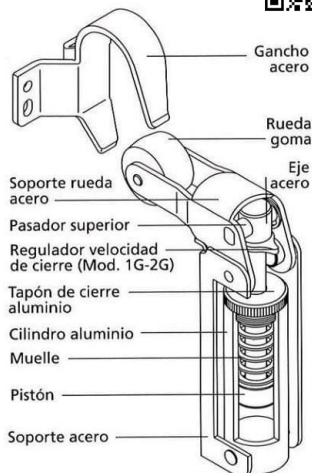
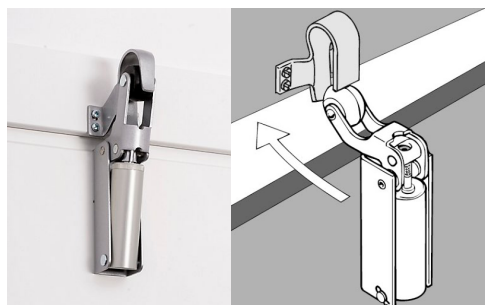

Bajopuertas fijo sobrepuesto

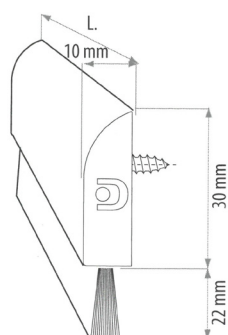

			REF.
10	1.000mm	Blanco	99078
10	1.000mm	Negro	99079
10	1.000mm	Plata	92713



TIENDA



Bajopuertas fijo sobrepuesto



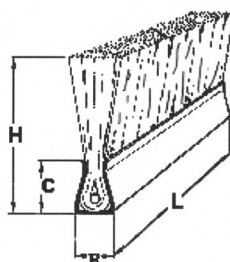
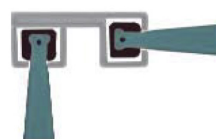
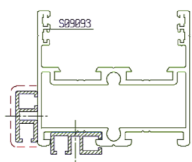





			REF.
1	2.500mm	-	H9010
1	2.500mm	16mm	H9016
1	2.500mm	20mm	H9020
1	2.500mm	25mm	H9025
1	2.500mm	35mm	H9035



TIENDA



Bajopuertas automáticos series PVC 11,8mm

			R
10	300mm	11,8mm	63
10	400mm	11,8mm	94004
10	500mm	11,8mm	94683
10	600mm	11,8mm	96119
10	700mm	11,8mm	94684
10	800mm	11,8mm	88
10	900mm	11,8mm	88
10	1.000mm	11,8mm	88
			1.100mm 11,8mm 92
			1.200mm 11,8mm 94
10	1.300mm	11,8mm	94

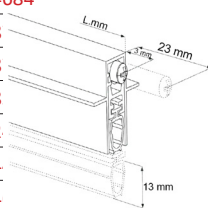
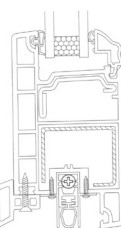

TIENDA

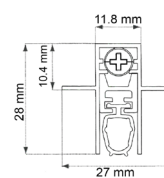

Bajopuertas automáticos series Aluminio 20mm

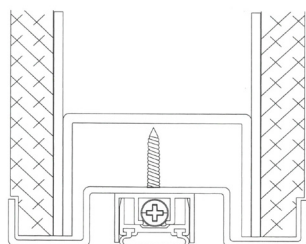
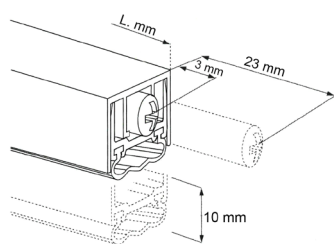

			REF.
10	500mm	20mm	99201
10	600mm	20mm	99190
10	700mm	20mm	99191
10	800mm	20mm	99068
10	900mm	20mm	98003
10	1.000mm	20mm	99202
10	1.100mm	20mm	99192
10	1.200mm	20mm	94782

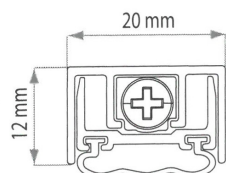

TIENDA



Bajopuertas automático guiado series Aluminio 24mm

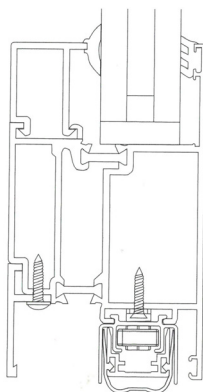
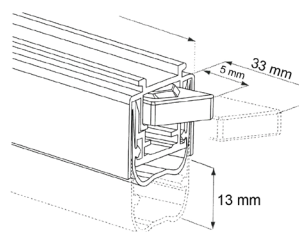

			REF.
10	400mm	24mm	99114
10	500mm	24mm	85234
10	600mm	24mm	85235
10	700mm	24mm	98756
10	800mm	24mm	85236
10	900mm	24mm	98309
10	1.000mm	24mm	99170
10	1.100mm	24mm	94137
10	1.200mm	24mm	99120

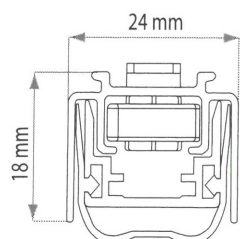

TIENDA



Bajopuertas automático recto series Aluminio 24mm

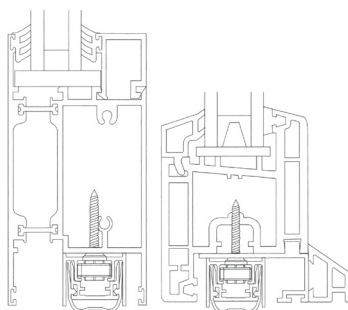
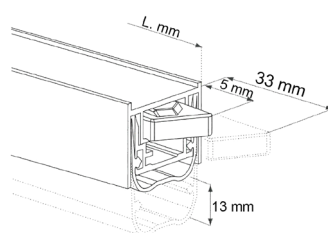

			REF.
10	400mm	24mm	99389
10	500mm	24mm	99388
10	600mm	24mm	98359
10	700mm	24mm	98330
10	800mm	24mm	98329
10	900mm	24mm	99049
10	1.000mm	24mm	99263
10	1.100mm	24mm	88143
10	1.200mm	24mm	99521
10	1.300mm	24mm	99554
10	1.400mm	24mm	94679
10	1.500mm	24mm	94680

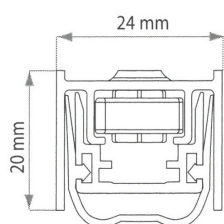

TIENDA

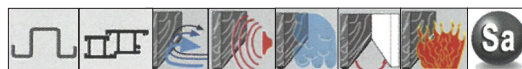

Bajopuertas automáticos series Aluminio 38mm

			REF.
10	400mm	38mm	94672
10	500mm	38mm	94673
10	600mm	38mm	98360
10	700mm	38mm	88604
10	800mm	38mm	88737
10	900mm	38mm	88142
10	1.000mm	38mm	98217
10	1.100mm	38mm	98334
10	1.200mm	38mm	88341
10	1.300mm	38mm	94674
10	1.400mm	38mm	94675
10	1.500mm	38mm	94676

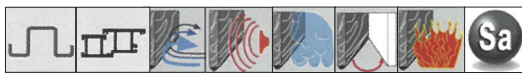
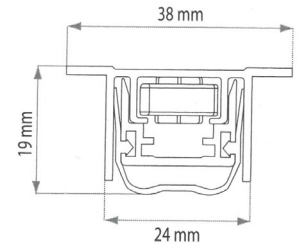
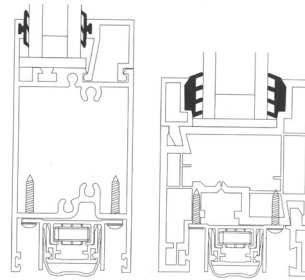

TIENDA



Bajopuertas automático superpuesto

			REF.
10	400mm	Blanco	95477
10	500mm	Blanco	94695
10	600mm	Blanco	94696
10	700mm	Blanco	95323
10	800mm	Blanco	96147
10	900mm	Blanco	95293
10	1.000mm	Blanco	99902
10	1.100mm	Blanco	96280
10	1.200mm	Blanco	94697
10	1.300mm	Blanco	94698
10	400mm	Negro	94699
10	500mm	Negro	94700
10	600mm	Negro	94701
10	700mm	Negro	94702
10	800mm	Negro	92431
10	900mm	Negro	92357
10	1.000mm	Negro	99938
10	1.100mm	Negro	92435
10	1.200mm	Negro	94703
10	1.300mm	Negro	92432

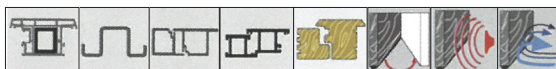
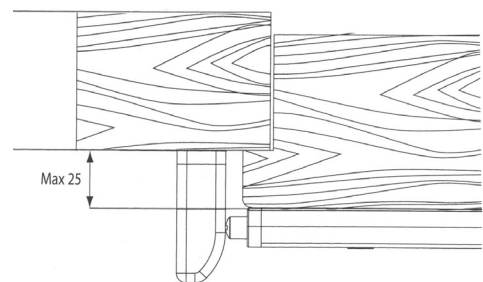
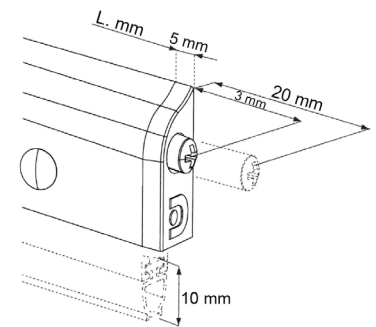
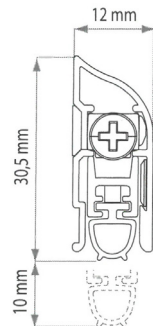

TIENDA





Tornillo para **PVC** punta broca zincado

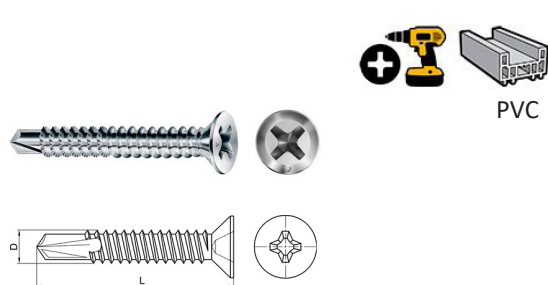

TIENDA



	TIPO			REF.
1.000	PH	3,9 x 13	Zinc	T1100
1.000	PH	3,9 x 16	Zinc	T1101
1.000	PH	3,9 x 19	Zinc	T1102
1.000	PH	3,9 x 25	Zinc	T1103
1.000	PH	3,9 x 32	Zinc	T1104
1.000	PH	3,9 x 38	Zinc	T1105



Tornillo para **PVC** rosca HI-LO zincado

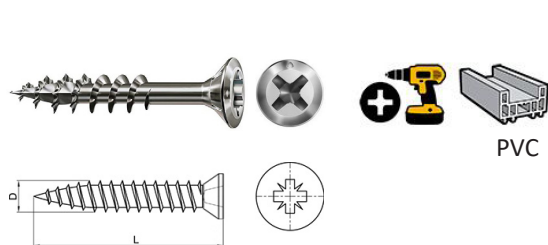

TIENDA



	TIPO			REF.
1.000	PH	4,0 x 16	Zinc	T1000
1.000	PH	4,0 x 20	Zinc	T1001
1.000	PH	4,0 x 22	Zinc	T1002
1.000	PH	4,0 x 25	Zinc	T1003
1.000	PH	4,0 x 30	Zinc	T1004
1.000	PH	4,0 x 35	Zinc	T1005
1.000	PH	4,0 x 40	Zinc	T1006
1.000	PH	4,0 x 45	Zinc	T1007
1.000	PH	4,0 x 50	Zinc	T1008



Tornillo DIN 9670 para **PVC** cabeza avellanada 7,5mm rosca HI-LO

PVC

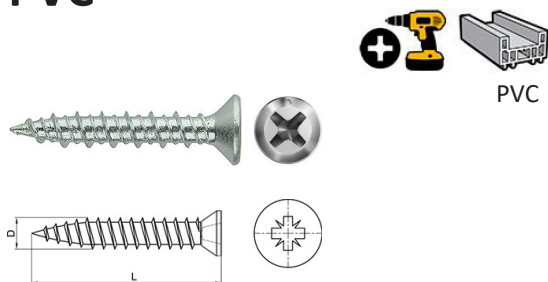

TIENDA



	TIPO			REF.
1.000	PH	3,9 x 25	Zinc	T9670 ●
1.000	PH	3,9 x 30	Zinc	T9671
500	PH	3,9 x 38	Zinc	T9672
500	PH	3,9 x 45	Zinc	T9673

● Medida especial para banco de herraje **SKY-2000** de Starker



Tornillo DIN 9765 para **PVC** cabeza avellanada 7,5mm r. métrica

PVC

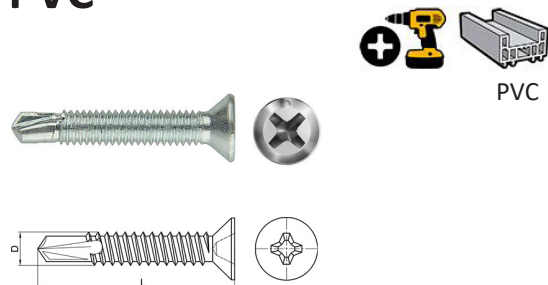



TIENDA



	TIPO			REF.
1.000	PH	M-4 x 13	Zinc	T9675
1.000	PH	M-4 x 16	Zinc	T9676
1.000	PH	M-4 x 19	Zinc	T9677 ●
1.000	PH	M-4 x 25	Zinc	T9678
1.000	PH	M-4 x 32	Zinc	T9679

● Medida especial para atornillador automático vertical **Halcón-II** de Starker

Tornillo cierre punta broca PH2

	TIPO			REF.
500	PH2	4,2 x 14	Zincado	H8876
500	PH2	4,2 x 23	Zincado	H8877
500	PH2	4,2 x 14	Zinc. negro	H8878
500	PH2	4,2 x 23	Zinc. negro	H8879
500	PH2	4,2 x 14	Cab. Blanca	H8882
500	PH2	4,2 x 23	Cab. Blanca	H8883

TIENDA





Tornillo p/cierre rosca HI-LO cabeza plana PH2

	TIPO			REF.
500	PH2	4,2 x 13	Zincado	H8884
500	PH2	4,2 x 22	Zincado	H8885
500	PH2	4,2 x 32	Zincado	H8886
500	PH2	4,2 x 13	Zinc. negro	H8887
500	PH2	4,2 x 22	Zinc. negro	H8888
500	PH2	4,2 x 32	Zinc. negro	H8889
500	PH2	4,2 x 13	Blanco	H8890
500	PH2	4,2 x 22	Blanco	H8891
500	PH2	4,2 x 32	Blanco	H8892

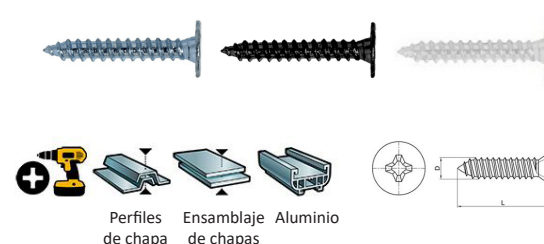
TIENDA



Tornillo junquillo KO zincado (Kömmerling)



	TIPO			REF.
250	KO	5,5 x 10	Zinc	56525

TIENDA



PVC

Tornillo junquillo RH zincado (Rehau)



	TIPO			REF.
250	RH	5,5 x 12	Zinc	56526

TIENDA



PVC

Tornillo junquillo TY zincado (Tyssen)



	TIPO			REF.
250	TY	5,5 x 12	Zinc	94466

TIENDA



PVC

Tornillo junquillo VK zincado (Veka)

	TIPO			REF.
250	VK	4,8 x 9,5	Zinc	30503

TIENDA



PVC

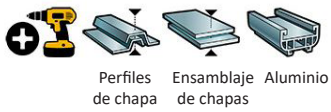
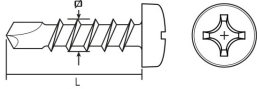



Tornillo DIN 7504-N PH2 zincado

	TIPO			REF.
1.000	PH2	3,5 x 9,5	Zinc	H8893
1.000	PH2	3,5 x 11	Zinc	H8894
1.000	PH2	3,5 x 13	Zinc	H8895
1.000	PH2	3,5 x 16	Zinc	H8896
1.000	PH2	3,5 x 19	Zinc	H8897
1.000	PH2	3,5 x 22	Zinc	H8898
500	PH2	3,5 x 25	Zinc	H8899
500	PH2	3,5 x 32	Zinc	H8900
1.000	PH2	3,9 x 13	Zinc	H8901
1.000	PH2	3,9 x 16	Zinc	H8902
1.000	PH2	3,9 x 19	Zinc	H8903
500	PH2	3,9 x 25	Zinc	H8904
500	PH2	3,9 x 32	Zinc	H8905
1.000	PH2	4,2 x 13	Zinc	H8906
1.000	PH2	4,2 x 16	Zinc	H8907
1.000	PH2	4,2 x 19	Zinc	H8908
500	PH2	4,2 x 22	Zinc	H8909
500	PH2	4,2 x 25	Zinc	H8910
500	PH2	4,2 x 32	Zinc	H8911
500	PH2	4,2 x 38	Zinc	H8912
500	PH2	4,2 x 50	Zinc	H8913
1.000	PH2	4,8 x 13	Zinc	H8914
1.000	PH2	4,8 x 16	Zinc	H8915
1.000	PH2	4,8 x 19	Zinc	H8916
500	PH2	4,8 x 22	Zinc	H8917
500	PH2	4,8 x 25	Zinc	H8918
500	PH2	4,8 x 32	Zinc	H8919
500	PH2	4,8 x 38	Zinc	H8920
500	PH2	4,8 x 45	Zinc	H8921
500	PH2	4,8 x 50	Zinc	H8922
500	PH2	4,8 x 60	Zinc	H8923
250	PH2	4,8 x 70	Zinc	H8924
250	PH2	4,8 x 80	Zinc	H8925
100	PH2	4,8 x 90	Zinc	H8926
100	PH2	4,8 x 100	Zinc	H8927
100	PH2	4,8 x 110	Zinc	H8928
100	PH2	4,8 x 120	Zinc	H8929
500	PH2	5,5 x 19	Zinc	H8930
500	PH2	5,5 x 22	Zinc	H8931
500	PH2	5,5 x 25	Zinc	H8932
500	PH2	5,5 x 32	Zinc	H8933
500	PH2	5,5 x 38	Zinc	H8934
500	PH2	5,5 x 45	Zinc	H8935
250	PH2	5,5 x 60	Zinc	H8936
250	PH2	5,5 x 73	Zinc	H8937

TIENDA



Tornillo DIN 7504-N PH2 zincado negro

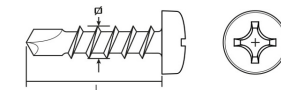

	TIPO			REF.
1.000	PH2	3,5 x 9,5	Negro	H8938
1.000	PH2	3,5 x 13	Negro	H8939
1.000	PH2	3,5 x 16	Negro	H8940
1.000	PH2	3,5 x 19	Negro	H8941
1.000	PH2	4,2 x 13	Negro	H8942
1.000	PH2	4,2 x 16	Negro	H8943
1.000	PH2	4,2 x 19	Negro	H8944
500	PH2	4,2 x 25	Negro	H8945
500	PH2	4,2 x 32	Negro	H8946
500	PH2	4,2 x 38	Negro	H8947
1.000	PH2	4,8 x 16	Negro	H8948
1.000	PH2	4,8 x 19	Negro	H8949
500	PH2	4,8 x 25	Negro	H8950
500	PH2	4,8 x 32	Negro	H8951
500	PH2	4,8 x 38	Negro	H8952
500	PH2	4,8 x 45	Negro	H8953
500	PH2	4,8 x 50	Negro	H8954



TIENDA



Tornillo DIN 7504-N Torx zincado

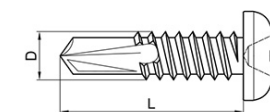

	TIPO			REF.
1.000	TX	3,5 x 9,5	Zinc	H8955
1.000	TX	3,5 x 13	Zinc	H8956
1.000	TX	3,5 x 16	Zinc	H8957
1.000	TX	3,5 x 19	Zinc	H8958
1.000	TX	4,2 x 13	Zinc	H8959
1.000	TX	4,2 x 16	Zinc	H8960
1.000	TX	4,2 x 19	Zinc	H8961
500	TX	4,2 x 25	Zinc	H8962
1.000	TX	4,8 x 16	Zinc	H8963
1.000	TX	4,8 x 19	Zinc	H8964
500	TX	4,8 x 25	Zinc	H8965
500	TX	4,8 x 32	Zinc	H8966
500	TX	4,8 x 38	Zinc	H8967
500	TX	4,8 x 45	Zinc	H8968
500	TX	4,8 x 50	Zinc	H8969
500	TX	4,8 x 60	Zinc	H8970
250	TX	4,8 x 70	Zinc	H8971



TIENDA



Tornillo DIN 7504-P PH2 zincado

	TIPO			REF.
1.000	PH2	3,5 x 9,5	Zinc	H8978
1.000	PH2	3,5 x 11	Zinc	H8979
1.000	PH2	3,5 x 13	Zinc	H8980
1.000	PH2	3,5 x 16	Zinc	H8981
1.000	PH2	3,5 x 19	Zinc	H8982
1.000	PH2	3,5 x 22	Zinc	H8983
500	PH2	3,5 x 25	Zinc	H8984
1.000	PH2	3,9 x 13	Zinc	H8985
1.000	PH2	3,9 x 16	Zinc	H8986
1.000	PH2	3,9 x 19	Zinc	H8987
500	PH2	3,9 x 22	Zinc	H8988

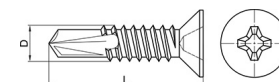

TIENDA



CONTINÚA EN LA SIGUIENTE PÁGINA

Tornillo DIN 7504-P PH2 zincado (Continuación)

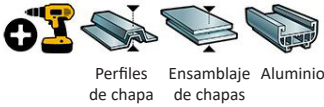
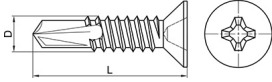

	TIPO			REF.
VIENE DE LA PÁGINA ANTERIOR				
500	PH2	3,9 x 25	Zinc	H8989
500	PH2	3,9 x 32	Zinc	H8990
500	PH2	3,9 x 38	Zinc	H8991
1.000	PH2	4,2 x 13	Zinc	H8992
1.000	PH2	4,2 x 16	Zinc	H8993
1.000	PH2	4,2 x 19	Zinc	H8994
500	PH2	4,2 x 22	Zinc	H8995
500	PH2	4,2 x 25	Zinc	H8996
500	PH2	4,2 x 32	Zinc	H8997
500	PH2	4,2 x 38	Zinc	H8998
1.000	PH2	4,8 x 13	Zinc	H8999
1.000	PH2	4,8 x 16	Zinc	H9000
1.000	PH2	4,8 x 19	Zinc	H9040
500	PH2	4,8 x 22	Zinc	H9041
500	PH2	4,8 x 25	Zinc	H9042
500	PH2	4,8 x 32	Zinc	H9043
500	PH2	4,8 x 38	Zinc	H9044
500	PH2	4,8 x 45	Zinc	H9045
500	PH2	4,8 x 50	Zinc	H9046
500	PH2	4,8 x 60	Zinc	H9047
250	PH2	4,8 x 70	Zinc	H9048
250	PH2	4,8 x 80	Zinc	H9049
500	PH2	5,5 x 19	Zinc	H9050
500	PH2	5,5 x 25	Zinc	H9051
500	PH2	5,5 x 32	Zinc	H9052
500	PH2	5,5 x 38	Zinc	H9053
500	PH2	5,5 x 50	Zinc	H9054
250	PH2	5,5 x 60	Zinc	H9055
250	PH2	5,5 x 70	Zinc	H9056
250	PH2	5,5 x 80	Zinc	H9057

TIENDA



Tornillo DIN 7504-P PH2 zincado negro

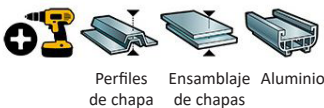
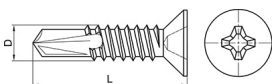



	TIPO			REF.
1.000	PH2	3,5 x 13	Negro	H9058
1.000	PH2	3,5 x 16	Negro	H9059
1.000	PH2	3,5 x 19	Negro	H9060
500	PH2	3,5 x 25	Negro	H9061
1.000	PH2	4,2 x 16	Negro	H9062
1.000	PH2	4,2 x 19	Negro	H9063
500	PH2	4,2 x 25	Negro	H9064
500	PH2	4,2 x 32	Negro	H9065
500	PH2	4,2 x 38	Negro	H9066
500	PH2	4,8 x 25	Negro	H9067
500	PH2	4,8 x 32	Negro	H9068
500	PH2	4,8 x 38	Negro	H9069
500	PH2	4,8 x 50	Negro	H9070

TIENDA



Tornillo DIN 7981 r. chapa zincado

	TIPO			REF.
1.000	PH	2,9 x 6,5	Zinc	T9000
1.000	PH	2,9 x 9,5	Zinc	T9001
1.000	PH	2,9 x 13	Zinc	T9002
1.000	PH	2,9 x 16	Zinc	T9003
1.000	PH	2,9 x 19	Zinc	T9004
1.000	PH	2,9 x 22	Zinc	T9005
500	PH	2,9 x 25	Zinc	T9006
1.000	PH	3,5 x 6,5	Zinc	T9007
1.000	PH	3,5 x 9,5	Zinc	T9008
500	PH	3,5 x 13	Zinc	T9009
500	PH	3,5 x 16	Zinc	T9010
500	PH	3,5 x 19	Zinc	T9011
250	PH	3,5 x 25	Zinc	T9012
250	PH	3,5 x 32	Zinc	T9013
500	PH	3,9 x 9,5	Zinc	T9014
500	PH	3,9 x 13	Zinc	T9015
500	PH	3,9 x 16	Zinc	T9016
500	PH	3,9 x 19	Zinc	T9017
250	PH	3,9 x 22	Zinc	T9018
250	PH	3,9 x 25	Zinc	T9019
250	PH	3,9 x 32	Zinc	T9020
250	PH	3,9 x 38	Zinc	T9021
250	PH	3,9 x 45	Zinc	T9022
250	PH	3,9 x 50	Zinc	T9023
500	PH	4,2 x 9,5	Zinc	T9024
500	PH	4,2 x 13	Zinc	T9025
500	PH	4,2 x 16	Zinc	T9026
500	PH	4,2 x 19	Zinc	T9027
250	PH	4,2 x 22	Zinc	T9028
250	PH	4,2 x 25	Zinc	T9030
250	PH	4,2 x 32	Zinc	T9031
250	PH	4,2 x 38	Zinc	T9032
250	PH	4,2 x 45	Zinc	T9033
250	PH	4,2 x 50	Zinc	T9034
250	PH	4,2 x 60	Zinc	T9035
250	PH	4,2 x 70	Zinc	T9036
250	PH	4,2 x 80	Zinc	T9037
250	PH	4,2 x 90	Zinc	T9038
500	PH	4,8 x 9,5	Zinc	T9039
500	PH	4,8 x 13	Zinc	T9040
250	PH	4,8 x 16	Zinc	T9041
250	PH	4,8 x 19	Zinc	T9042
250	PH	4,8 x 22	Zinc	T9043
250	PH	4,8 x 25	Zinc	T9044
250	PH	4,8 x 32	Zinc	T9045
250	PH	4,8 x 38	Zinc	T9046
250	PH	4,8 x 45	Zinc	T9047
250	PH	4,8 x 50	Zinc	T9048
250	PH	4,8 x 60	Zinc	T9049
100	PH	4,8 x 70	Zinc	T9050
100	PH	4,8 x 80	Zinc	T9051
100	PH	4,8 x 90	Zinc	T9052
100	PH	4,8 x 100	Zinc	T9053
100	PH	4,8 x 110	Zinc	T9054
100	PH	4,8 x 120	Zinc	T9055
250	PH	5,5 x 13	Zinc	T9056

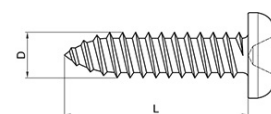

Perfiles de chapa Ensamblaje de chapas Aluminio

CONTINÚA EN LA SIGUIENTE PÁGINA

TIENDA



Tornillo DIN 7981 r. chapa zincado (Continuación)

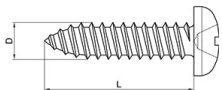
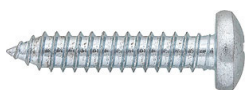

	TIPO			REF.
VIENE DE LA PÁGINA ANTERIOR				
250	PH	5,5 x 16	Zinc	T9057
250	PH	5,5 x 19	Zinc	T9058
250	PH	5,5 x 22	Zinc	T9059
250	PH	5,5 x 25	Zinc	T9060
250	PH	5,5 x 32	Zinc	T9061
250	PH	5,5 x 38	Zinc	T9062
250	PH	5,5 x 45	Zinc	T9063
250	PH	5,5 x 50	Zinc	T9064
100	PH	5,5 x 60	Zinc	T9065
100	PH	5,5 x 70	Zinc	T9066
100	PH	5,5 x 80	Zinc	T9067
100	PH	5,5 x 90	Zinc	T9068
100	PH	5,5 x 100	Zinc	T9069
100	PH	5,5 x 110	Zinc	T9070
100	PH	5,5 x 120	Zinc	T9071
250	PH	6,3 x 16	Zinc	T9072
250	PH	6,3 x 19	Zinc	T9073
250	PH	6,3 x 22	Zinc	T9074
250	PH	6,3 x 25	Zinc	T9075
250	PH	6,3 x 32	Zinc	T9076
250	PH	6,3 x 38	Zinc	T9077
250	PH	6,3 x 45	Zinc	T9078
250	PH	6,3 x 50	Zinc	T9079
100	PH	6,3 x 60	Zinc	T9080
100	PH	6,3 x 70	Zinc	T9081
100	PH	6,3 x 80	Zinc	T9082
50	PH	6,3 x 90	Zinc	T9083
50	PH	6,3 x 100	Zinc	T9084
50	PH	6,3 x 110	Zinc	T9085
50	PH	6,3 x 120	Zinc	T9086



Tornillo DIN 7982 r. chapa zincado

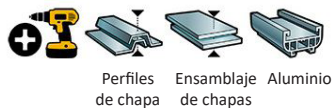
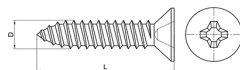
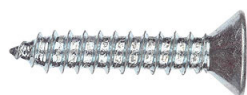



	TIPO			REF.
1.000	PH	2,9 x 6,5	Zinc	T9500
1.000	PH	2,9 x 9,5	Zinc	T9501
1.000	PH	2,9 x 13	Zinc	T9502
1.000	PH	2,9 x 16	Zinc	T9503
1.000	PH	2,9 x 19	Zinc	T9504
1.000	PH	2,9 x 22	Zinc	T9505
500	PH	2,9 x 25	Zinc	T9506
1.000	PH	3,5 x 9,5	Zinc	T9507
500	PH	3,5 x 13	Zinc	T9508
500	PH	3,5 x 16	Zinc	T9509
500	PH	3,5 x 19	Zinc	T9510
500	PH	3,5 x 22	Zinc	T9511
250	PH	3,5 x 25	Zinc	T9512
250	PH	3,5 x 32	Zinc	T9513
250	PH	3,5 x 38	Zinc	T9514
500	PH	3,9 x 9,5	Zinc	T9515
500	PH	3,9 x 13	Zinc	T9516
500	PH	3,9 x 16	Zinc	T9517

CONTINÚA EN LA SIGUIENTE PÁGINA



Tornillo DIN 7982 r. chapa zincado (Continuación)

	TIPO			REF.
VIENE DE LA PÁGINA ANTERIOR				
500	PH	3,9 x 19	Zinc	T9518
250	PH	3,9 x 22	Zinc	T9519
250	PH	3,9 x 25	Zinc	T9520
250	PH	3,9 x 32	Zinc	T9521
250	PH	3,9 x 38	Zinc	T9522
250	PH	3,9 x 45	Zinc	T9523
250	PH	3,9 x 50	Zinc	T9524
500	PH	4,2 x 13	Zinc	T9525
500	PH	4,2 x 16	Zinc	T9526
500	PH	4,2 x 19	Zinc	T9527
250	PH	4,2 x 22	Zinc	T9528
250	PH	4,2 x 25	Zinc	T9529
250	PH	4,2 x 32	Zinc	T9530
250	PH	4,2 x 38	Zinc	T9531
250	PH	4,2 x 45	Zinc	T9532
250	PH	4,2 x 50	Zinc	T9533
250	PH	4,2 x 60	Zinc	T9534
250	PH	4,2 x 70	Zinc	T9535
500	PH	4,8 x 13	Zinc	T9536
250	PH	4,8 x 16	Zinc	T9537
250	PH	4,8 x 19	Zinc	T9538
250	PH	4,8 x 22	Zinc	T9539
250	PH	4,8 x 25	Zinc	T9540
250	PH	4,8 x 32	Zinc	T9541
250	PH	4,8 x 38	Zinc	T9542
250	PH	4,8 x 45	Zinc	T9543
250	PH	4,8 x 50	Zinc	T9545
250	PH	4,8 x 60	Zinc	T9546
100	PH	4,8 x 70	Zinc	T9547
250	PH	5,5 x 13	Zinc	T9548
250	PH	5,5 x 16	Zinc	T9549
250	PH	5,5 x 19	Zinc	T9550
250	PH	5,5 x 22	Zinc	T9551
250	PH	5,5 x 25	Zinc	T9552
250	PH	5,5 x 32	Zinc	T9553
250	PH	5,5 x 38	Zinc	T9554
250	PH	5,5 x 45	Zinc	T9555
250	PH	5,5 x 50	Zinc	T9556
100	PH	5,5 x 60	Zinc	T9557
100	PH	5,5 x 70	Zinc	T9558
250	PH	6,3 x 25	Zinc	T9559
250	PH	6,3 x 32	Zinc	T9560
250	PH	6,3 x 38	Zinc	T9561
250	PH	6,3 x 45	Zinc	T9562
250	PH	6,3 x 50	Zinc	T9563
100	PH	6,3 x 60	Zinc	T9564
100	PH	6,3 x 70	Zinc	T9565

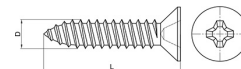

TIENDA



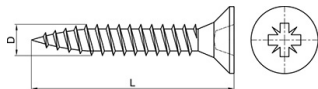

Madera Madera fina

Tirafondo pozidriv bricomatado

Ideal para tacos de nylon o madera

	TIPO		€	REF.
1.000	PZ	2,5 x 10	0,015 € /ud.	T9600
1.000	PZ	2,5 x 12	0,015 € /ud.	T9601
1.000	PZ	2,5 x 16	0,017 € /ud.	T9602
1.000	PZ	2,5 x 20	0,019 € /ud.	T9604
1.000	PZ	2,5 x 25	0,020 € /ud.	T9605
1.000	PZ	3,0 x 12	0,013 € /ud.	T9606
1.000	PZ	3,0 x 16	0,014 € /ud.	T9607
1.000	PZ	3,0 x 20	0,017 € /ud.	T9608
1.000	PZ	3,0 x 25	0,019 € /ud.	T9609
1.000	PZ	3,0 x 30	0,021 € /ud.	T9610
1.000	PZ	3,0 x 40	0,028 € /ud.	T9611
1.000	PZ	3,5 x 16	0,016 € /ud.	T9612
1.000	PZ	3,5 x 20	0,020 € /ud.	T9613
1.000	PZ	3,5 x 25	0,022 € /ud.	T9614
1.000	PZ	3,5 x 30	0,025 € /ud.	T9615
500	PZ	3,5 x 35	0,029 € /ud.	T9616
500	PZ	3,5 x 40	0,034 € /ud.	T9617
250	PZ	3,5 x 50	0,043 € /ud.	T9618
1.000	PZ	4,0 x 16	0,021 € /ud.	T9619
1.000	PZ	4,0 x 20	0,025 € /ud.	T9620
1.000	PZ	4,0 x 25	0,027 € /ud.	T9621
500	PZ	4,0 x 30	0,027 € /ud.	T9622
500	PZ	4,0 x 35	0,038 € /ud.	T9623
500	PZ	4,0 x 40	0,039 € /ud.	T9624
500	PZ	4,0 x 45	0,047 € /ud.	T9625
250	PZ	4,0 x 50	0,054 € /ud.	T9626
250	PZ	4,0 x 60	0,058 € /ud.	T9627
250	PZ	4,0 x 70	0,075 € /ud.	T9628
500	PZ	4,5 x 20	0,030 € /ud.	T9629
500	PZ	4,5 x 25	0,036 € /ud.	T9630
500	PZ	4,5 x 30	0,042 € /ud.	T9631
500	PZ	4,5 x 35	0,046 € /ud.	T9632
500	PZ	4,5 x 40	0,052 € /ud.	T9633
250	PZ	4,5 x 45	0,062 € /ud.	T9634
250	PZ	4,5 x 50	0,067 € /ud.	T9635
250	PZ	4,5 x 60	0,079 € /ud.	T9336
250	PZ	4,5 x 70	0,099 € /ud.	T9637
100	PZ	4,5 x 80	0,099 € /ud.	T9638
500	PZ	5,0 x 20	0,038 € /ud.	T9639
500	PZ	5,0 x 25	0,044 € /ud.	T9640
250	PZ	5,0 x 30	0,052 € /ud.	T9641
250	PZ	5,0 x 35	0,061 € /ud.	T9642
250	PZ	5,0 x 40	0,068 € /ud.	T9643
250	PZ	5,0 x 45	0,076 € /ud.	T9644
250	PZ	5,0 x 50	0,079 € /ud.	T9645
250	PZ	5,0 x 60	0,094 € /ud.	T9646
100	PZ	5,0 x 70	0,119 € /ud.	T9647
100	PZ	5,0 x 80	0,132 € /ud.	T9648
100	PZ	5,0 x 90	0,161 € /ud.	T9649
100	PZ	5,0 x 100	0,169 € /ud.	T9650
100	PZ	5,0 x 120	0,169 € /ud.	T9651
250	PZ	6,0 x 40	0,094 € /ud.	T9652
250	PZ	6,0 x 50	0,112 € /ud.	T9653
250	PZ	6,0 x 60	0,128 € /ud.	T9654
100	PZ	6,0 x 70	0,178 € /ud.	T9655
100	PZ	6,0 x 80	0,192 € /ud.	T9656

CONTINÚA EN LA SIGUIENTE PÁGINA

TIENDA



Tirafondo pozidriv bricomatado (Continuación)



Ideal para tacos de nylon o madera

	TIPO			REF.
VIENE DE LA PÁGINA ANTERIOR				
100	PZ	6,0 x 90	Bricomatado	T9657
100	PZ	6,0 x 100	Bricomatado	T9658
100	PZ	6,0 x 110	Bricomatado	T9659
100	PZ	6,0 x 120	Bricomatado	T9660
100	PZ	6,0 x 130	Bricomatado	T9661
100	PZ	6,0 x 140	Bricomatado	T9662
100	PZ	6,0 x 150	Bricomatado	T9663
100	PZ	6,0 x 160	Bricomatado	T9664
100	PZ	6,0 x 180	Bricomatado	T9665
100	PZ	6,0 x 200	Bricomatado	T9666
100	PZ	6,0 x 220	Bricomatado	T9667

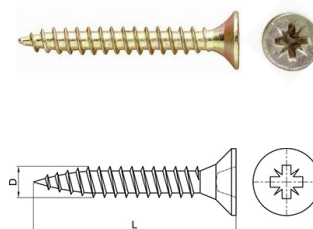
TIENDA





Tornillo TX-30 para hormigón broca 6mm con cabeza plana Torx

	TIPO	BROCA			REF.
100	TX-30	∅ 6	7,5 x 72	Zinc	H8839
100	TX-30	∅ 6	7,5 x 92	Zinc	H8840
100	TX-30	∅ 6	7,5 x 112	Zinc	H8841
100	TX-30	∅ 6	7,5 x 132	Zinc	H8842
100	TX-30	∅ 6	7,5 x 152	Zinc	H8843
100	TX-30	∅ 6	7,5 x 182	Zinc	H8844
100	TX-30	∅ 6	7,5 x 212	Zinc	H8845

TIENDA





Tornillo TX-30 para hormigón broca 6mm con cabeza cilíndrica Torx

	TIPO	BROCA			REF.
100	TX-30	∅ 6	7,5 x 72	Zinc	H8846
100	TX-30	∅ 6	7,5 x 92	Zinc	H8847
100	TX-30	∅ 6	7,5 x 112	Zinc	H8848
100	TX-30	∅ 6	7,5 x 132	Zinc	H8849

TIENDA



Tapones de PVC para tornillos de hormigón TX-30

	∅		REF.
1.000	13 / 4	Blanco	H8850
1.000	13 / 4	Negro	H8851



TIENDA

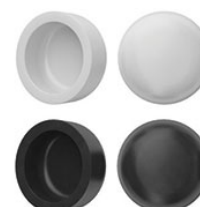



Bloque de hormigón Hormigón ligero Hormigón armado Hormigón armado





Piedra Ladrillo de adobe Ladrillo Hueco Ladrillo macizo

TIENDA



Tacos clavable cabeza avellanada

		REF.
100	5 x 25	H7950
100	5 x 30	H7951
100	5 x 35	H7952
100	5 x 50	H7953
100	6 x 35	H7954
100	6 x 40	H7955
100	6 x 50	H7956
100	6 x 60	H7957
100	6 x 70	H7958
100	6 x 80	H7959
100	8 x 60	H7960
100	8 x 80	H7961
100	8 x 100	H7962
100	8 x 120	H7963
100	8 x 140	H7964



Bloque de hormigón Hormigón ligero Hormigón armado Hormigón armado





Piedra Ladrillo de adobe Ladrillo Hueco Ladrillo macizo

TIENDA



Tacos clavable cabeza cilíndrica



		REF.
100	5 x 25	H7965
100	5 x 30	H7966
100	5 x 35	H7967
100	5 x 50	H7968
100	6 x 35	H7969
100	6 x 40	H7970
100	6 x 50	H7971
100	6 x 60	H7972
100	6 x 70	H7973
100	8 x 60	H7974
100	8 x 80	H7975
100	8 x 100	H7976
100	8 x 120	H7977
100	8 x 140	H7978



Panel de pladur

Tacos para pladur

Tipo rosca, de nylon



		REF.
100	15 x 33	H8700

TIENDA



Tacos de nylon con collarín

Resistente a temperaturas entre -50°C y +75°C



		REF.
200	5 x 25	H8803
100	6 x 30	H8804
100	8 x 40	H8805
50	10 x 50	H8806

TIENDA



Tacos de nylon sin collarín

Resistente a temperaturas entre -50°C y +75°C



		REF.
200	5 x 25	H8797
100	6 x 30	H8798
100	8 x 40	H8799
50	10 x 50	H8800
25	12 x 60	H8801
20	14 x 80	H8802

TIENDA



Tacos de nylon nudo

Abertura lateral para mayor expansión, resistente a temperaturas entre -40°C y +80°C



		REF.
100	5 x 25	H8791
100	6 x 30	H8792
100	8 x 40	H8793
50	10 x 50	H8794
25	12 x 60	H8795
20	14 x 80	H8796

TIENDA



Tacos Duopower

Soporta un 25% mas de carga, adecuado para cavidades reducidas

		REF.
100	5 x 25	H8750
100	6 x 30	H8751
100	8 x 40	H8752
50	10 x 50	H8753
25	12 x 60	H8754

TIENDA

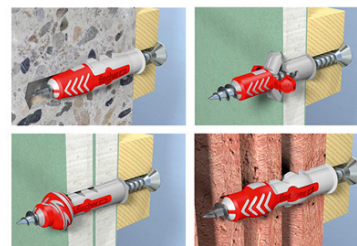

Vídeo demostración

Base cuadrada de aluminio para tubo

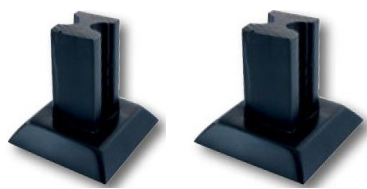

30 x 30

40 x 40

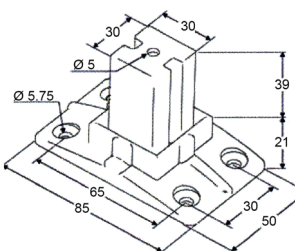

TIENDA



			REF.
20	30 x 30	Blanco	H3000-9016
20	30 x 30	Negro	H3000-9005
20	30 x 30	Bruto	H3000-BRUTO
20	30 x 30 con tapa	Blanco	H3001-9016
20	30 x 30 con tapa	Negro	H3001-9005
20	40 x 40	Blanco	H3002-9016
20	40 x 40	Negro	H3002-9005
20	40 x 40	Bruto	H3002-BRUTO
20	40 x 40 con tapa	Blanco	H3003-9016
20	40 x 40 con tapa	Negro	H3003-9005

Multi-Base de aluminio para tubo



Cada Multi-Base sirve para 3 medidas distintas de tubo. En los tubos redondos su colocación podrá ser interior o exterior, y en el caso de los tubos cuadrados siempre será exterior.

TIENDA



				REF.
9	50 x 50	30 / 50	Blanco	H3010-9016
9	50 x 50	30 / 50	Negro	H3010-9005
9	50 x 50	30 / 50	Especial	H3010-RAL
6	60 x 60	40 / 60	Blanco	H3011-9016
6	60 x 60	40 / 60	Negro	H3011-9005
6	60 x 60	40 / 60	Especial	H3011-RAL
6	60 x 60	-	Blanco	H3012-9016
6	60 x 60	-	Negro	H3012-9005
6	60 x 60	-	Especial	H3012-RAL
6	70 x 70	-	Blanco	H3013-9016
6	70 x 70	-	Negro	H3013-9005
6	70 x 70	-	Especial	H3013-RAL
4	80 x 80	-	Blanco	H3014-9016
4	80 x 80	-	Negro	H3014-9005
4	80 x 08	-	Especial	H3014-RAL
4	100 x 100	80 / 100	Blanco	H3015-9016
4	100 x 100	80 / 100	Negro	H3015-9005
4	100 x 100	80 / 100	Especial	H3015-RAL

Base y fijador de barandilla desplazada



30 x 30

40 x 20



TIENDA



	DESCRIPCIÓN			REF.
10	Base desplazada	30 x 30	Blanco	H3016-9016
10	Base desplazada	30 x 30	Negro	H3016-9005
10	Base desplazada	30 x 30	Especial	H3016-RAL
10	Base desplazada	40 x 20	Blanco	H3017-9016
10	Base desplazada	40 x 20	Negro	H3017-9005
10	Base desplazada	40 x 20	Especial	H3017-RAL
10	Fijador barandilla	-	Blanco	H3018-9016
10	Fijador barandilla	-	Negro	H3018-9005
10	Fijador barandilla	-	Especial	H3018-RAL

Embellecedor de aluminio

			REF.
50	40 x 20	Blanco	H3023-9016
50	40 x 20	Negro	H3023-9005
50	40 x 20	Especial	H3023-RAL
50	30 x 30	Blanco	H3025-9016
50	30 x 30	Negro	H3025-9005
50	30 x 30	Especial	H3025-RAL
50	40 x 40	Blanco	H3026-9016
50	40 x 40	Negro	H3026-9005
50	40 x 40	Especial	H3026-RAL
50	60 x 60	Blanco	H3028-9016
50	60 x 60	Negro	H3028-9005
50	60 x 60	Especial	H3028-RAL
50	70 x 70	Blanco	H3029-9016
50	70 x 70	Negro	H3029-9005
50	70 x 70	Especial	H3029-RAL
50	100 x 100	Blanco	H3030-9016
50	100 x 100	Negro	H3030-9005
50	100 x 100	Especial	H3030-RAL

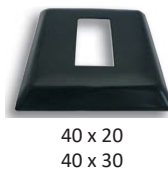

40 x 20
40 x 30

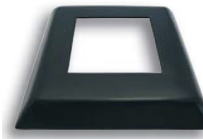

30 x 30
40 x 40
50 x 50
60 x 60



70 x 70
100 x 100

TIENDA



Base nivelante con cuña

			REF.
6	30 x 30	Blanco	H3007-9016
6	30 x 30	Negro	H3007-9005
6	30x 30	Especial	H3007-RAL
6	40 x 20	Blanco	H3008-9016
6	40 x 20	Negro	H3008-9005
6	40 x 20	Especial	H3008-RAL
6	40 x 40	Blanco	H3009-9016
6	40 x 40	Negro	H3009-9005
6	40 x 40	Especial	H3009-RAL



30 x 30



40 x 20



40 x 40

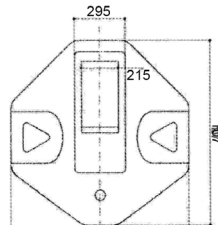

TIENDA



Base de aluminio triangular para exteriores

			REF.
6	30 x 30	Blanco	H3007-9016
6	30 x 30	Negro	H3007-9005
6	30x 30	Especial	H3007-RAL
6	40 x 20	Blanco	H3008-9016
6	40 x 20	Negro	H3008-9005
6	40 x 20	Especial	H3008-RAL
6	40 x 40	Blanco	H3009-9016
6	40 x 40	Negro	H3009-9005
6	40 x 40	Especial	H3009-RAL



40 x 40



40 x 20



30 x 30

TIENDA



Tapón embellecedor cubre tornillos



TIENDA

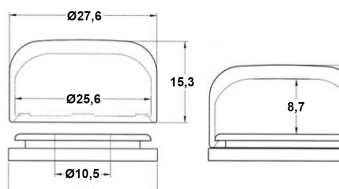

		REF.
50	Blanco	H3035-9016
50	Negro	H3035-9005

Fija barandillas a pared



TIENDA

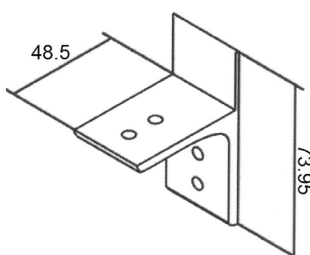

	DESCRIPCIÓN		REF.
10	Fija barandillas a pared	Blanco	H3020-9016
10	Fija barandillas a pared	Negro	H3020-9005
10	Fija barandillas a pared	Especial	H3020-RAL
10	Fija barandillas cortado	Blanco	H3021-9016
10	Fija barandillas cortado	Negro	H3021-9005
10	Fija barandillas cortado	Especial	H3021-RAL
10	Fija tubo Ø45 a Ø60	Blanco	H3022-9016
10	Fija tubo Ø45 a Ø60	Negro	H3022-9005
10	Fija tubo Ø45 a Ø60	Especial	H3022-RAL

Soporte normal de pasamanos



TIENDA

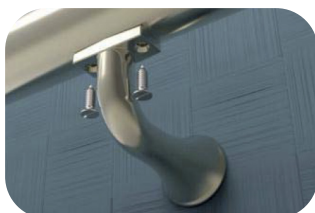

		REF.
12	Blanco	H3036-9016
12	Negro	H3036-9005
12	Plata	H3036-9006

Soporte alto de pasamanos



TIENDA



		REF.
12	Blanco	H3037-9016
12	Negro	H3037-9005
12	Especial	H3037-RAL

Apoyo intermedio. Altura: 90mm





TIENDA



		REF.
12	Blanco	H3038-9016
12	Negro	H3038-9005
12	Especial	H3038-RAL

Altura: 90mm

Soporte de aluminio remate vidrio

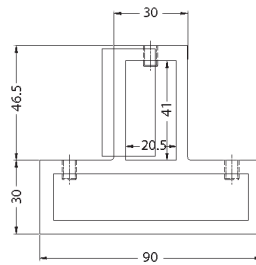

			REF.
40	-	Blanco	H3039-9016
40	-	Negro	H3039-9005
40	-	Especial	H3039-RAL



TIENDA



Tapón 40x20 (ref. H3041)

			REF.
40	-	Blanco	H3059-9016
40	-	Negro	H3059-9005
40	-	Especial	H3059-RAL

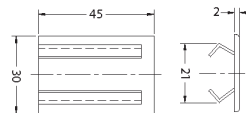

TIENDA



Soporte de aluminio para tubo

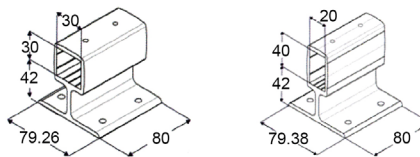

			REF.
12	30 x 30	Blanco	H3040-9016
12	30 x 30	Negro	H3040-9005
12	30 x 30	Especial	H3040-RAL
12	40 x 20	Blanco	H3041-9016
12	40 x 20	Negro	H3041-9005
12	40 x 20	Especial	H3041-RAL



TIENDA



Anclaje forjado tubo 40x20 corto.

			REF.
20	-	Blanco	H3058-9016
20	-	Negro	H3058-9005
20	-	Especial	H3058-RAL

TIENDA



Soporte remate vidrio regulable.

			REF.
20	-	Blanco	H3042-9016
20	-	Negro	H3042-9005
20	-	Especial	H3042-RAL

TIENDA



Junta en U de nylon para vidrio 8mm

			REF.
20	8 mm	-	H3043
20	10 mm	-	H3044

TIENDA

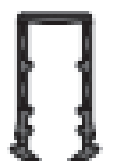

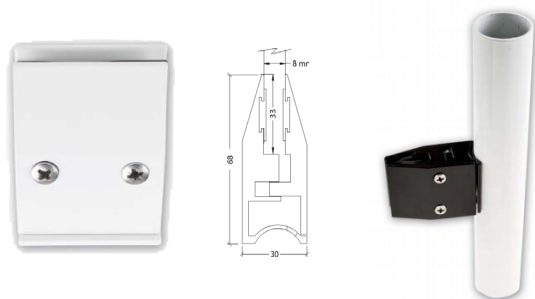

TIENDA



Pinza horizontal con asiento

			REF.
20	-	Blanco	H3097-9016
20	-	Negro	H3097-9005
20	-	Especial	H3097-RAL

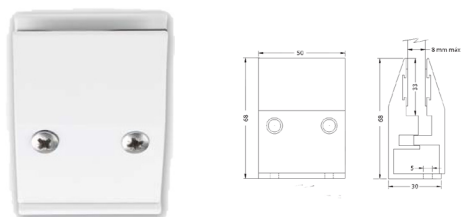

TIENDA



Pinza horizontal

			REF.
20	8 mm	Blanco	H3046-9016
20	8 mm	Negro	H3046-9005
20	8 mm	Especial	H3046-RAL
20	11 mm	Blanco	H3096-9016
20	11 mm	Negro	H3096-9005
20	11 mm	Especial	H3096-RAL

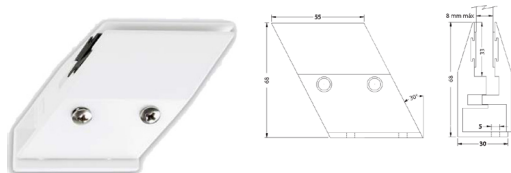

TIENDA



Pinza inclinada

	POSICIÓN		REF.
20	Derecha	Blanco	H3047-9016
20	Derecha	Negro	H3047-9005
20	Derecha	Especial	H3047-RAL
20	Izquierda	Blanco	H3048-9016
20	Izquierda	Negro	H3048-9005
20	Izquierda	Especial	H3048-RAL

Fijacristales modelo "Sena" y modelo "Rhin".



TIENDA



	MODELO		REF.
24	Sena	Blanco	H3045-9016
24	Sena	Negro	H3045-9005
24	Sena	Especial	H3045-RAL
24	Rhin	Blanco	H3049-9016
24	Rhin	Negro	H3049-9005
24	Rhin	Especial	H3049-RAL
24	Conversor	Blanco	H3050-9016
24	Conversor	Negro	H3050-9005
24	Conversor	Especial	H3050-RAL

Compensador de aluminio para perfiles de barandilla





TIENDA



			REF.
30	60	Blanco	H3055-9016
30	60	Negro	H3055-9005
30	60	Especial	H3055-RAL
22	66	Blanco	H3056-9016
22	66	Negro	H3056-9005
22	66	Especial	H3056-RAL
12	60	Blanco	H3057-9016
12	60	Negro	H3057-9005
12	60	Especial	H3057-RAL

Compensador de aluminio para tubo

			REF.
30	40	Blanco	H3051-9016
30	40	Negro	H3051-9005
30	40	Especial	H3051-RAL
22	50	Blanco	H3052-9016
22	50	Negro	H3052-9005
22	50	Especial	H3052-RAL
12	60	Blanco	H3053-9016
12	60	Negro	H3053-9005
12	60	Especial	H3053-RAL

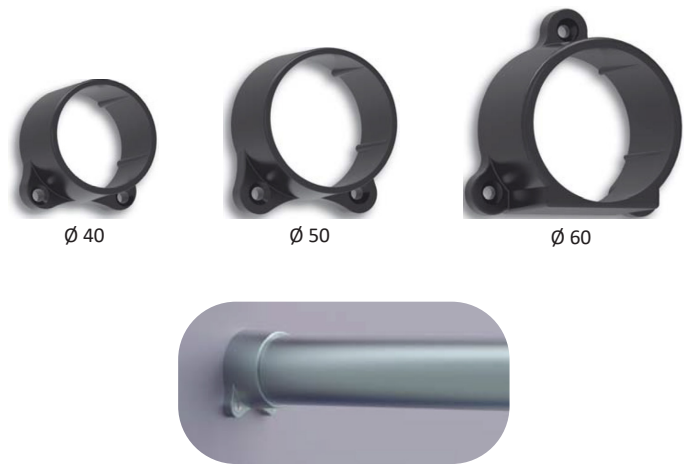



Tapas de aluminio para barandillas

Tapas barandillas redonda

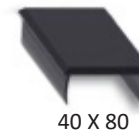
			REF.
56	Ø40 (plana)	Blanco	H3060-9016
56	Ø40(plana)	Negro	H3060-9005
56	Ø40(plana)	Especial	H3060-RAL
56	Ø40	Blanco	H3061-9016
56	Ø40	Negro	H3061-9005
56	Ø40	Especial	H3061-RAL
32	Ø50	Blanco	H3062-9016
32	Ø50	Negro	H3062-9005
32	Ø50	Especial	H3062-RAL
32	Ø60	Blanco	H3063-9016
32	Ø60	Negro	H3063-9005
32	Ø60	Especial	H3063-RAL



Tapas barandillas rectangular

			REF.
50	40 x 20	Blanco	H3064-9016
50	40 x 20	Negro	H3064-9005
50	40 x 20	Especial	H3064-RAL
50	40 x 40	Blanco	H3065-9016
50	40 x 40	Negro	H3065-9005
50	40 x 40	Especial	H3065-RAL
50	40 x 60	Blanco	H3066-9016
50	40 x 60	Negro	H3066-9005
50	40 x 60	Especial	H3066-RAL
32	40 x 80	Blanco	H3067-9016
32	40 x 80	Negro	H3067-9005
32	40 x 80	Especial	H3067-RAL
20	40 x 100	Blanco	H3068-9016
20	40 x 100	Negro	H3068-9005
20	40 x 100	Especial	H3068-RAL
20	40 x 120	Blanco	H3069-9016
20	40 x 120	Negro	H3069-9005
20	40 x 120	Especial	H3069-RAL



Remates para pasamanos

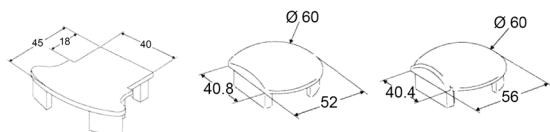
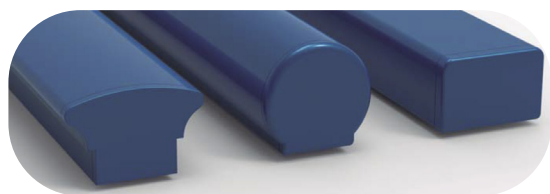

		\varnothing	TIPO DE "U"		REF.
60	-	-	-	Blanco	H3070-9016
60	-	-	-	Negro	H3070-9005
60	-	-	-	Especial	H3070-RAL
60	-	-	-	Blanco	H3071-9016
60	-	-	-	Negro	H3071-9005
60	-	-	-	Especial	H3071-RAL
50	-	60	40	Blanco	H3072-9016
50	-	60	40	Negro	H3072-9005
50	-	60	40	Especial	H3072-RAL
50	-	66	51	Blanco	H3073-9016
50	-	66	51	Negro	H3073-9005
50	-	66	51	Especial	H3073-RAL
50	60 x 40	-	40	Blanco	H3074-9016
50	60 x 40	-	40	Negro	H3074-9005
50	60 x 40	-	40	Especial	H3074-RAL
50	60 x 40	-	51	Blanco	H3075-9016
50	60 x 40	-	51	Negro	H3075-9005
50	60 x 40	-	51	Especial	H3075-RAL

TIENDA



Remate piramide plana



			REF.
24	60 x 60	Blanco	H3076-9016
24	60 x 60	Negro	H3076-9005
24	60 x 60	Especial	H3076-RAL
20	70 x 70	Blanco	H3077-9016
20	70 x 70	Negro	H3077-9005
20	70 x 70	Especial	H3077-RAL

TIENDA



Remate piramide

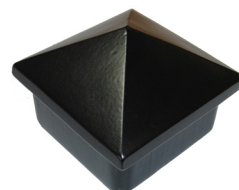



			REF.
24	60 x 60	Blanco	H3078-9016
24	60 x 60	Negro	H3078-9005
24	60 x 60	Especial	H3078-RAL
20	70 x 70	Blanco	H3079-9016
20	70 x 70	Negro	H3079-9005
20	70 x 70	Especial	H3079-RAL
12	80 x 80	Blanco	H3080-9016
12	80 x 80	Negro	H3080-9005
12	80 x 80	Especial	H3080-RAL
36	100 x 100	Blanco	H3081-9016
36	100 x 100	Negro	H3081-9005
36	100 x 100	Especial	H3081-RAL

TIENDA



Remate de bola

			REF.
12	40 x 40	Blanco	H3082-9016
12	40 x 40	Negro	H3082-9005
12	40 x 40	Especial	H3082-RAL
7	60 x 60	Blanco	H3083-9016
7	60 x 60	Negro	H3083-9005
7	60 x 60	Especial	H3083-RAL
4	80 x 80	Blanco	H3084-9016
4	80 x 80	Negro	H3084-9005
4	80 x 80	Especial	H3084-RAL

TIENDA



Remate punta de lanza

				REF.
50	20 x 20	-	Blanco	H3085-9016
50	20 x 20	-	Negro	H3085-9005
50	20 x 20	-	Especial	H3085-RAL
50	-	30	Blanco	H3086-9016
50	-	30	Negro	H3086-9005
50	-	30	Especial	H3086-RAL
50	-	32	Blanco	H3087-9016
50	-	32	Negro	H3087-9005
50	-	32	Especial	H3087-RAL

TIENDA



Escuadras para barandillas

	DESCRIPCIÓN	TIPO DE "U"		REF.
25	Regulable	40mm	Bruto	H3088
50	Fija	40mm	Bruto	H3090

TIENDA

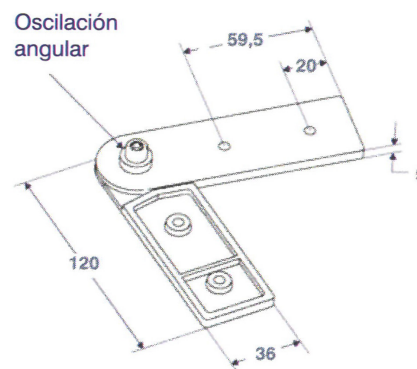
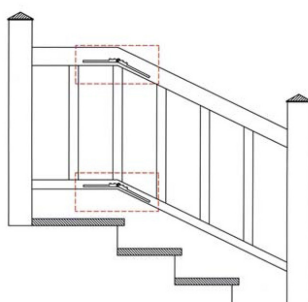
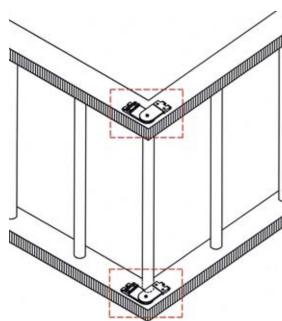

Escuadra Fija

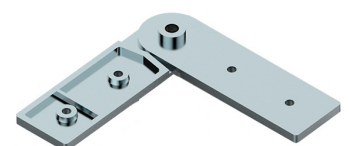

Escuadra Regulable

Tapa de media luna para vallas

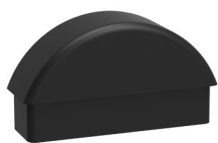

60 x 20
Plástico



60 x 20
Aluminio





60 x 40
Aluminio



60 x 60
Aluminio

TIENDA



	MATERIAL			REF.
100	Plástico	60 x 20	Blanco	H3091-9016
-	Plástico	60 x 20	Negro	H3091-9005
-	Aluminio	60 x 20	Blanco	H3092-9016
-	Aluminio	60 x 20	Negro	H3092-9005
-	Aluminio	60 x 40	Blanco	H3093-9016
-	Aluminio	60 x 40	Negro	H3093-9005
-	Aluminio	60 x 60	Blanco	H3094-9016
-	Aluminio	60 x 60	Negro	H3094-9005





Juego tapas punta de flecha para vallas



60 X 20
PLÁSTICO



	MATERIAL			REF.
100	Plástico	60 x 20	Blanco	H3095-9016
100	Plástico	60 x 20	Negro	H3095-9005

TIENDA



Guías para corredera de aluminio

	DESCRIPCIÓN	REF.
10	Juego SF-A40 accesorios 40Kg	98850
5	Juego SF-A61 accesorios 61Kg	94426
5	Juego SF-A81 accesorios 81Kg	94326
1	Juego SF-A126 accesorios 126Kg	94328
10	Perfil superior SF-A40 galvanizado	98848
5	Perfil superior SF-A60/A80 aluminio	94324
5	Perfil superior SF-A125 aluminio	94325



TIENDA



GUIADOR INFERIOR



SOPORTE PARED



PERFIL SUPERIOR DE ALUMINIO



PLETINA REGULACIÓN (SOBREPUESTA)



SOPORTE TAPETA



TOPE Y FRENO



PLETINA REGULACIÓN (ENCASTRADA)





FRENO RETENEDOR



ROLDANAS CON TORNILLOS



Guías para corredera de vidrio

	DESCRIPCIÓN			REF.
5	Juego SV-A60 accesorios 60Kg	-	-	94330
1	Juego SV-A100 accesorios 100Kg	-	-	98856
5	Perfil superior SV-A60/A80	3m	Plata	94324
5	Perfil superior SV-A100/A125	3m	Plata	96162



TIENDA



FRENO Y RETENEDOR



JUEGO ROLDANAS



PERFIL INFERIOR



PINZAS REGULABLES



PERFIL SUPERIOR



SOPORTE TAPETA SV



GUIADOR INFERIOR

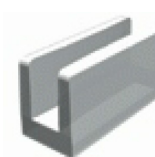

Garra de ventana

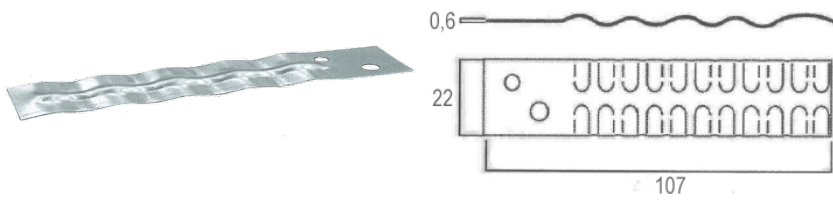

	REF.
1.500	78573

Garra de puerta

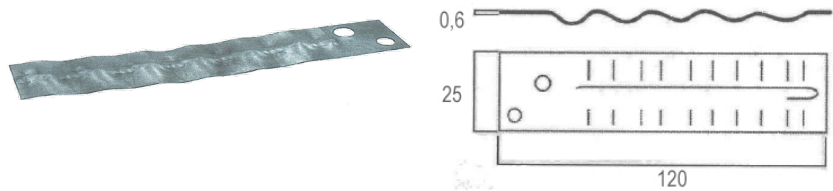

	REF.
1.200	78574

Premarco 2416

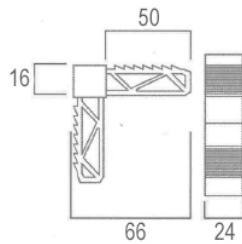

	REF.
400	40 x 20 99125

Premarco 3716

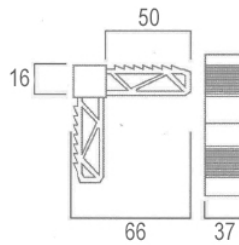

	REF.
300	40 x 40 98821

Premarco no recuperable

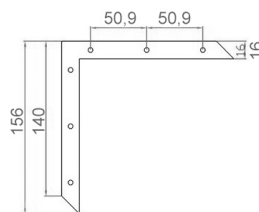
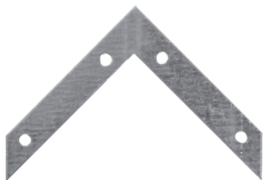

	REF.
300	99580

Cartabón metálico

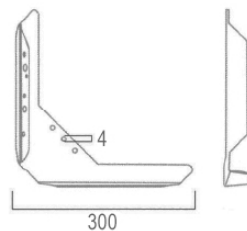
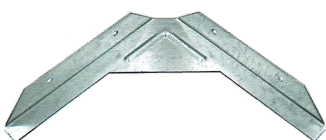

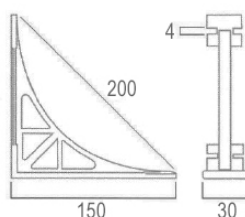

	REF.
300	99085

Cartabón nylon



	REF.
200	- 98822

Calzos de acristalar





COLOR		MEDIDA			REF.
BLANCO	1.000	1,5mm	4,00	272 x 255 x 230	P2410
AMARILLO	1.000	2mm	3,50	272 x 255 x 230	99656
ROJO	1.000	3mm	3'60	272 x 255 x 230	P2411
AZUL	500	4mm	3'20	272 x 255 x 230	99658
VERDE	1000	5mm	3,30	272 x 255 x 230	P2412
NEGRO	500	6mm	3,40	272 x 255 x 230	99660
GRIS	350	8mm	3,75	272 x 255 x 230	99661
DORADO	250	10mm	3,60	272 x 255 x 230	99710
VERDE	250	12mm	3,70	272 x 255 x 230	95196
ROSA	250	14mm	3,80	272 x 255 x 230	99662



TIENDA



Calzos de acristalar regulables

				REF.
18 mm	270	2,80	290 x 250 x 160	P2901
24 mm	200	2,80	290 x 250 x 160	P2902
28 mm	150	2,80	290 x 250 x 160	P2903
32 mm	150	2,90	290 x 250 x 160	P2904
42 mm	100	2,90	290 x 250 x 160	P2905

TIENDA



Häusen®

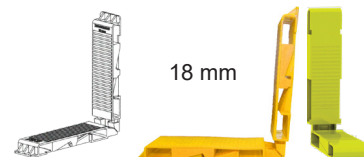

18 mm

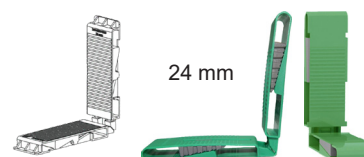

24 mm

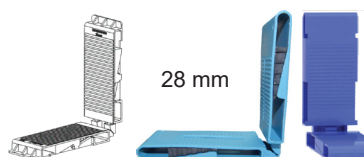

28 mm

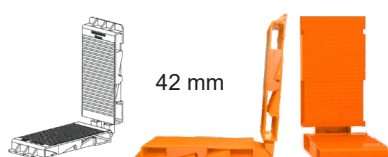

42 mm

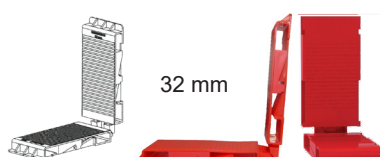

32 mm



Alicates para la regulación de los calzos

	REF.
1	P0034





TIENDA



Häusen®



Vierteaguas

RAL		MEDIDAS			REF.
9016	50	35 mm	0,25	290 x 250 x 160	H7035-9016
9005	50	35 mm	0,25	290 x 250 x 160	H7035-9005
9005	50	30 mm	0,25	290 x 250 x 160	85255
9005	50	31 mm	0,25	290 x 250 x 160	85256
9005	50	26,5 mm	0,25	290 x 250 x 160	85257
9005	50	45 mm	0,25	290 x 250 x 160	85258

TIENDA



Häusen®

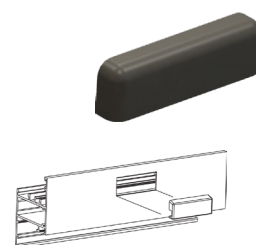

Häusen®

Tapón embellecedor



TIENDA



RAL				REF.
9016	100	0,17	290x250x160	H7028-9016
9005	100	0,17	290x250x160	H7028-9005

Häusen®

Punto de apoyo hoja



TIENDA



				REF.
2	1.000	6,10	315x235x245	P4108

Häusen®

Cortavientos



TIENDA



RAL					REF.
9016	2	1.000	5,20	315x235x245	P3201-9016

Häusen®

Formón desbarbador modelo lápiz

Cuerpo de plástico, reducido tamaño para poder llevarlo en un bolsillo



TIENDA



	REF.
1	T0006

Fiberschnitt

Cortavidrios 6 rulinas

Mango de madera barnizada



TIENDA



	REF.
1	83476

Häusen®

Rascavidrios hoja trapezoidal

Cuerpo de plástico, cuchilla trapezoidal incluida



TIENDA



	REF.
1	80998

Häusen®

Paleta para calzar vidrio y acristalar



TIENDA



	REF.
1	P0033
1	99841

Tijeras corta ingletes

Mango con goma antideslizante

DESCRIPCIÓN		REF.
Tijeras corta ingletes	1	T0001
Repuesto cuchilla	1	T0008
Base medidora de ángulos	1	T0009

TIENDA



Tijeras corta ingletes

Mango de goma antideslizante, cuchilla trapezoidal intercambiable

DESCRIPCIÓN		REF.
Tijeras corta ingletes	1	T0002
Cuchilla trapezoidal 60mm	10	T0004

TIENDA

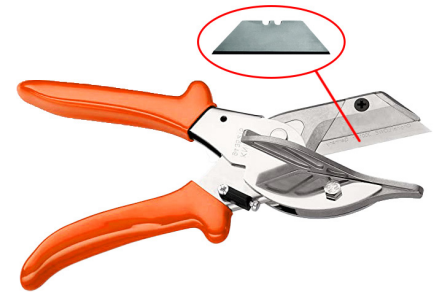

Tijeras corte recto

Mango con goma antideslizante

	REF.
1	T0007

TIENDA



Tijeras corte angular de gomas

Mango con goma antideslizante

	REF.
1	T0003

TIENDA



Rulinas para goma

Mango de plástico antideslizante

DESCRIPCIÓN		REF.
Rulina goma central	1	R0001
Rulina goma mosquitera	1	R0002
Rulina goma acristalar	1	R0003

TIENDA



R0001



R0002



R0003



Refrigerante para máquinas de corte

Aceite refrigerante especial para máquinas tronzadoras y centros de trabajo CNC

TIENDA



	USO	TI	REF.
1	Centros CNC	5 litros	M0062
1	Centros CNC	20 litros	M0061
1	Tronzadoras	20 litros	M0060

Sellador Sealant

Ideal para sellar los ingletes de carpintería de aluminio, PVC, madera o acero inoxidable



TIENDA



RAL		TI	REF.
Blanco	24	310ml	94128
Transparente	24	310ml	78519
Blanco	12	500ml	94129
Transparente	12	500ml	95464

Limpiador Aluminio o PVC

Limpiador en profundidad de las superficies de PVC o de aluminio lacado, especialmente en color blanco



TIENDA



	USO	TI	REF.
1	PVC	500ml	94491
1	Aluminio	500ml	78509
1	Aluminio	5 litros	99219



Pinel de retoque para aluminio

Pintura con pinel aplicador para retoques de pequeños desperfectos en aluminio



TIENDA



	TI	RAL		REF.
1	12ml	9016	Blanco	78305
1	12ml	8014	Marrón sepia	94509
1	12ml	6005	Verde musgo	30615
1	12ml	6009	Verde abeto	92849
1	12ml	9006	Plata	78303
1	12ml	7048	Gris perla	94427
1	12ml	8017	Chocolate	78306
1	12ml	9011	Negro grafito	49346
1	12ml	7016	Antracita	92961



Pintura en spray para aluminio

Pintura en aerosol especial para pintar objetos metálicos que pueden ser dañados por el calor



TIENDA



	TI	RAL		REF.
1	400ml	9010	Blanco	92611
1	400ml	9017	Negro	78093
1	400ml	9006	Plata	78150
1	400ml	7016	Antracita	78091

GOMAS Y JUNTAS PVC Y ALUMINIO

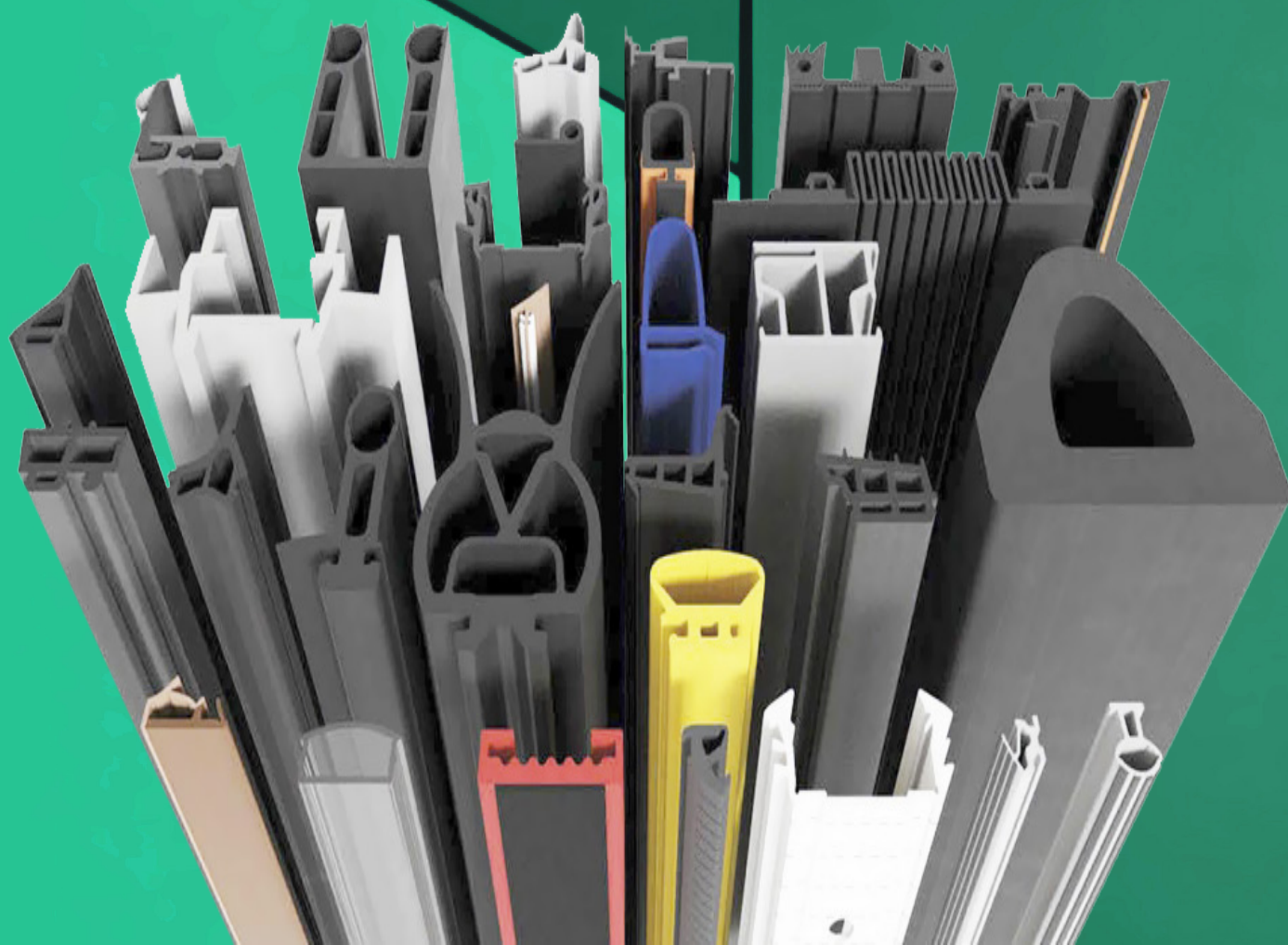

JUNTAS DE ACRISTALAR

TIENDA

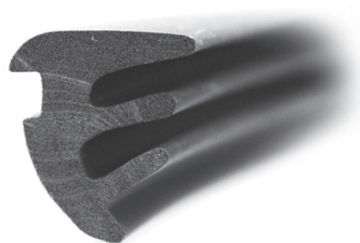

	HUECO	Nº	REF.
Negro	2mm	80	G2001
Amarillo	2,5mm	90	G2002
Rojo	3mm	100	G2003
Blanco	4mm	120	G2004
Negro	5mm	140	G2005
Verde	6mm	180	G2006
Gris	7mm	210	G2007
Azul	8mm	230	G2008
Rosa	9mm	250	G2009
Naranja	10mm	260	G2010



2mm



3mm

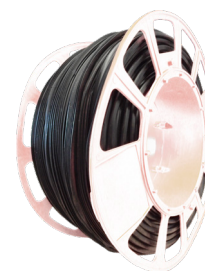

4mm



5mm



6mm



7mm



8mm



9mm



10mm

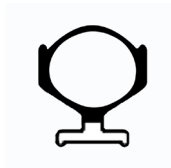

SERIES DISPONIBLES

- Alumed
- Codeval
- Grupo Sopena
- Hierros Játiva
- Hierros Játiva C-16
- Extol C-16
- Extrual
- Aluval
- Sistemas Cortizo
- Anicolor
- Itesal
- Aluminios Barcelona

JUNTAS PARA MOSQUITERAS

TIPO	Ø	MATERIAL	REF.
Junta mosquitera	5 mm	PVC	98550
Junta mosquitera	5,5 mm	PVC	98551
Junta mosquitera	6 mm	PVC	98552
Junta mosquitera	6,5 mm	PVC	98553
Junta mosquitera	7 mm	PVC	98554

TIENDA

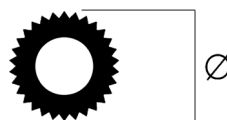

GOMAS PARA BANCOS DE TRABAJO

TIPO	REF.
Junta blanda	98555
Junta semirígida	98556

TIENDA



Junta semirígida
98556



Junta blanda
98555



TIENDA



Cinta autoexpansiva de poliuretano para ventanas Soudaband Pro BG1

Cinta de espuma flexible de PU precomprimida e impregnada en resina sintética.



		ANCHO CINTA	PRECOMPRESIÓN	EXPANSIÓN	REF.
Pack 30 rollos	20 m	10 mm	± 1 mm	1 - 2 mm	H6503
Pack 25 rollos	12 m	12 mm	2 mm	2 - 6 mm	H6504
Pack 20 rollos	13 m	15 mm	± 1,5 mm	1 - 4 mm	H6505
Pack 20 rollos	12 m	15 mm	2 mm	2 - 6 mm	H6506
Pack 20 rollos	8 m	15 mm	± 4,5 mm	4 - 9 mm	H6501
Pack 20 rollos	6 m	15 mm	5 mm	5 - 12 mm	H6502
Pack 20 rollos	4 m	15 mm	± 6,5 mm	6 - 15 mm	H6500
Pack 15 rollos	13 m	20 mm	± 1,5 mm	1 - 4 mm	H6507
Pack 15 rollos	12 m	20 mm	2 mm	2 - 6 mm	H6508
Pack 15 rollos	8 m	20 mm	± 4,5 mm	4 - 9 mm	H6509
Pack 15 rollos	4 m	20 mm	± 5,5 mm	6 - 15 mm	H6510
Pack 15 rollos	3 m	20 mm	9 mm	9 - 20 mm	H6511
Pack 8 rollos	3,3 m	35 mm	-----	18 - 38 mm	H6512



TIENDA



Cinta autoexpansiva para ventanas Soudaband Aktiv Plus

Cinta de sellado precomprimida y multifuncional impregnada en una resina sintética que impermeabiliza las uniones contra la presión del viento y la lluvia de mas de 600 Pa.



		ANCHO CINTA	EXPANSIÓN	REF.
Pack 5 rollos	5,6 m	54 mm	5 - 10 mm	H6520
Pack 5 rollos	4,6 m	54 mm	7 - 15 mm	H6521
Pack 5 rollos	3,3 m	54 mm	10 - 20 mm	H6522
Pack 4 rollos	5,6 m	64 mm	5 - 10 mm	H6523
Pack 4 rollos	4,3 m	64 mm	7 - 15 mm	H6524
Pack 4 rollos	3,3 m	64 mm	10 - 20 mm	H6525
Pack 4 rollos	5,6 m	74 mm	5 - 10 mm	H6526
Pack 4 rollos	4,3 m	74 mm	7 - 15 mm	H6527
Pack 4 rollos	3,3 m	74 mm	10 - 20 mm	H6528
Pack 3 rollos	5,6 m	84 mm	5 - 10 mm	H6529
Pack 3 rollos	4,3 m	84 mm	7 - 15 mm	H6530
Pack 3 rollos	3,3 m	84 mm	10 - 20 mm	H6531



TIENDA



Cinta autoexpansiva para ventanas Soudaband Aktiv Plus PA

Cinta de sellado precomprimida y multifuncional impregnada en una resina sintética que impermeabiliza las uniones contra la presión del viento y la lluvia de mas de 600 Pa. Igual que la Aktiv Plus pero con un ancho de perfil mas reducido.



		ANCHO CINTA	EXPANSIÓN	REF.
Pack 10 rollos	30 m	20 mm	5 - 10 mm	H6532
Pack 10 rollos	15 m	20 mm	7 - 15 mm	H6533
Pack 6 rollos	30 m	30 mm	5 - 10 mm	H6534
Pack 6 rollos	15 m	30 mm	7 - 15 mm	H6535
Pack 5 rollos	30 m	40 mm	5 - 10 mm	H6536
Pack 5 rollos	15m	40 mm	7 - 15 mm	H6537

Escuadras y uniones

- **ALDAL (INALUM)**
 - Perfiles Elevables
 - Perfiles Practicables
 - Perfiles Corredera
 - Perfiles Mallorquina
- **ALDECA**
 - Perfil Fijo Serie 45
- **ALUGOM**
 - Perfil Elevable
 - Perfil Abatible
 - Perfil Corredera
- **ALUMED**
 - Perfil Elevable
 - Perfil Abatible
 - Perfil Corredera
- **ALUVAL**
 - Perfil Elevable
 - Perfil Abatible
 - Perfil Corredera
- **AYUSO**
 - Perfil Elevable
 - Perfil Abatible
 - Perfil Corredera
- **CORTIZO**
 - Perfil Elevable
 - Perfil Abatible
 - Perfil Corredera
- **CUPRUM**
 - Perfil Practicable
 - Perfil Corrediza
- **EXTRALUM**
 - Corrediza Europa
 - Perfil Practicable
- **STRUGAL**
 - Perfil Elevable
 - Perfil Abatible
 - Perfil Corredera
- **EXLABESA**
 - Perfil Elevable
 - Perfil Abatible
 - Perfil Corredera
- **EXTRUSIONES TOLEDO**
 - Perfil Elevable
 - Perfil Abatible
 - Perfil Corredera

ESCUADRA ALDAL (INALUM)

Perfiles Elevables



	PERFIL	DESCRIPCIÓN	€	REF.
275	95005	HOJA PERIMETRAL RPT-135	Consultar	E6630
165	12004	HOJA ELEV-100	Consultar	E6631
165	46621	MARCO DECORATIVO ELEV-100	Consultar	E6631
165	12004	HOJA ELEV-100	Consultar	E6632

Perfiles Practicables



	PERFIL	DESCRIPCIÓN	€	REF.
150	40001	MARCO VTNA. 40x20	Consultar	E6793
150	40030	MARCO LISO 40x20	Consultar	E6795
150	40003	HOJA VTNA. 40x20	Consultar	E6796
120	40006	MARCO PTA. 40x20	Consultar	E6798
120	40007	HOJA PTA. 40x40	Consultar	E6799
165	47100	MARCO VTNA. DE 40 P-47	Consultar	E6714
165	47117	MARCO VTNA. DE 45 P-47	Consultar	E6715
144	47106	MARCO PTA. DE 40 P-47	Consultar	E6718
144	47118	MARCO PTA. DE 45 P-47	Consultar	E6719
165	47603	HOJA VTNA. RECTA P-47	Consultar	E6723
165	47802	HOJA VTNA. CRUBA P-47	Consultar	E6724

Perfil Corredera



	PERFIL	DESCRIPCIÓN	€	REF.
165	4004	MARCO TUBULAR DE C70	Consultar	E6633
165	47116	MARCO FIJO DECORATIVO C70	Consultar	E6634
165	50012	MARCO DECORATIVO C70	Consultar	E6635
165	18135	MARCO PERIMETRAL C70	Consultar	E6636

Perfil Mallorca



	PERFIL	DESCRIPCIÓN	€	REF.
150	1006	MARCO Y HOJA	Consultar	E6811
120	1029	MARCO PUERTA	Consultar	E6812
165	47138	HOJA MALLORQUINA NACO	Consultar	E6813
150	1015	MARCO LISO VTNA.	Consultar	E6815

ESCUADRA ALDECA

Perfil Fijo Serie 45



	TETÓN	DESCRIPCIÓN	€	REF.
150	REDONDO	ESC. HOJA PR 16	Consultar	E7513
150	REDONDO PARTIDO	ESC. HOJA PR 16	Consultar	E7514-P
220	REDONDO	ESC. MARCO O FIJO PR 14	Consultar	E7515
325	REDONDO	ESC. HOJA CORREDERA MARCO DE 70	Consultar	E7516
165	REDONDO	ESC. MARCO CORREDERA DE 70 Y MARCO 3 CARRILES	Consultar	E7517
275	REDONDO	ESC. MARCO 3 CARRILES CORREDERA DE 70	Consultar	E7518
325	REDONDO	ESC. HOJA CORREDERA DE 60	Consultar	E7519
325	REDONDO	ESC. MARCO CORREDERA DE 60	Consultar	E7520

ESCUADRA ALUVAL

Aluprom 15

	TETÓN	PERFIL	DESCRIPCIÓN	€	REF.
325	REDONDO	15200	MARCO CLIP 52	Consultar	E5319
325	REDONDO	15301	HOJA 60 CLIMALIT	Consultar	E5322
165	REDONDO	28271	MARCO FIJO 60 CON REGISTRO	Consultar	E5323

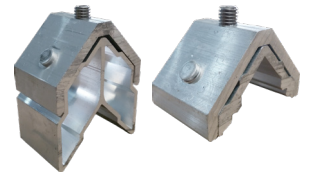

Aluprom 18

	TETÓN	PERFIL	DESCRIPCIÓN	€	REF.
325	REDONDO	18200	MARCO UNIVERSAL	Consultar	E5325
325	REDONDO	18303	HOJA CURBA CLIMALIT	Consultar	E5328
165	REDONDO	18203	MARCO DE 70	Consultar	E5330

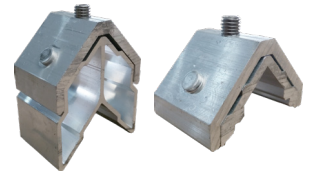

Aluprom 21

	TETÓN	PERFIL	DESCRIPCIÓN	€	REF.
165	REDONDO	28271	MARCO CON REGISTRO	Consultar	E5334
165	REDONDO	28272	MARCO FIJO 60 CON CLIP	Consultar	E5335



Aluprom 22 / 28

	TETÓN	PERFIL	DESCRIPCIÓN	€	REF.
165	REDONDO	22280	MARCO	Consultar	E5338
165	REDONDO	22281	MARCO CON PREMARCO	Consultar	E5339
165	REDONDO	22388	HOJA VENTANA	Consultar	E5340
100	REDONDO	23280	MARCO PUERTA	Consultar	E5343
100	REDONDO	23388	HOJA DE PUERTA	Consultar	E5344
100	REDONDO	23389	HOJA CAMARA 40	Consultar	E5347

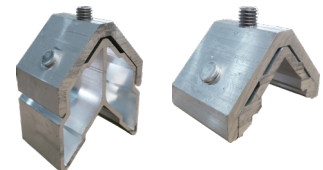

Aluprom 25

	TETÓN	PERFIL	DESCRIPCIÓN	€	REF.
275	REDONDO	5225260	MARCO CON PREMARCO	Consultar	E5407
275	REDONDO	5225280	MARCO VENTANA	Consultar	E5408
275	REDONDO	5225360	HOJA VENTANA	Consultar	E5409
180	REDONDO	5226280	MARCO PUERTA	Consultar	E5412
180	REDONDO	5226380	HOJA DE PUERTA	Consultar	E5413
180	REDONDO	5226581	HOJA APERTURA EXTERIOR	Consultar	E5414

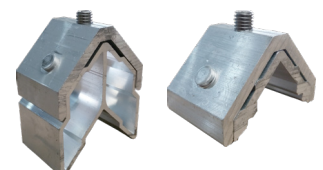

ESCUADRA EXTRALUM



Corrediza Europa



	TETÓN	PERFIL	DESCRIPCIÓN	€	REF.
275	REDONDO	EX1379	MARCO EUROPA CO	Consultar	E5458
165	REDONDO	EX1401	CONTRAMARCO 2 VIAS EUROPA CO	Consultar	E5459
275	REDONDO	EX1399	CONTRAMARCO 3 VIAS EUROPA CO	Consultar	E5460
275	REDONDO	EX1402	MARCO VERTICAL EUROPA CO	Consultar	E5461

Practicable para Abatible Europa



	TETÓN	PERFIL	DESCRIPCIÓN	€	REF.
165	REDONDO	EX1385	CONTRAMARCO EUROPA OB	Consultar	E5462
120	REDONDO	EX1387	CONTRAMARCO 45.00 EUROPA OB	Consultar	E5463
165	REDONDO	EX1390	MARCO APERTURA INTERNA 44.00 EUROPA OB	Consultar	E5464
144	REDONDO	EX1394	MARCO APERTURA EXTERNA INTERNA 83.60 EUROPA OB	Consultar	E5465
144	REDONDO	EX1395	MARCO APERTURA INTERNA INTERNA 64.60 EUROPA OB	Consultar	E5466
165	REDON. PARTIDO	EX1390	MARCO APERTURA INTERNA 44.00 EUROPA OB	Consultar	E5467-P
144	REDON. PARTIDO	EX1394	MARCO APERTURA EXTERNA INTERNA 83.60 EUROPA OB	Consultar	E5468-P
144	REDON. PARTIDO	EX1395	MARCO APERTURA INTERNA INTERNA 64.60 EUROPA OB	Consultar	E5469-P

Practicable para Vidrio Fijo Europa



	TETÓN	PERFIL	DESCRIPCIÓN	€	REF.
165	REDONDO	E5470	CONTRAMARCO CURBO VIDRIO FIJO EUROPA CO	Consultar	E5470

Practicable para Ventanas Puerta/Ventana Proyectante Europa



	TETÓN	PERFIL	DESCRIPCIÓN	€	REF.
165	REDONDO	EX1385	CONTRAMARCO EUROPA OB	Consultar	E5471
165	REDONDO	EX1393	MARCO APERTURA EXTERNA 66.70 EUROPA OB	Consultar	E5472
165	REDON. PARTIDO	EX1393	MARCO APERTURA EXTERNA 66.70 EUROPA OB	Consultar	E5473-P

Practicable para Ventanas Puerta/Ventana Proyectante Europa



	TETÓN	PERFIL	DESCRIPCIÓN	€	REF.
165	REDONDO	EX1385	CONTRAMARCO EUROPA OB	Consultar	E5474
165	REDONDO	EX1390	MARCO APERTURA INTERNA 44.00 EUROPA OB	Consultar	E5475
165	REDON. PARTIDO	EX1390	MARCO APERTURA INTERNA 44.00 EUROPA OB	Consultar	E5476-P

ESCUADRA CUPRUM

Practicable Fijo Serie 45

	TETÓN	PERFIL	DESCRIPCIÓN	€	REF.
165	REDONDO	62033	"L" CONTRAMARCO	Consultar	E5048

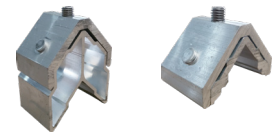

Practicable Fijo Serie 80

	TETÓN	PERFIL	DESCRIPCIÓN	€	REF.
165	REDONDO	62020	ESCALONADO	Consultar	E5049
165	REDONDO	62092	ESCALONADO 2 VIAS	Consultar	E5050
165	REDONDO	62093	ESCALONADO 2 VIAS + MOSQUITERO	Consultar	E5051
165	REDONDO	62094	ESCALONADO 3 VIAS	Consultar	E5052



Practicable Fijo Serie 150

	TETÓN	PERFIL	DESCRIPCIÓN	€	REF.
220	REDONDO	67734	CONTRAMARCO	Consultar	E5053
165	REDONDO	62026	"T" APERTURA EXTERIOR	Consultar	E5054

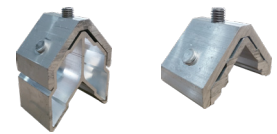

Practicable para Ventana Batiente y Protección S35 Americana C/E

	TETÓN	PERFIL	DESCRIPCIÓN	€	REF.
325	REDONDO	32273	DESCRIPCIÓN PERFIL	Consultar	E5041
325	REDONDO	32274	MARCO	Consultar	E5042
325	REDONDO	32276	MARCO COLONIAL	Consultar	E5043
325	REDONDO	42277	MARCO DOBLE VIDRIO	Consultar	E5044

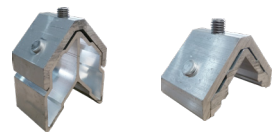

Practicable para Ventana Batiente y Protección S35 Americana C/E

	TETÓN	PERFIL	DESCRIPCIÓN	€	REF.
325	REDONDO	19171	CONTRAMARCO	Consultar	E5045
325	REDONDO	19172	MARCO COLONIAL	Consultar	E5046
325	REDONDO	19195	MARCO DOBLE VIDRIO	Consultar	E5047



Practicable para Ventana Serie 45

	TETÓN	PERFIL	DESCRIPCIÓN	€	REF.
165	REDONDO	62033	"L" CONTRAMARCO	Consultar	E5068
165	REDONDO	62026	"T" APERTURA EXTERIOR	Consultar	E5069
165	REDONDO	62027	"Z" APERTURA INTERIOR	Consultar	E5070



Practicable para Puerta Serie 45

	TETÓN	PERFIL	DESCRIPCIÓN	€	REF.
100	REDONDO	62033	BATIENTE	Consultar	E5072
100	REDONDO	62046	CERCO CHAPA	Consultar	E5073



Practicable para Puerta Serie 45 Camara Europea

	TETÓN	PERFIL	DESCRIPCIÓN	€	REF.
165	REDONDO	62033	"L" CONTRAMARCO	Consultar	E5071





Corrediza Fijo Serie 60

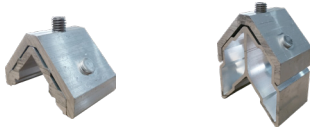

	TETON	Perfil	DESCRIPCIÓN	€	REF.
260	REDONDO	62079	FIJO ESCALONADO	Consultar	E5038

Ventana Corrediza Serie 60



	TETON	Perfil	DESCRIPCIÓN	€	REF.
260	REDONDO	62067	RIEL OX	Consultar	E5039
260	REDONDO	62067	RIEL XX	Consultar	E5040

Corrediza Serie 80

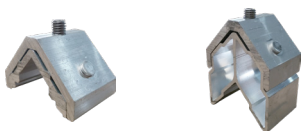

	TETON	Perfil	DESCRIPCIÓN	€	REF.
165	REDONDO	62000	RIEL BÁSICO	Consultar	E5055
165	REDONDO	62017	RIEL TRIPLE	Consultar	E5056
325	REDONDO	62001	CERCO 6 mm	Consultar	E5057
325	REDONDO	62004	CERCO DUO 18 mm	Consultar	E5058
325	REDONDO	62019	MOSQUITERO DE LUJO	Consultar	E5059
325	REDONDO	64207	ADAPTADOR RIEL	Consultar	E5060
325	REDONDO	64614	CERCO 6 mm REFORZADO	Consultar	E5061
325	REDONDO	63207	CERCO 18 mm REFORZADO	Consultar	E5062

Corrediza Serie 150



	TETON	Perfil	DESCRIPCIÓN	€	REF.
220	REDONDO	62052	RIEL DOBLE	Consultar	E5037
165	REDONDO	62054	RIEL TRIPLE	Consultar	E5063
165	REDONDO	62055	CERCO 6 mm	Consultar	E5064
165	REDONDO	62056	CERCO DOBLE VIDRIO 24 mm	Consultar	E5065
165	REDONDO	62057	MOSQUITERO	Consultar	E5066
165	REDONDO	62091	ADAPTADOR RIEL	Consultar	E5067

STRUGAL

Serie S70RP

	TETON	Perfil	DESCRIPCIÓN	€	REF.
220	REDONDO	6200	MARCO	Consultar	E6218
220	REDONDO	6204	HOJA PUERTA	Consultar	E6222
220	REDONDO	6205	HOJA APERTURA EXTERIOR PUERTA	Consultar	E6223
220	REDONDO	6219	HOJA VENTANA	Consultar	E6224

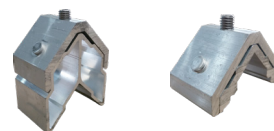

Serie S60RP

	TETON	Perfil	DESCRIPCIÓN	€	REF.
220	REDONDO	6111	MARCO	Consultar	E6229
220	REDONDO	6118	HOJA VENTANA	Consultar	E6233
220	REDONDO	6116	HOJA APERTURA EXTERIOR PUERTA	Consultar	E6234
220	REDONDO	6115	HOJA PUERTA	Consultar	E6235

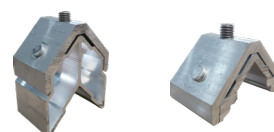

Serie S46

	TETON	Perfil	DESCRIPCIÓN	€	REF.
150	REDONDO	4728	MARCO VENTANA RECTO	Consultar	E6279
120	REDONDO	4670	MARCO PUERTA RECTO	Consultar	E6280
120	REDONDO	4796	HOJA PUERTA RECTA	Consultar	E6285
150	REDONDO	4703	HOJA VENTANA RECTA	Consultar	E6286
150	REDONDO	4232	HOJA VENTANA CURVA	Consultar	E6293
120	REDONDO	4395	HOJA PUERTA CURVA	Consultar	E6294

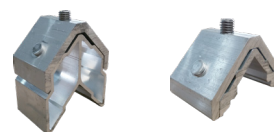

Serie S125 RP

	TETON	Perfil	DESCRIPCIÓN	€	REF.
150	REDONDO	6703	MARCO PERIMETRAL	Consultar	E6348
150	REDONDO	6702	MARCO FIJO	Consultar	E6349
200	REDONDO	6701	HOJA PERIMETRAL	Consultar	E6350

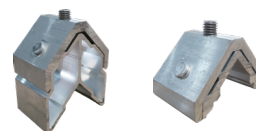

Serie S90 RP

	TETON	Perfil	DESCRIPCIÓN	€	REF.
330	REDONDO	489	MARCO PERIMETRAL	Consultar	E6353
330	REDONDO	491	MARCO FIJO	Consultar	E6354
330	REDONDO	4352	ADAPTADOR 3 CARRILES	Consultar	E6358



Serie S90 RP

	TETON	Perfil	DESCRIPCIÓN	€	REF.
150	REDONDO	4916	MARCO PERIMETRAL	Consultar	E6368
150	REDONDO	70120	MARCO PERIMETRAL	Consultar	E6369
330	REDONDO	4930	ADAPTADOR 3 CARRILES	Consultar	E6371

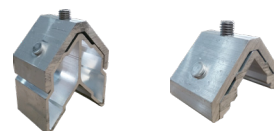

Escuadras Exlabesa

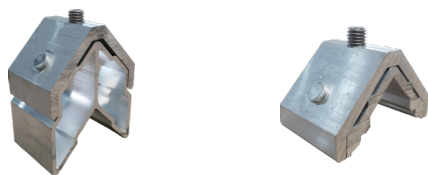

	DESCRIPCIÓN	REF.
200	Hoja ventana apertura exterior	E6034
150	Inversora pivotante PR-7400 TR	E5996
150	Hoja ventana curva TR serie PR-7000	E4840

Escuadras Sopena

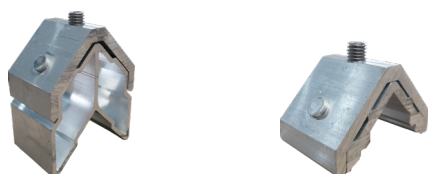

	DESCRIPCIÓN	REF.
100	Serie V-94 hoja balconera TR (7036-EC)	E6524
165	Serie V-98 maco ventana TR	E6545
96	Serie V-94 puerta mediana EC (7037-EC)	E6508
150	Serie V-94 ventana 16 EC	E6499

Escuadras Strugal

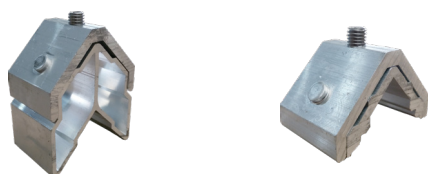

	DESCRIPCIÓN	REF.
150	Strugal S40 hoja ventana	E6327

Escuadras Alumafel

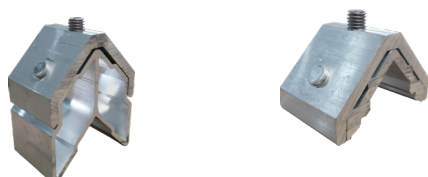

	DESCRIPCIÓN	REF.
200	Forma Thermic (abisagrada)	E7909
150	Forma Thermic (abisagrada)	E7916
100	Forma Puerta (abisagrada)	E7899

Escuadras Alumed

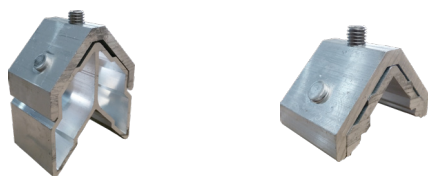

	DESCRIPCIÓN	REF.
250	Hoja perimetral GP65 TR	E5079
96	Marco GP45 puerta 40/45	E5181

Escuadras Cortizo

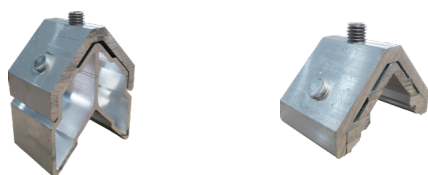

	DESCRIPCIÓN	REF.
96	Serie 2300 abisagrada hoja ventana	E8188

EXTRUSIONES DE TOLEDO

Abatible Serie 1200

	TETON	Perfil	DESCRIPCIÓN	REF.
150	REDONDO	1200	CERCO VENTANA	E5512
150	REDONDO	1201	HOJA VENTANA	E5513
150	REDONDO	1100	CERCO VENTANA	E5517
150	REDONDO	1101	HOJA VENTANA	E5518
150	REDONDO	1103	HOJA SIN JUNQUILLO	E5519
120	REDONDO	1053	CERCO VENTANA	E5523
120	REDONDO	1054	HOJA VENTANA	E5524

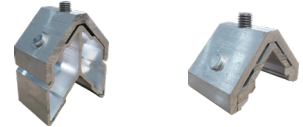

Abatible Serie 3600

	TETON	Perfil	DESCRIPCIÓN	REF.
165	REDONDO	3600	CERCO VENTANA	E5533
120	REDONDO	3605	HOJA VENTANA	E5534
165	REDONDO	3603	HOJA VENTANA APERTURA EXTERIOR	E5537
120	REDONDO	3607	HOJA PUERTA APERTURA EXTERIOR	E5539

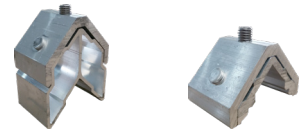

Abatible Serie 5400

	TETON	Perfil	DESCRIPCIÓN	REF.
165	REDONDO	5402	CERCO VENTANA	E5551
120	REDONDO	5400	HOJA VENTANA	E5552
165	REDONDO	5403	HOJA VENTANA CURBA	E5558
120	REDONDO	5410	HOJA DE PUERTA CURBA	E5559

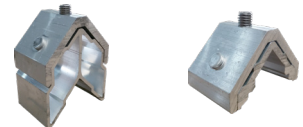

Corredera Serie 3700

	TETON	Perfil	DESCRIPCIÓN	REF.
165	REDONDO	3706	CERCO PERIMETRAL	E5678
275	REDONDO	3711	SUPLEMENTO TRICARRIL PARA CERCO 3706	E5681
325	REDONDO	3701	HOJA PERIMETRAL 22 mm	E5683
325	REDONDO	3702	HOJA PERIMETRAL 10 mm	E5684

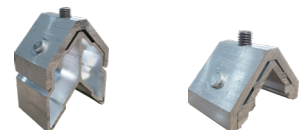

Corredera Serie 3750

	TETON	Perfil	DESCRIPCIÓN	REF.
325	REDONDO	3750	CERCO PERIMETRAL	E5689
325	REDONDO	3751	HOJA PERIMETRAL H10 mm	E5691
165	REDONDO	6458	FIJO MARCO 60 mm S-3600	E5695
165	REDONDO	5662	FIJO MARCO 60 mm S-5600	E5696

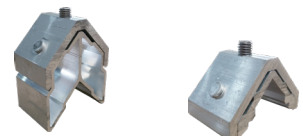

Escuadras muelle de fundición

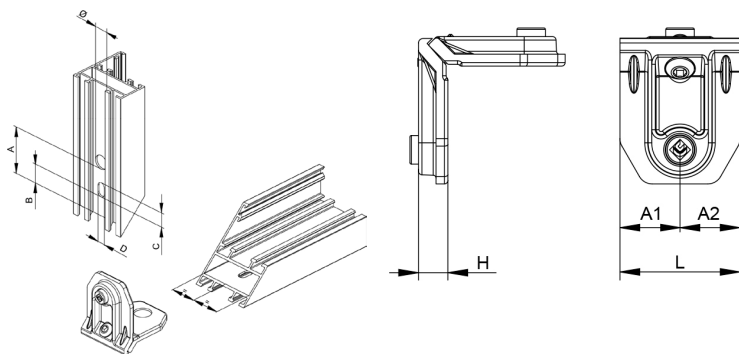

	DESCRIPCIÓN	REF.
-	Aldal P70 - 0331	E9200
-	Franco P70 - 0331	E9201
-	Alfil - 0314	E9202
-	Extrugasa V8000 - 58 - 0332	E9203
-	Alugom Stylo 50 - 0333	E9204
-	Aldal P47 - 0334	E9205
-	Cortizo 2300 - 0334	E9206
-	Teleprofil - 0335	E9207
-	Ayuso Eurothermic - 0335	E9208
-	Magnum 400 - 0335	E9209
-	Ayuso Magnum 200 - 0338	E9210
-	Laminex - 0338	E9211
-	P70 - 0343	E9212
-	Aldal p 47 puerta - 0348	E9213
-	Domal Slide - 0364	E9214



Unión Europea cerrada



	DESCRIPCIÓN	REF.
100	C/11 1118	92716
100	C/14 U-1418	99216
100	C/15 1518	98749
100	C/ 16 U-1618	92714
100	C/26 2618	92359
100	C/30 U-3018	94355
100	C/36 3618	92715

Unión Europea abierta



	DESCRIPCIÓN	REF.
100	C/11 UA-1118	94457
100	C/14 UA-1418	92785
100	C/15 UA-1518	92788
100	C/36 UA-3618	92789

Unión Cerrada



	DESCRIPCIÓN	REF.
100	40 x 20 / 37 x 16 / 3716	98800
100	40 x 40 / 37 x 36 / 3716	98750

Unión abierta

	DESCRIPCIÓN	REF.
200	40 x 20 / 37 x 16 / UA-3716	78429
100	40 x 40 / 37 x 36 / UA-3716	99246

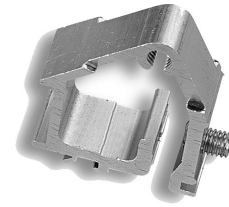

Escuadra Europea L5

	DESCRIPCIÓN	REF.
200	40 x 20 / L5-3716-C	98748
100	40 x 40 / L5-3736-C	98799



Escuadra Europea L8

	DESCRIPCIÓN	REF.
200	40 x 18 L8-3714-C	88816
200	40 x 20 L8-3714-125	92677
200	40 x 18 L8-3714-150	92680
200	40 x 20 L8-3716-C	98728
200	40 x 20 L8-3716-150	92722
200	40 x 20 L8-3031-C	94356
200	40 x 35 L8-3731-125	92681
200	L8-3731-C	92717
200	L8-3736-C	98747
200	L8-3736-150	92723



Escuadra graduable

	DESCRIPCIÓN	REF.
100	Graduable 40 x 18 LG-3714-C	99245

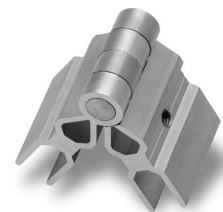

Matrices de escuadras

	DESCRIPCIÓN	REF.
1	Matriz manual	Consultar
1	Matriz neumática	Consultar

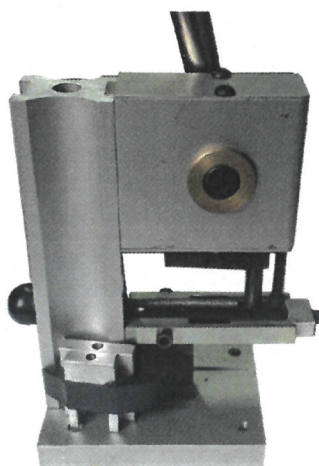

Matriz manual

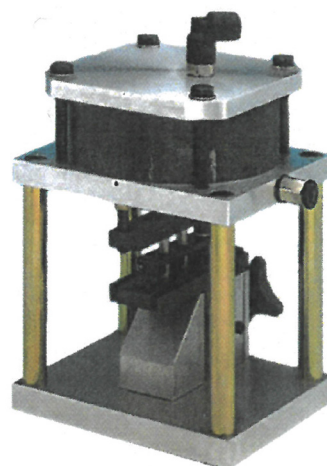

Matriz neumática





FP12 - Ref: 88637

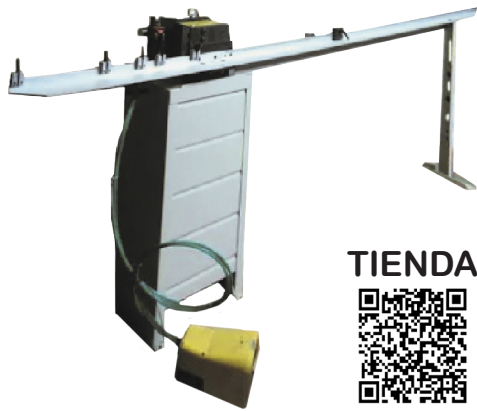

CONSULTAR OFERTA MÁQUINAS
PLETINA FALLEBA C.E.

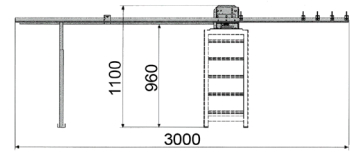

TIENDA



1685		10x14.5	1
		12x15	
		13.6x16.8	
		14x18	
	C.E.		

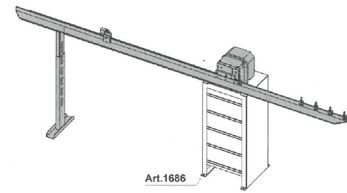

FP13 - Ref: 99636



TIENDA



CONSULTAR OFERTA MÁQUINAS
PLETINA FALLEBA C.E.

1684		1
	C.E.	

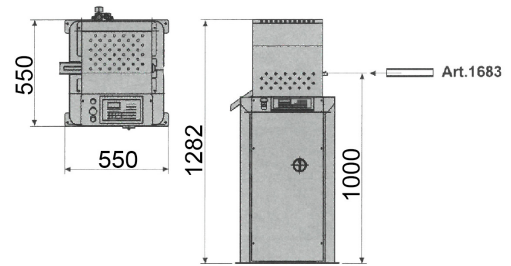

Pletina falleba de poliamida



TIENDA



	REF.
250 metros	99639

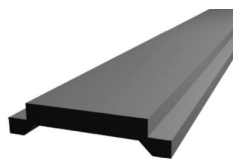

Pletina falleba C.E. de fibra de vidrio



TIENDA



	REF.
250 metros	H7045

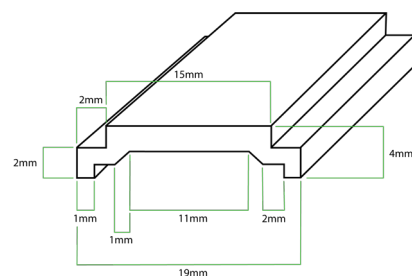

Abrepuertas eléctricos	135, 136, 137,138	Cierrapuertas hidráulicos	139, 140, 141
Acoples de cerradura	85	Cierres de presión	101
Acoples de rodillos	84	Cierres embutidos corredera	60
Adaptador O.B.	105	Cilindros	79, 80, 83, 84
Aireadores	117, 118	Cintas autoexpansivas	176
Ángulos reenvío	38, 39	Claraboyas	120, 121
Antipánicos	68, 69, 70, 71, 72, 73	Clip de retención	42
Aperturas a distancia	125, 126	Compás automático "Raptor"	44
Asas	111	Compás retenedor C.E.	44, 67
Automatismos	128, 129, 130, 131	Contactos eléctricos puertas	138
		Contracierres corredera	64, 65
Bajopuertas automáticos	143, 144, 145	Corredera-Elevable "Leo"	18, 19, 20
Barandillas	158, 159, 160, 161	Corredera-Traslante "Swing"	12, 13, 14, 15
Barandillas	162, 163, 164	Cortavidrios	170
Bisagra compás 40x20	32	Cortavientos	170
Bisagras 40x20	32	Cremonas C.E.	87, 88, 89
Bisagras C.E.	45, 46, 47, 48	Cremonas Fapim	106, 107, 108, 109
Bisagras compás C.E.	44, 67	Cuadrillos	85
Bisagras de muelle	142	Cunas de empalme	41
Bisagras de proyectante	66	Escaleras escamoteables	124
Bisagras de vaivén	142	Escuadras	177, 178, 179, 180, 181, 182
Bisagras pivotante 40x20	32	Escuadras	183, 184, 185, 186, 187
Bisagras pivotantes C.E.	43	Escuadras de barandillas	165
BlickDomi	128		
Bocallaves	110	Falso compas	36
		Formón	170
Calzos de acristalar	169	Frenos de puerta	142
Calzos de multipunto	52		
Cartabones	168	Garras	168
Cerraderos C.E.	40, 41, 42	Golpetes 40x20	32
Cerraderos de corredera	52, 53	Golpetes C.E.	43
Cerraderos de pasadores	35	Gomas	173, 174, 175
Cerraderos para cerraduras	85, 86	Gomas bancos trabajo	175
Cerradura automática "Domo"	74, 75	Guías para correderas	167
Cerraduras de bloqueo	85		
Cerraduras de corredera	59	Juntas de acristalar	174
Cerraduras de puertas	76, 77, 78, 80, 81, 82, 83	Juntas de mosquitera	175
Cerraduras eléctricas	84		

Kit ventanas francesas	43	Premarcos	168
Kits cerraderos C.E.	35	Puertas blindadas THT	132, 133
Kits de corredera	59	Puntos apoyo hoja	170
Kits pasadores	35, 36, 37, 38	Puntos de cierre bulón	41, 42
Laterales y dinteles puertas	134	Rascavidrios	170
Limpiador aluminio	172	Refrigerante máquinas	172
Limpiador PVC	172	Rejillas	118, 120
Lothus	29, 30, 31	Remates	164, 165
 		Ruedas de corredera	54, 61, 62, 63, 64
Manillas de cuadradillo	90, 91, 92, 93, 94	Rulinas para goma	171
Manillas de cuadradillo	95, 96, 97, 98, 99, 102	 	
Manillas desplazadas	100, 101	Sellador Sealant	172
Manillas escudo largo	102, 103, 104	 	
Manillas ocultas	101	Tacos	156, 157
Máquinas oscilo-batiente	188	Tapas para vallas	166
Microventilación	42	Tapones de plástico	43, 170
Motores de cadena	127	Tapones para tornillos	155
Muelles de brazo	142	Tijeras corte inglete	171
Muletillas	85	Tiradores inox	112, 113, 114, 115, 116
Multipuntos	54, 55, 56, 57, 58	Tirafondos	154, 155
 		Topes de corredera	60
Oscilo-Batiente C-16	9, 10, 11	Tornillos DIN 7504	148, 149, 150
Oscilo-Batiente PVC	6, 7, 8	Tornillos DIN 7981	151, 152
Oscilo-Batiente Galicube	27	Tornillos DIN 7982	152, 153
Oscilo-Batiente Galiplus 2	28	Tornillos hormigón	155
Oscilo-Batiente oculto "Zenit"	23, 24, 25, 26	Tornillos junquillo	147
Oscilo-Paralela "Kondor"	16, 17	Tornillos PVC	146, 147
Pasacables flexibles	138	Uñas de corredera	65
Pasador Atlas	86	 	
Pasadores	33, 34, 35	Ventanas de techo	122, 123
Pinceles de retoque	172	Vierteaguas	169
Pinturas en spray	172		
Plantillas bisagras Loira	49		
Plegables "Orión"	21, 22		
Pletina falleba C.E.	49, 188		
Practicable 40x20	32		

ANOTACIONES

A series of horizontal dotted lines for taking notes.



camii

